

A METRICAL THEORY OF STRESS RULES

by

BRUCE PHILIP HAYES

A.B., Harvard College

(1976)

SUBMITTED IN PARTIAL FULFILLMENT
OF THE REQUIREMENTS FOR THE
DEGREE OF

DOCTOR OF PHILOSOPHY

at the

MASSACHUSETTS INSTITUTE OF TECHNOLOGY

June, 1980

© Bruce Philip Hayes 1980

The author hereby grants to M.I.T. permission to reproduce
and to distribute copies of this thesis document in whole
or in part.

Signature of Author

Department of Linguistics and Philosophy
May 28, 1980

Certified by

Morris Halle
Thesis Supervisor

Accepted by

Samuel Jay Keyser
Chairman, Departmental Committee

ARCHIVES
MASSACHUSETTS INSTITUTE
OF TECHNOLOGY

JUN 11 1980

A METRICAL THEORY OF STRESS RULES

by

BRUCE PHILIP HAYES

Submitted to the Department of Linguistics and Philosophy
on May 28, 1980 in partial fulfillment of the requirements
for the Degree of Doctor of Philosophy

This thesis tries to characterize the class of unmarked stress rules. The approach I have taken is metrical: stress is represented as a matter of relative prominence, using the tree notation proposed by Mark Liberman. I have also assumed two further developments of Liberman's theory. The first is the introduction of a separate level of metrical feet, allowing us to dispense with the feature [+stress]. The second is a theory of syllable internal structure, which makes it possible to represent distinctions of prominence among syllables geometrically, as the difference between branching and non-branching nodes. Using these notions, I claim that an unmarked stress rule must construct trees that are drawn from a highly restricted inventory of possible tree geometries, defined by constraints on whether or not the various nodes of the tree may branch. I further claim that in the great majority of cases, the labeling of the trees to determine the relative prominence of their nodes is carried out by one of two unmarked labeling conventions.

Some further ideas presented in the thesis are the following: (a) The notion of dominant and recessive nodes is introduced, and shown to simplify the formulation of the unmarked tree construction and labeling rules. (b) A constrained theory of extrametricality is developed, which provides a better account for cases which would otherwise require an expanded theory of unmarked tree geometry. (c) A precise universal formulation of Stray Syllable Adjunction is proposed and motivated empirically.

To support the theory, the stress systems of Akkadian, Tiberian Hebrew, Yiddish, and English are analyzed in some detail. Numerous other languages are discussed briefly to illustrate how the rules predicted as unmarked by the theory are in fact frequently attested.

Thesis Supervisor: Morris Halle

Title: Ferrari P. Ward Professor of Modern
Languages and Linguistics

Acknowledgements

The most enjoyable part of writing this thesis was the opportunity to discuss its contents with the faculty and students at M.I.T. and elsewhere. I am glad to take the opportunity to thank everyone involved for their kind assistance.

The members of my committee, Morris Halle, Paul Kiparsky, and Jay Keyser, were unfailingly generous with their time, suggestions, and encouragement. Most of what I know about phonology I learned from them, and their ideas are found in every part of this dissertation.

Special thanks go to Alan Prince, for some very sharp observations and comments. His suggestions resulted in numerous improvements, particularly in Chapter 5.

Many other people, including David Nash, Jane Simpson, John McCarthy, Janet Pierrehumbert, Donca Steriade, Tim Stowell, Phil LeSourd, Mohanan, David Pesetsky, Shelly Lieber, Ann Farmer, Ken Hale, Jim Harris, and Joan Bresnan, were a great help, either by discussing the material presented here, by providing moral support, or indirectly by teaching me to be a better linguist. Thanks to them all. Thanks as well to Chris and to M. Speakers, my favorite English informants.

This thesis is dedicated to my parents, with love and gratitude.

Table of Contents

Acknowledgements	3
Chapter 1: Background	
1. Introduction	6
2. Liberman and Prince's Theory	6
3. Syllables and Feet	14
4. The Theory of Syllable Weight	24
5. Outline and Miscellanea	31
Footnotes	35
Chapter 2: Stress in Aklan	
1. Preliminaries	36
2. Analysis	37
3. Theoretical Consequences	56
Footnotes	65
Chapter 3: Tree Geometry	
1. Tree Geometry as the Central Part of Metrical Theory	66
2. The Problem of Syllable Quantity	69
3. A Theory of Tree Geometry	78
4. Exemplification	85
4.1 Binary Quantity Insensitive Trees	86
4.2 Unbounded Quantity Insensitive Trees	95
4.3 Unbounded Quantity Sensitive Trees	96
4.4 Binary Quantity Sensitive Trees	99
4.5 Trees in which Dominant Nodes must Branch	105

5. Feet with Extra Final Nodes	110
6. Other Kinds of Extrametricality	129
7. Stress in Tiberian Hebrew	134
8. Conclusion	168
Footnotes	170
Chapter 4: Labeling Rules	
1. Common Labeling Conventions	174
2. Rarer Labeling Rules	187
3. Stress in Yidin ^y	196
4. Conclusion	226
Footnotes	228
Chapter 5: Where Does English Fit In?	
1. Introductory	229
2. Extrametricality Rules in English	236
3. Stress Retraction	246
4. The Phonological Cycle	257
5. Two Destressing Rules	271
6. Non-Maximal Foot Construction	280
7. Further Adjectival Suffixes	283
8. Cases of the Type <u>Winnepesaukee</u>	287
9. A Constraint on Destressing Rules	303
10. Prefix-Stem Words and the Strict Cycle	304
11. Ternary Feet Across $\check{V}\check{V}$ and the i-y Rule	318
12. Conclusion	330
Footnotes	331
Bibliography	333
Biographical Note	340

Chapter 1: Background

1. Introduction

This thesis is based on a line of research that is several years old, and which has evolved rapidly since its beginnings. I will begin with a discussion of this work in order to point out what I believe to be its most important contributions, and to make things clearer for the reader who is unfamiliar with its claims. The uninitiated are urged, however, to read the relevant articles, for which my summary account will only be a poor substitute. In particular, I will be dwelling for the most part on the large scale arguments, which point out how a given theory captures generalizations about language in general; rather than discussing the nuts-and-bolts type of argument, in which a given framework is shown to provide an insightful account of a particular set of facts in a given language.

2. Liberman and Prince's Theory

The seminal work on metrical theory is Liberman and Prince (1977), which is a thorough development of ideas first presented in Liberman (1975). Liberman and Prince proposed a radical revision for the representation of stress. In earlier works, stress was represented as a property of single vowels: Trager and Smith (1951), for example, proposed four phonemic levels of stress in English, notated in descending order of prominence as ' , ^ , \ , and ∪ . Chomsky and Halle (1968) adopted a similar system, with integers to replace

Trager and Smith's symbols, and used it to great effect in their analysis of stress in English. Liberman and Prince, by contrast, proposed that stress is to be represented as a matter of relative prominence among syllables, rather than as a degree of absolute prominence attached to each vowel. Relative prominence is expressed in the theory using binary branching tree structures, in which each pair of sister nodes is labeled s w or w s, depending on which node is the stronger:

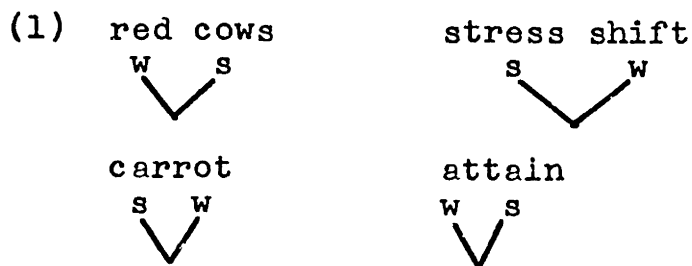

The labeling is intended to have a purely relative meaning -- an s or a w occurring in isolation over a single syllable would be uninterpretable. The theory handles cases with more than two syllables by allowing non-terminal constituents as well as syllables to be specified for relative strength, as in (2):

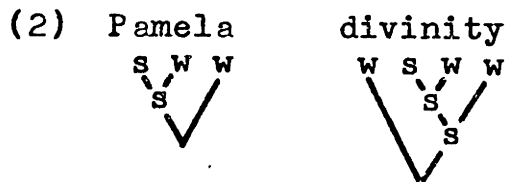

In (2), as elsewhere, the syllable that is dominated exclusively by s's is interpreted as having the strongest stress. Words having more than one stress, as in (3):

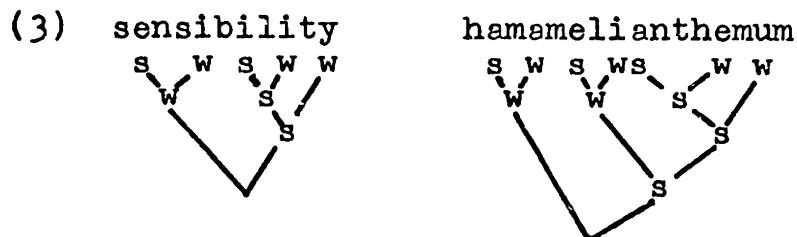

also fit into the system: the main stress of a word falls on the syllable dominated only by s's, while the other metrically strong syllables receive secondary stress.

There are some prominence distinctions in English which this simple mode of representation can't handle: compare for example the stress on the first syllables of banana and bandanna or the final syllables of rabbi and happy, Panama and Pamela. The ranking of prominence among the syllables of these examples is clearly the same:

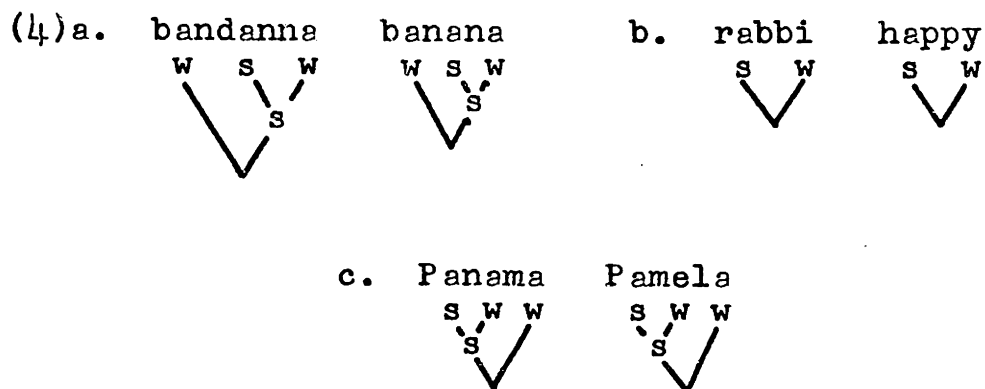

but the degree of stress differentiation is different.

Liberman and Prince took this as evidence that the segmental feature [+stress] must be retained in the theory, albeit with

a greatly reduced role, and only with binary values. With the stress feature, the examples of (4) can be distinguished:

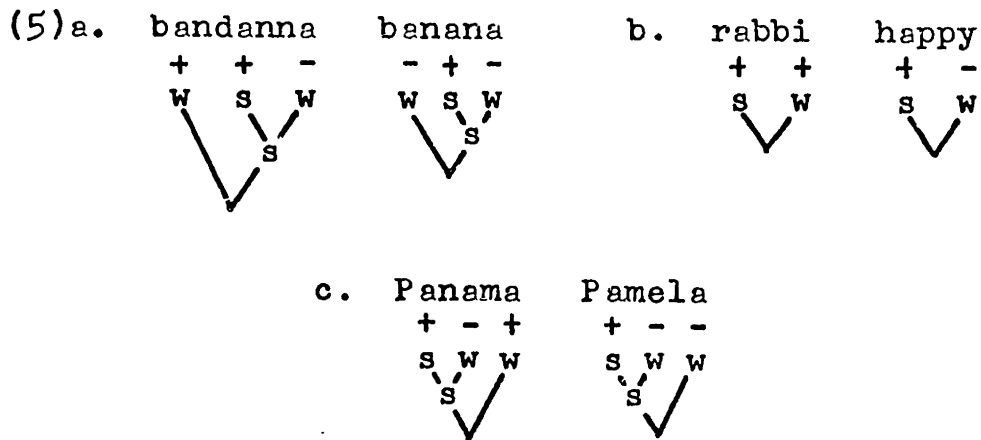

The feature [+stress] also plays a role in the construction of the metrical trees in Liberman and Prince's theory: trees are viewed as the concomitant of an ordinary segmental stress rule, taking roughly the form (6):

$$(6) \quad V \rightarrow [+stress] / __ C_0 ((\check{V}(C)) \check{V}C_0) \left\{ \begin{matrix} \# \\ [+stress] \end{matrix} \right\}$$

(applies iteratively)

With each iteration of the rule, metrical structure is created over the syllable that has just been stressed, plus the syllables that have been skipped over. The exact form of the tree constructed is dictated by the constraint that [-stress] syllables may not be dominated by s. In the derivation of hamamelianthemum, for example, the first iteration of the rule would produce the following structure:

(7) hamamelianthemum

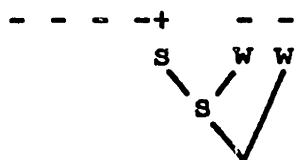

In the second and third iterations of the rule, one of the parenthesized expressions is idiosyncratically suppressed, so that the sub-trees have just two syllables:

(8) hamamelianthemum

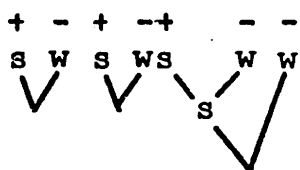

The prominence distinctions among the stressed syllables are determined by incorporating them into a higher level structure, in which only right nodes may branch. The nodes of this structure are labeled by a very simple principle:

- (9) Label a pair of sister nodes as *w s* if the right node branches, otherwise as *s w*.

Rule (9) results in the distinction between hamamelianthemum on one hand, and rigamarole on the other:

(10) hamamelianthemum

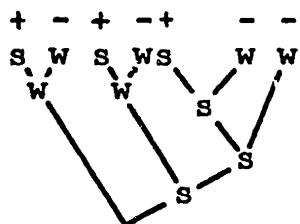

rigamarole

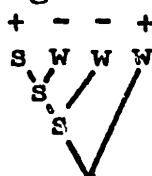

It accounts for the fact that in general, the main stress in English words falls on the last stressed syllable that isn't

in final word position.

The second stress in hamamelianthemum is generally perceived to be weaker than the first; in segmental notation we would have ^{3 4 1}hamamelianthemum. This follows not from a direct s w relationship between the two, but rather a general principle that the prominence of weak constituents is inversely proportional to their depth of embedding: the w that most closely dominates ham is "one node down" in the tree, whereas the closest node to mel is embedded under two nodes. The single constituent structure of (9) thus represents all the crucial information about relative prominence in the word.

This, in barest outlines, is Liberman and Prince's scheme. Aside from its advantages in analyzing the details of the English stress pattern, Liberman and Prince adduce a number of rather general arguments for their system. These can be reduced to two basic lines of reasoning: metrical structure provides a more rational representation for stress, and it provides an explanation for why stress rules behave differently from other rules.

Metrical trees are a better representation for stress for this reason: unlike other features, stress is not realized locally, but requires at least two syllables to establish a contour of prominence. This is an entirely natural result under a theory which represents stress as relative prominence, but is an embarrassment for a theory that equates a feature [+stress] with locally realized features such as [+high] or [+coronal]. In particular, the

theory is at a loss to explain why non-primary stress values such as [2stress] or [4stress] cannot occur on syllables in isolation. In addition, the segmental theory cannot explain why it is only among rules of stress assignment that numerical feature values play a crucial role in higher level phonological rules--among other rules, numerical features seem to be needed only at a late, phonetic stage of the derivation. Under the metrical theory, the phonological number two is respected--there are only two stress values, + and -, and two "values" for node labeling--s w and w s. The multiple perceptual stress values derive from the occurrence of these binary values in tree structures.

The other theoretical argument that backs Liberman and Prince's proposals is that they are a step on the way to the goal of making phonological rules local. In most normal cases, phonological rules affect a small, well defined section of the phonological string. Under a segmental framework, stress rules are a blatant counterexample to this pattern. They often involve essential variables, as in the English Compound Stress Rule:

$$(11) \begin{bmatrix} v \\ 1 \text{ stress} \end{bmatrix} \rightarrow [1 \text{ stress}] / \underline{\quad} Q(\#\#P)]_{N,A,V}$$

Conditions: Q contains no [1 stress]

P contains no ##

In addition, the stress subordination convention (Chomsky and Halle 1968) is eminently non-local: it requires all stresses in a domain to weaken by one when [1stress] is assigned to another vowel. It is obvious that such a convention could never be applied to segmental rules--for example, we would never expect to find a language in which all high vowels become somewhat less high phonetically whenever another vowel is made high, say before /y/. The metrical theory allows stress rules to be expressed in a way that is local in a fairly clear sense: the constituents that are being labeled may not be terminal, but on their own level they are adjacent. Thus the English compound rule may be stated as labeling the nodes of the syntactic bracketing as w s if the right sister branches, s w if it does not:

(12)a. law degree requirement changes

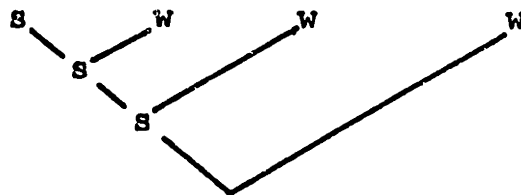

b. law degree language requirement

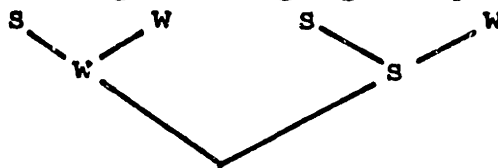

To summarize, the principal arguments for Liberman and Prince's theory are that it expresses stress as relative prominence, thereby eliminating the difficulties inherent in a numerical stress feature, and it rationalizes part of the

apparent non-local application of stress rules.

3. Syllables and Feet

Since the appearance of Liberman and Prince's work, two important advances have occurred. The first of these was developed by Prince himself in an early unpublished paper (1976), and in Selkirk (forthcoming). The newer proposal posits that the feature [+stress] can be eliminated from phonological theory, given a slight enrichment of metrical structure. Specifically, these authors proposed that the subtrees constructed by each iteration of the stress rule--referred to as metrical feet--be given an independent status in the theory, so that both phonological rules and principles of prominence interpretation may refer to them. Using feet, the representation of the words of (5) is as follows:

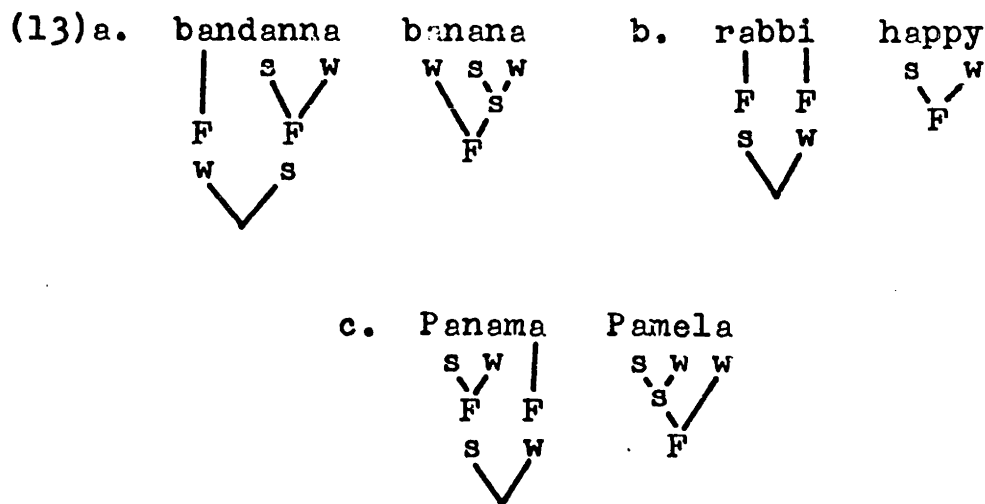

The stresses may be read off the trees in a simple way: we need only assume that the degree of subordination applying to syllables within a foot is greater than the prominence difference prevailing between feet. Using old terminology,

this means that each foot will contain one stressed syllable, while the main stressed syllable of a word is the strongest syllable of the strongest foot.

To simplify our representations, we will henceforth use diagrams in which the feet are separated by a horizontal line from the remaining structure, which will be called the word tree. The trees of (13) can thus be expressed equivalently as (14):

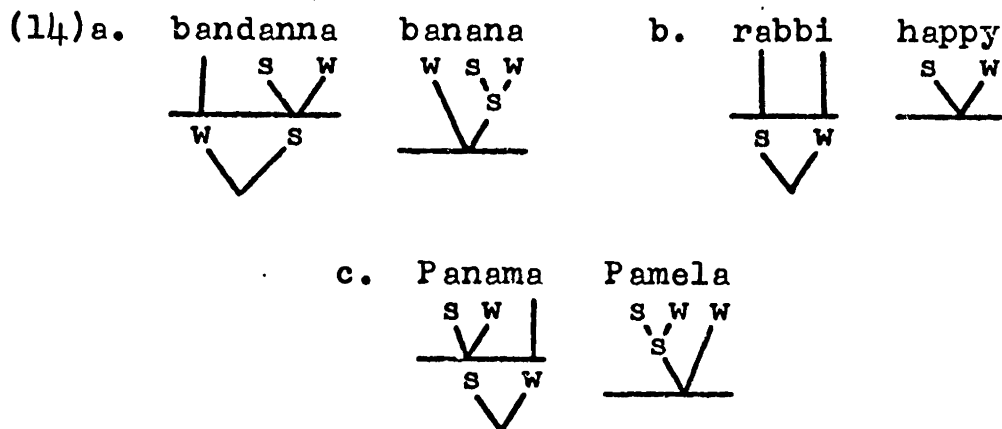

Under the new theory, the feature [+stress] is not available to determine the construction of trees. The theory thus resorts to a new artifice to determine tree construction: we restrict the type of syllables that the nodes of a well formed tree may dominate. As an example, we can state the stress rule of English roughly as follows:

(15) At the right edge of a word, construct the largest possible foot, subject to the following conditions:

- i. The foot is left branching, with sister nodes labeled s w.

- ii. The foot may not contain more than three syllables.
- iii. The rightmost weak syllable of the foot must not contain a tense vowel.
- iv. The remaining weak syllable, if there is one, must be light; i.e. of the form C_0V , where V is lax.

Rule (15) will construct the rightmost foot in words like labyrinth, pariah, conundrum, and marine as follows:

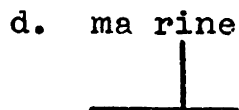
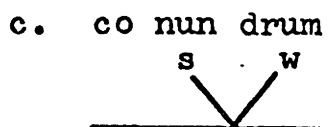
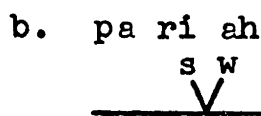
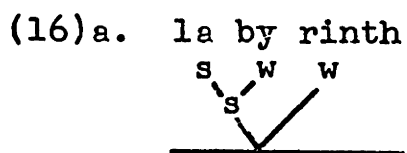

We will see later that there is good reason to revise this rule, but the example should make clear how the system works.

Notice that under the new theory, the syllable plays a crucial role. Phonologists had in fact suspected for some time that syllable divisions can be a determining factor in stress assignment--see for example Anderson and Jones (1974), McCawley (1974), and Kahn (1976). An example of a typical argument is the following: in English, short penultimate vowels may usually be skipped over by the stress rule provided that they precede only one consonant, as in America, Pamela,

militant, vs. fraternal, amalgam, reluctant, etc. However, there is a fairly systematic set of counterexamples to this pattern, typified by words like discipline, algebra, recalcitrant, and eloquent. Under the framework of Chomsky and Halle (1968), this necessitated a fairly complex description of the environment in which penultimate vowels could be skipped over:¹

$$(17) / \text{---} C_0^1 \left(\begin{array}{c} [\alpha \text{voc}] \\ [\alpha \text{cons}] \end{array} \right) V$$

In addition to its complication, Chomsky and Halle's proposal misses a fairly clear generalization: we can skip over the penultimate syllables of discipline, algebra, and eloquent simply because under the appropriate partitioning they are light syllables, while there is no syllable division that could make the penultimate syllables of fraternal and amalgam light. A rule containing the expression of (17) essentially recapitulates the syllable structure of the language redundantly. That this is the right conclusion is reinforced by the fact that Chomsky and Halle had to complicate at least three other rules using the expression of (17)²--surely it would be better to provide general rules of syllabification for English, and allow the relevant rules to apply on the basis of syllable divisions. We see, then, that Prince and Selkirk's proposed introduction of the syllable into stress rules can be motivated independently.

Let us now examine the arguments for replacing the feature [+stress] with the foot. The first argument is simply

an application of Occam's razor: various research has shown that the foot is independently motivated because of the rules other than stress that must refer to it--for the case of English, see Kiparsky (1979); examples from other languages are presented later in this thesis. If we need feet anyway, and if they are adequate to represent stress, it is entirely reasonable to restrict (and thereby strengthen) phonological theory by eliminating the feature [+stress].

A second argument derives from a difficulty concerning the proposal about disjunctive ordering made in Chomsky and Halle (1968). Chomsky and Halle had proposed that the cases under which rules are ordered disjunctively are completely predictable: all and only those rules that are collapsible using parentheses are ordered disjunctively, with longer expansions automatically ordered before shorter ones. The disjunctive ordering convention produced admirable results in stress rules--for example, the Main Stress Rule of English could be reduced from three rules and three ordering statements, roughly as in (18):

- (18)a. $V \rightarrow [1 \text{ stress}] / \underline{\quad} C_0 \left[\begin{array}{c} V \\ -\text{tense} \end{array} \right] C_0^1 \left[\begin{array}{c} V \\ -\text{tense} \end{array} \right] C_0 \#$
- b. $V \rightarrow [1 \text{ stress}] / \underline{\quad} C_0 \left[\begin{array}{c} V \\ -\text{tense} \end{array} \right] C_0 \#$
- c. $V \rightarrow [1 \text{ stress}] / \underline{\quad} C_0 \#$

Conditions: a and b, b and c, a and c are ordered disjunctively.

to the far more compact formula of (19):

$$(19) \quad V \rightarrow [1 \text{ stress}] / \text{---} C_0 \left(\left(\left[\begin{array}{c} V \\ -\text{tense} \end{array} \right] C_0^1 \right) \left[\begin{array}{c} V \\ -\text{tense} \end{array} \right] \right) C_0 \#$$

(In both cases the complicating expression of (17) has been left out.) Such a large scale collapsing suggested that the disjunctive ordering convention had expressed a very important generalization about phonological rules. However, difficulties in the theory soon appeared: as investigation progressed, it became clear that the disjunctive ordering convention is necessary only for rules of accent, and that among other rules it often produces the wrong results (see for example Howard 1972, pp. 45-46). In addition, Kiparsky (1973) pointed out that there are many cases in which disjunctive ordering is needed but not predicted by the convention, in that the rules involved are not abbreviable with parentheses.

Metrical theory solves the dilemma of the disjunctive ordering convention by allowing us to eliminate it from phonological theory. Under a metrical approach, a stress pattern such as the English one is accounted for not by a group of rules, as the schema of (19) represents, but rather by a single rule, which determines the construction of a foot of variable size. Since there is only one rule, no questions of rule ordering arise. We can now see why the disjunctive ordering convention was necessary only for rules of accent assignment, since it is only accent rules that involve the construction of metrical trees.

One aspect of the formulation of (15) deserves immediate revision: the stipulation that the largest possible foot be constructed is not a peculiarity of English stress assignment, but appears to apply in virtually all stress rules. It makes sense, then, to abstract this condition out of the individual stress rules, formulating it as a universal convention:

(20) Maximal Tree Construction Principle

Metrical rules construct the largest tree compatible with their conditions.

I believe that a convention of this type was first posited in Prince (1976). Notice that the convention plays the same role in metrical theory as was played in disjunctive ordering theory by the principle that the longest rule of a set abbreviated by parentheses applies first. However, the two principles are not equivalent in their empirical predictions. As we shall see in the next chapter, there are reasons to prefer the Maximal Tree Construction Principle.

In their original article, Liberman and Prince (1977) claimed that a metrical theory that includes the feature [+stress] will also solve the problem of disjunctive ordering. They argued that once a given subrule of an abbreviated set of stress rules has applied, the structure created concomitantly would be sufficient to block the other subrules from applying, "under the minimal assumption that a given stretch of string can have only one set of metrical relations defined on it" (p. 283). However, in light of later research this argument

seems flawed. Kiparsky (1979) has shown that in the cyclic application of the English Stress Rule, the creation of metrical structure on a new cycle results in the deletion of whatever old structure existed in the domain of the new foot. This finding is relevant here, because in principle the shorter subrules of an abbreviated schema could induce the deletion of structure created by longer rules, as in (21):

<p>(21) $V \rightarrow [+stress] / \underline{\quad} C_0 \check{V} C_0^1 \check{V} C_0 \#$</p>	<p>labyrinth + - - s w w s V</p>
<p>$V \rightarrow [+stress] / \underline{\quad} C \check{V} C_0 \#$</p>	<p>labyrinth + + - s w V</p>
<p>$V \rightarrow [+stress] / \underline{\quad} C_0 \#$</p>	<p>labyrinth + + +</p>

It would seem then, that Liberman and Prince's analysis still requires the disjunctive ordering theory, with all its attendant problems. The foot based theory avoids these problems, since stress is assigned by a single rule rather than a conflated set of rules.

Another argument for the revised theory stems from a different aspect of rule locality. Most phonologists would share the intuition that phonological rules normally apply to the closest relevant segment to the conditioning environment, where "relevant" means roughly speaking that the segment fits

the internal requirements for segments that can undergo the rule--for discussion see Howard (1972). For example, rules of the type (22)a. would be considered highly natural, while rules resembling those of (22)b. would be considered bizarre:

$$\begin{aligned}
 (22)a. \quad V &\rightarrow [+nasal] / \text{---} \left[\begin{array}{c} C \\ [+nas] \end{array} \right] \\
 & \\
 V &\rightarrow [+round] / \left[\begin{array}{c} V \\ [+round] \end{array} \right] C_o \text{---} \\
 & \\
 b. \quad V &\rightarrow [+nasal] / \text{---} C_o \left(\left(\left[\begin{array}{c} V \\ [-tense] \end{array} \right] C_o^1 \right) \left[\begin{array}{c} V \\ [-tense] \end{array} \right] \right) \left[\begin{array}{c} C \\ [+nas] \end{array} \right] \\
 & \\
 V &\rightarrow [+round] / \left[\begin{array}{c} V \\ [+round] \end{array} \right] C_o V C_o \text{---}
 \end{aligned}$$

There are two exceptions to this pattern. One is the type of rule which affects a whole string of relevant segments, as in many vowel harmony rules. This has been regarded as an illusory exception, since it can always be handled using a local rule which applies iteratively to its own output. The second kind of exception is found in rules of accent: notice that segmental stress rules like (23):

$$\begin{aligned}
 (23)a. \quad V &\rightarrow [+stress] / \text{---} C_o \left(\left(\left[\begin{array}{c} V \\ [-tense] \end{array} \right] C_o^1 \right) \left[\begin{array}{c} V \\ [-tense] \end{array} \right] \right) C_o^\# \\
 & \\
 b. \quad V &\rightarrow [+stress] / \left[\begin{array}{c} V \\ [+stress] \end{array} \right] C_o V C_o \text{---}
 \end{aligned}$$

are far more natural than the formally very similar non-accent rules of (22). Because of this, Howard (1972), in formulating

a principle of local rule application, explicitly excluded rules of accent, although he could provide no explanation for this bifurcation of phonological rules. If accent assignment is actually foot construction, we have an explanation: a metrical stress rule determines the relative prominence of all the syllables in its domain of application, rather than assigning a feature value to a single segment-- the stressless syllables of the foot are affected by the rule just as much as the stressed one, in that they are marked as relatively weak. A foot construction rule therefore does not skip over relevant segments; it simply applies to a string that is somewhat larger than what is found in most phonological rules. Because of this, foot construction may be said to be local in the same sense that segmental rules are.

I am not prepared to provide a formal definition of rule locality here. The matter has caused a great deal of theoretical controversy (see Howard 1972, Johnson 1972, Jensen 1974, Odden 1977). I suspect that the rather legalistic verbal locality constraints advocated by these researchers will eventually prove inadequate, and that the proper formulation of locality will be more formal in nature, involving enrichments of phonological representations such as the use of projections, proposed in Vergnaud (1977) and discussed below. It seems clear, though, that under any reasonable treatment of rule locality, the metrical approach provides a motivation for the apparent non-local application of accent rules.

It isn't obvious to me to what extent the foregoing is

an argument for a metrical theory lacking the feature [+stress] or just an argument for metrical theory in general. Liberman and Prince's theory does seem to violate locality insofar as it contains rules of the type (24):

$$(24) \quad V \rightarrow [+stress] / \text{---} C_0 ((\check{V}C_0^1) \check{V}C_0)\#$$

But one might argue that the concomitant creation of metrical structure makes the rule local. The foot based theory, which involves no rule of the type (24), does have the advantage of resolving all doubts on this score.

4. The Theory of Syllable Weight

Many stress rules, such as the stress rule of English, draw a distinction between light syllables, having the form $C_0\check{V}$, and heavy syllables, which include $C_0\bar{V}$, C_0VC , and anything heavier. This has always been a problem for phonological theory: the distinction is very common, but it can't be expressed using a phonological feature, barring the use of some ad hoc cover feature such as [+heavy]. Even expressed without a cover feature, the heavy-light distinction seems an arbitrary one under standard theories, since the notion of heavy syllable must be expressed as a disjunction, i.e. as in (25):

$$(25) \quad C_0 \left\{ \begin{array}{l} \bar{V} \\ VC \end{array} \right\} C_0$$

Recently, McCarthy (1979a,b) and Vergnaud and Halle (1978) have proposed a solution to the problem. The first ingredient of the solution is to posit an internal structure for syllables. This idea did not originate with generative phonology (see, for example Pike and Pike 1947, Fudge 1969), but its utility in formulating phonological rules has only recently been fully realized. It seems likely that syllables are universally divided into an onset, consisting of the segments preceding the syllabic prominence peak of the syllable (if any), and a rime, consisting of everything else.³ Some arguments for the existence of the rime constituent are the following: (1) Generally, cooccurrence restrictions on the segments of a syllable are more stringent between vowels and following consonants than between vowels and preceding consonants, which suggests that such restrictions apply primarily within the rime; (2) Accent rules are almost always sensitive only to the number of segments in the rime, not in the onset; (3) It is probable that in tone languages, sonorant consonants may bear tone only if they occur within the rime, not the onset (see Halle and Kiparsky 1979); (4) Quantitative rules of versification always count segments in the rime, ignoring the segments in the onset. Arguments for the existence of the onset are rarer, but the following may be cited: (1) The onset is moved as a unit in spoonerisms and language games such as Pig Latin; (2) The onset is referred to in alliterative rules of versification.

It is far more difficult to motivate lower level

constituents within the syllable, but this will not be especially important here. The crucial observation that McCarthy, Vergnaud, and Halle made is that the existence of a rime node offers a simple way of distinguishing light and heavy syllables: if long vowels are represented as underlying geminate, the distinction is one of branching versus non-branching rimes:

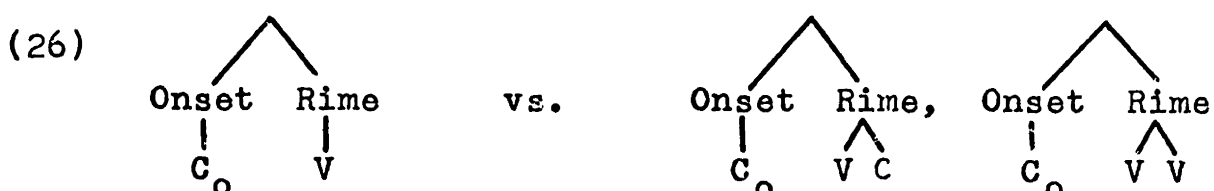

From this geometrical viewpoint, the grouping together of $C_0\bar{V}$ and C_0VC syllables is no longer a disjunction.

The criterion of branching is in fact especially appropriate to stress rules. As we have seen, both word trees and compounds in English are labeled by rules that are sensitive to branching, so that it is entirely reasonable to suppose that the distinction of branching is relevant to the construction of metrical feet. But if the rules form trees out of syllables, how can they be made sensitive to the branching of constituents that are syllable internal? A good way to accomplish this has been proposed by Morris Halle: we specify that the stress rules apply on a special representation consisting solely of the rimes of the phonological string, to be called the rime projection. The rime projection is not to be regarded in any sense as derived from normal representation, but is simply a simultaneous representation available

for the application of phonological rules--the results of rules that apply on the rime projection are automatically carried over into the full representation, and vice versa. The utility of such a representation outside the domain of accent rules should be immediately apparent: for example, we can simplify rules assigning tone to sonorants, rules of quantitative versification, and rules affecting vowels before tautosyllabic consonants simply by specifying that they apply on the rime projection.

Let us now examine a well known stress rule and see how it might be interpreted under the geometric distinction of branching versus non-branching rimes. In Latin, stress is placed on the antepenultimate syllable of a word having three or more syllables with a light penult. In other cases, stress falls on the penult. This can be expressed in metrical terms as follows:

- (27) On the rime projection, form a foot at the right edge of the word, such that
- a. The foot contains at most three terminal nodes.
 - b. The middle node, if there is one, is non-branching.
 - c. Sister nodes are labeled s w.

Then incorporate all structures into a right branching word tree, in which sister nodes are labeled w s.⁴

We will illustrate this rule with the stressings of the words pepér̄cī, inimícus, confíciunt, ténebrae, and tóga. Syllabified according to the rules of Latin, these appear as in (28):

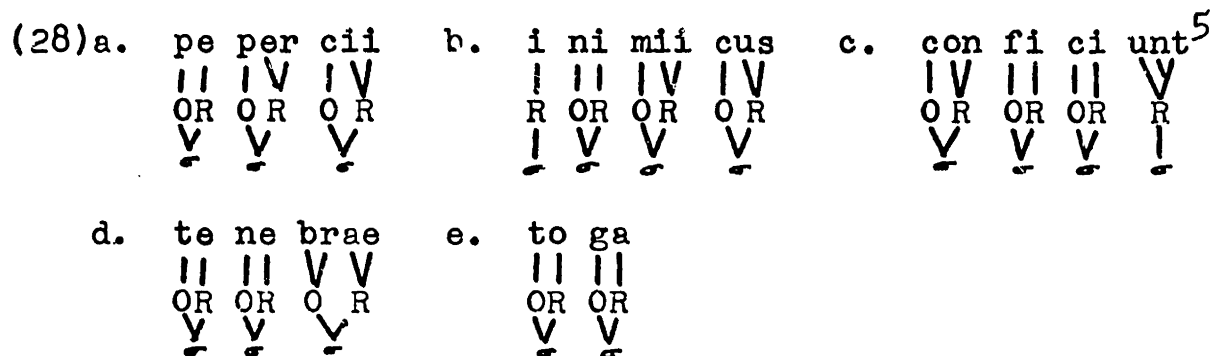

where long vowels have been represented as geminate. The syllabifications of (28) can be motivated independently by the facts of Latin versification; see Allen (1973). The rime projections of (28) are as follows:

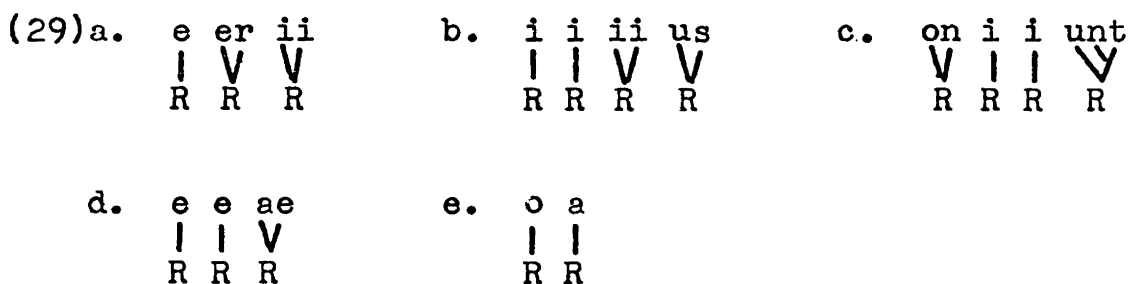

Applying the rules of (27), we come up with the following structures:

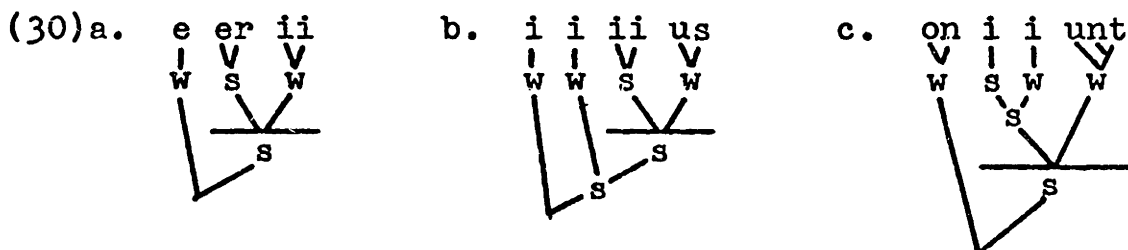

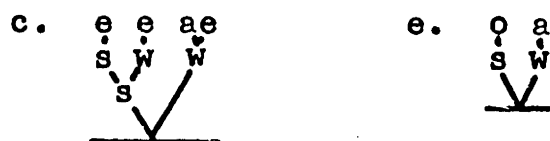

Notice that in each case, the largest foot compatible with the conditions of (27) has been formed, in accordance with the Maximal Foot Construction Principle. To translate the representations of (30) back into the full phonological representation, we simply assume that onsets form part of the same metrical constituent as their sister rimes:

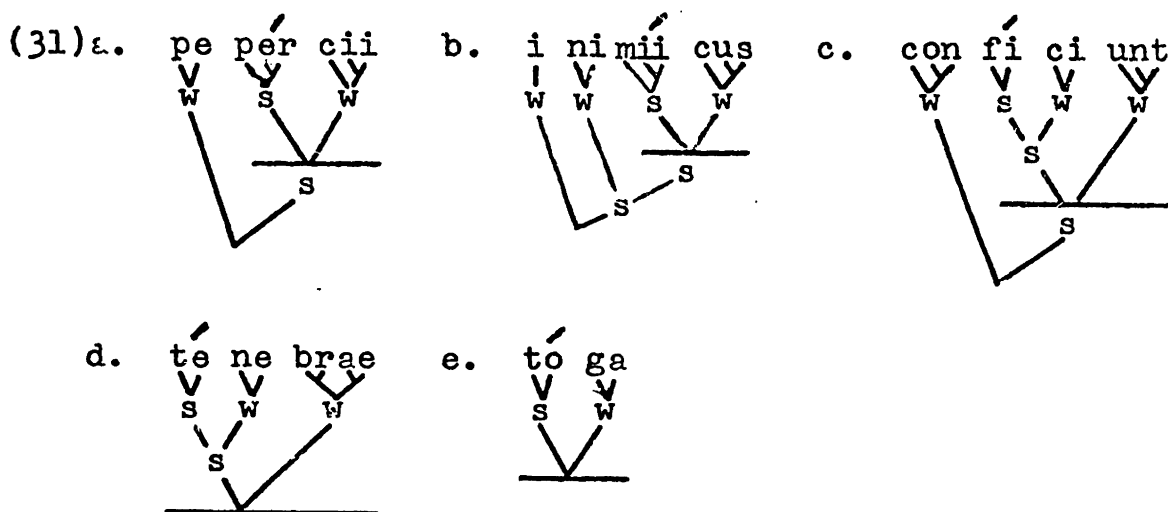

It is crucial that metrical structure be carried over into the full representation, since some rules that affect onsets may refer to metrical structure (see Kiparsky 1979).

I have recorded the position of the main stress in (31) with accent marks, a practice I will follow in surface representation throughout this dissertation. It is important to realize that these are not part of the phonological representation--they are simply intended to make the trees easier to read.

It is useful to reflect on the remarkable formal simplicity of a rule like (27): it contains no variables such as C_0 or parentheses; and it doesn't refer to any phonological features or even segments. The rime constituents it brackets together appear to be independently necessary in phonology, as is the device of rime projection. Surely the geometrical approach is close to the bare minimum to which we could hope to reduce a stress rule.

Halle's idea also has very important implications for the construction of a universal theory of stress rules. Suppose for the moment that all distinctions of syllable prominence can be expressed as the distinction of a branching versus a non-branching node. (We will show later that this is for the most part true.) We might then be able to express all stress rules geometrically: the set of tree construction rules would then be basically coextensive with the set of maximal tree shapes.

In Hyman (1977, p. 37), it claimed that we have no answer to the question of what is a natural stress rule. I believe that this is overly pessimistic, and derives from Hyman's approach of simply generalizing about where stress normally appears on the surface in various languages. It is far more productive, I believe, to see what the stress rules look like in a well articulated theory. The metrical theory of stress is especially appropriate to such an investigation, since it compartmentalizes the problem into a number of separate issues. In particular, we can look at (1) possible tree geometries;

(2) possible procedures for labeling metrical structure;
 (3) the number of separate levels of metrical structure needed;
 (4) the direction in which feet are constructed by iterative rules; and various other possible "ingredients" of stress rules, examining in each case whether a theory can be constructed designating certain geometries, labelings, etc. as unmarked.

This is essentially the investigation I have undertaken here. My results can be summarized as follows: (1) A sharply restricted theory of tree geometry appears to be adequate to account for the great majority of the stress rules of the world; (2) The range of possible labeling rules is broader than the range of possible tree geometries, but certain labeling rules are clearly unmarked; (3) In the remaining areas, such as the number of levels and directionality of application, it is either impossible or premature to arrive at any conclusions about markedness. The thesis as a whole, I hope, brings us closer to understanding what constitutes an unmarked stress rule.

5. Outline and Miscellanea

I have laid out the remaining four chapters of this thesis in the following way. Chapter 2 contains a fairly detailed analysis using metrical theory of stress in Aklan, a Philippine language. I have placed it first because it constitutes a good argument in favor of metrical theory over segmental approaches, and because it should help familiarize the uninitiated reader with metrical derivations in

preparation for the proposals that follow. Chapter 3 constitutes the heart of the thesis, presenting and justifying a theory of unmarked tree geometry. Chapter 4 addresses the less involved problem of unmarked tree labelings. In the final chapter the theory is applied to the English stress system: we will find that the numerous apparent counter-examples to the theory in English turn out on closer examination to confirm it.

Before proceeding I must mention three topics that are somewhat peripheral to the main concerns of the thesis. The first is the difficult question of how stress is phonetically realized. It is apparent from phonetics research that the cues for stress are numerous and variable, including pitch, duration, intensity, and other factors. Lehiste (1970) suggests that at least for certain secondary stresses, there are no phonetic cues for stress at all, and that native speakers perceive stress according to what the phonological rules of their language predict in the more perspicuous environments. If the reader wonders, then, just what phonetic reality the trees in this thesis represent, the answer is essentially none: the trees depict a mental representation of the relative prominence of syllables and words in an utterance. This fairly high level representation is usually realized phonetically by the rules governing pitch, intensity, and duration which refer to it. In English, there are other rules which are sensitive to metrical structure and thus shed light on it: vowel reduction and certain other segmental rules depend

on foot structure, and the intonational system is tightly bound up with stress. It is significant that the phonetic means of realizing stress vary from language to language: some but not all languages lengthen vowels under stress, raise the pitch of stressed syllables, and so on. The point is that an abstract, mentalistic representation for stress is the only type that is workable. Given the great variability and inconsistency in the cues for stress, any attempt to predict these cues directly by rule would lead to chaos.

The other principal gap in this dissertation concerns the distinction between so called stress accent and pitch accent languages. I assume tentatively that the latter contain rules that interrelate a metrical representation to a tonal representation of the autosegmental type proposed by Goldsmith (1976), although it is quite conceivable that the tonal representations themselves are metrical in nature. This question must be left for future research.

One question for which I will assert an answer is that of the level of the derivation at which the rules of syllabification apply. This is an important question for metrical theory, since it is often the structures governing syllabification that determine stress placement. I will follow McCarthy (1979a) in claiming that in the unmarked case, segments are properly syllabified in underlying representations, with resyllabification occurring automatically where needed throughout the phonological derivation. Rules are ordinarily blocked when their outputs cannot be properly syllabified.

Exceptions to this pattern are possible, though only at the cost of some markedness--for example, we must sometimes postulate underlying syllabifications that violate canonical patterns, as for example in Hebrew CVCC syllables (Prince 1975, McCarthy 1979a). In addition, fast speech rules typically violate canonical syllable patterns, as in English [seyŋ] for saying and [pt^heyDow] for potato. The consequences of this assumption will be made clear at various points in the dissertation.

Footnotes to Chapter 1

¹In addition, the environment /____s $\begin{bmatrix} -\text{son} \\ -\text{cont} \end{bmatrix} \left(\begin{bmatrix} \text{acons} \\ \text{avoc} \end{bmatrix} \right) \text{V}$ is required at least some of the time--see discussion in Chapter Five.

²The rules are (as numbered in Chapter Five, pp. 239-245) Auxiliary Reduction II (24), Pre-Cluster Laxing (20.III), u Tensing (23.III), and Tensing before CiV (23.IV). In addition, Auxiliary Reduction I (20.I) can be shown to require a similar modification, although Chomsky and Halle do not point this out.

³In some cases, there is evidence that glides preceding the nuclear vowel belong to the rime. These cases still adhere to the ordinary pattern to the extent that the sonority peak of the syllable belongs to the rime, not the onset.

⁴We will later have reason to revise this rule, which is presented in the form of (27) for expository purposes.

⁵I have assumed arbitrarily that Latin rimes have a right branching internal structure. Nothing in the analysis depends on this.

Chapter 2: Stress in Aklan

1. Preliminaries

Aklan is a Philippine language spoken on the island of Panay. Its stress pattern is of interest because of the light it throws on the question of whether stress rules are formulated segmentally or based on foot geometry, as suggested in the preceding chapter. My source of data on Aklan is Chai's (1971) doctoral dissertation, a work which is primarily devoted to Aklan morphology, and deals with Aklan phonology only briefly. However, since Chai was so thorough as to record primary and secondary stresses on virtually every example, there are plenty of data on which to base an analysis.

The syllable structure of Aklan is quite simple: only CV and CVC are permitted, aside from certain loan words, and there is no distinction of vowel length. All Aklan roots have at least two syllables, with the exceptions again occurring only in loan words.

Before proceeding with the analysis, I must remark on the data that it is intended to describe. The transcription used is straightforward except for /g/, which represents a voiced velar fricative. However, the stress data require a certain amount of interpretation: Chai's transcriptions generally do not show as many stressed syllables as my analysis predicts to exist. For example, Aklan words having penultimate main stress and a light second syllable, such as nag-daḡagan "run-actor focus-past" or mag-m-aḡ-aḡhud "more than two

siblings," are predicted by my analysis to have three stresses, ranked in this order:

(1) 2 1 3 2 1 3
 nag-dagágan mag-m-ag-áḡhud

However, Chai's transcriptions usually record only the strongest two of these: nàg-dagágan, màg-m-ag-áḡhud. Only sporadically does the second weak stress appear, as in nàg-h-iḡ-úhà? "go trying to take-actor-past", nàg-hi-tú?ùn² "become matched-actor past." Similarly, my predicted ma-nug-^{3 1} ?aradu "expected to plow" and na ^{2 3 1} ?a-atubaḡ "face-actor-present" show up as ma-nùg-?aradú, na-gà-?atubáḡ, but na-ga-^{3 1} pa-n-abun "go soaping-actor-pres." shows up as na-gà-pà-n-abún.

In general, I will take my analysis to be correct if the primary stress it assigns coincides with that of Chai's transcriptions, and if Chai's secondary stress markings coincide with the predicted weak stresses, taken in descending order. Thus na-ga-?atubaḡ = na-gà-?atubáḡ^{2 3 1} would be regarded as a correct prediction, but na-ga-?atubaḡ = na-ga-?atubáḡ¹ would not be. This procedure has some plausibility: if the analysis is correct, Aklan is a language that is very rich in stressed syllables. It is only natural that an economical transcription would record only the strongest among them.

2. Analysis

With this in mind let us turn to the facts of Aklan stress. Main stress always falls on one of the last two syllables of the word, determined in large part by arbitrary lexical categorization of the root. We thus find roots that

are distinguished solely by stress:

(2)	pitú	"seven"
	pítu	"whistle"
	sugúd	"room"
	súgud	"lice comb"

When suffixes are added to a root, the stress shifts, so that the new word usually has the same stress pattern as its derivational source: penult-stressed roots have penult-stressed derivatives and final stressed roots have final stressed derivatives, as in (3):

(3)a.	híkut	"cook"
	hikút-an	"cook-referent focus-future"
	sípa?	"kick"
	sipá?-a	"kick-goal focus imperative"
b.	butáj	"place"
	butaj-án	"place-ref.-fut."
	bisá	"kiss"
	bisa-hí	"kiss-ref.-imp."

A few affixes which exhibit different behavior will be discussed below.

The data presented so far could be analyzed in a very simple way: we could suppose that Aklan has two main stress rules, assigning either penultimate or final stress, depending on a diacritic marking attached to the root of the word. Other facts, however, show that matters cannot be this simple.

To see this, note that words which have a closed penultimate syllable always bear penultimate stress. This in itself could be handled by a lexical redundancy rule stating that closed-penult roots are marked so as to trigger the penultimate stress rule. However, the evidence from suffixation contradicts this: it turns out that when suffixes are added to closed-penult roots, the resulting derivatives fall into the ordinary two categories of penultimate and final stress, as in (4):

- | | | |
|-------|---------------|-----------------------------|
| (4)a. | bítbit | "carry" |
| | bitbit-a | "carry-goal-imp." |
| | hámbaǵ | "speak" |
| | h-aǵ-ambáǵ-un | "that which should be said" |
| b. | ǵásta | "spend" |
| | ǵasta-hún | "spend-goal-fut." |
| | ?asirtar | "lucky" |
| | ?asirta-hí | "lucky-ref.-imp." |

We can infer from this that the closed-penult roots, just like other roots, freely bear either diacritic marking for which stress pattern they take; but that when they occur alone, a more general requirement that closed-penult words must have penultimate stress overrides the lexical marking. Thus it cannot be a lexical redundancy rule that accounts for the stress on bítbit, ǵásta, etc.

A different argument can be made to the same effect. Many words in Aklan drop their last vowel when a suffix

follows, subject to the limitation that no triple consonant cluster be created, since such a cluster cannot be syllabified according to the canonical Aklan pattern. Typical examples of this process are as in (5):

- | | | |
|-------|---------------------|-------------------|
| (5)a. | puyúŋ | "tie" |
| | púyŋ-un | "tie-goal-fut." |
| b. | pa-ligús | "bathe" |
| | g-in-pa-lígs-
an | "bathe-ref.-past" |

The rule is lexically governed, as can be seen by comparing the examples of (5) with those of (3). The point to be made here is that although the root words of (5) must be marked diacritically for final stress, stress is penultimate in their derivatives because of their closed penultimate syllables. We conclude again that penultimate stress must be assigned in these cases by a phonological rule.

The analysis to be presented here will account for this stress placement, but cannot be presented until we have examined the facts of secondary stress placement in Aklan. These are as follows:

(a) Chai always records secondary stress on the last syllable of words that have three syllables with penultimate main stress:

- | | | |
|-----|------------|---------------|
| (6) | balíbad | "refuse" |
| | libákaw | (place name) |
| | h-ag-ámpaŋ | "play-plural" |

ka-sákay

"ride together"

(b) In a few of Chai's transcriptions, such as nàg-hi-ŋ-úhà?, nàg-hi-tú?ùn, mentioned above, or píniŋ (proper name), secondary stress is also noted on the final syllable of a penult-stressed word having other than three syllables.

(c) The stresses lying to the left of the main stress can be described using a distinction between short and long syllables. The long syllables are the closed syllables, plus two open syllabled prefixes: ka-, a widespread nominal prefix, and ga-, a verbal prefix having progressive meaning. All other syllables are to be considered short. We use the terms "short" and "long" here rather than "light" and "heavy", because ka- and ga- are strictly speaking light syllables. The secondary stress can be described as follows: it is assigned recursively to the syllable immediately preceding a stress if that syllable is long, and two syllables to the left of a stress if the syllable immediately preceding the stress is short. This is illustrated by the following examples:

- (7)a. ma-sìg-hímus "will each tidy up"
piligrúsu "dangerous"
h-ag-àmbág-un "that which should be said"
- b. na-gà-hádluk "frighten-actor-pres."
kà-hilúŋ-un "state of drunkenness"
k-in-à-putús "wrap-instrument focus-past posterior"
g-in-à-púst-an¹ "wrap-ref.-pres."

c.	mà-pa-ŋ-ísda?	"go fishing-actor-fut."
	s-ug-ùgu?-ún	"servant"
	?atubaŋ-án	"genitals"
	màg-m-ag-áŋhud	"more than two siblings"

Notice that in k-in-à-putús and g-in-à-púst-an, the heavy prefixes ka- and ga- attract stress despite being split by an infix. In general, if a word contains two syllables that under the provisions of (c) should receive secondary stress, only the one on the left is marked as stressed by Chai:

(8)	na-gà-pa-maníla?	"go to Manila-actor-pres."
	kà-gasta-hún-an	"expenditures"
	nàg-ka-sákay	"become co-passengers-actor-past"

My suspicion, however, is that both syllables should be regarded as having some degree of stress, at least at some stage of the phonological derivation. There are two reasons for this: first, the second stress often does show up in the transcriptions, as in (9):

(9)	na-gà-pà-n-abún	"go soaping-actor-pres."
	p-in-a-kà-ma-bákas	"fastest"
	nàg-k-in-à-lisúd	"worry-actor-past"

In addition, the algorithm of (c) works only if it can use the hypothetically stressed syllables as starting points in the counting off of short and long syllables: for example, in mà-?ug-ugtás-un "fussy" the count must start at the

hypothetically stressed syllable gug in order to come out right, while the initial stress on mà-t-in-amar-ún "being lazy" will be placed properly only if we assume that stress is placed on the third syllable of the word as well.

I will now show how a fairly simple metrical analysis can account for all of the above observations. For the moment discussion will be confined to words having final main stress. These words need appear with no special marking in the lexicon; the stress rules alone as formulated below can account for them. The first rule that is needed is one that constructs the metrical feet:

(10) Foot Construction

Going from right to left on the rime projection, assign feet containing at most two rimes, labeled *w s*, such that

- a. weak nodes do not branch.
- b. weak nodes do not dominate the rimes of the prefixes ka- and ga-.

It is clear that (10) will place a stress on the word final syllable, and will then place further stresses across the word, skipping over short syllables if they immediately precede another stress. The process is illustrated below in the derivation of na-gà-pà-n-abún. The rime projection of the word is as follows:

Rule (15) constructs the following tree for na-ga-pa-n-abun:

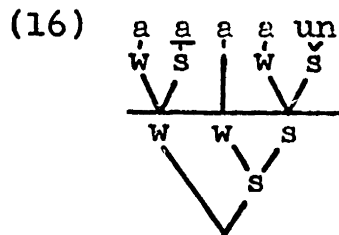

Translated back into the full representation, it appears as follows:

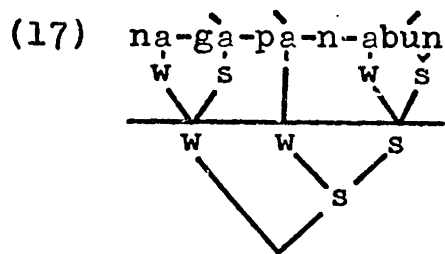

Since the final foot of the word tree is branching, it is labeled *s*, as is the node that dominates it. Thus the strong syllable of the final foot, bun, receives main stress, as it is dominated exclusively by *s*'s. The syllables ga and pa, being either the strongest or the only elements of their feet, receive secondary stress. Note that under the ordinary interpretation of trees as assigning greater stress to weak feet that are less deeply embedded in the tree, we would expect the stress on ga to be stronger than the one on pa. This is borne out by the stressing that Chai assigns to words of parallel structure, such as na-ga-?atubán "face-actor-pres.," in which the weak stress we would expect to find on the syllable corresponding to pa has been omitted in Chai's transcription.

The rules (10) and (15) assign the correct stressing (within the limits of the transcription) to all the words presented so far having final main stress. To clarify the metrical structure, I have drawn in only rime internal structure within the syllable:

(18)a. pitú (similarly sugú, bisá)

b. bisa-hi (similarly gasta-hún)

c. s-ug-ugu?-ún (similarly ?atùbaḡ-án, k-in-à-putús)

d. nag-k-in-à-lisú

e. mà-t-in-amar-ún

Consider now what happens when the rules apply to a word having a closed penult, as in gásta, ?asírtàr. The first foot to be assigned in this case must be monosyllabic, since

if it were branching its weak node would dominate a branching rime:



The remaining foot and the word tree are then constructed:

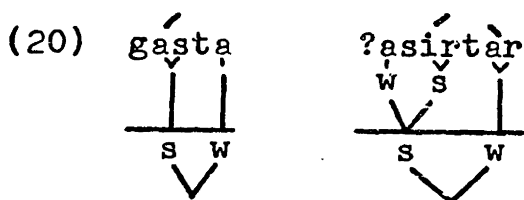

Since the final foot does not branch, it is labeled as weak, and the greatest prominence is assigned to the preceding foot. Thus the assignment of primary stress to closed penults is an automatic consequence of the rules and structures independently needed to account for stress assignment in other contexts. Note that the secondary stress on the final syllable of ?asirtar is also correctly predicted. The analysis does predict secondary stress on the last syllable of gasta, and in fact on the last syllable of all Aklan words with penultimate primary stress. As I have mentioned before, this final secondary stress shows up sporadically in Chai's transcriptions. It is usually omitted where there is a stronger secondary stress and in bisyllables.

The words not yet dealt with--those that have root governed penultimate stress--present two problems: how to mark them in the lexicon so that main stress will reside on the penultimate syllable, and how to capture the principle

that the stressing of derived words follows the stressing of their roots. The first problem can be solved by requiring that these words undergo the rules presented so far with a non-branching foot already resting on their final rimes, as in (21):

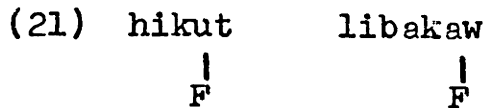

The foot construction rule (10) then applies to the remaining rimes of the word, organizing them into feet:



The penultimate stress is then accounted for by the word tree rule, which will mark the penultimate foot as strong, since its partner on the right doesn't branch:

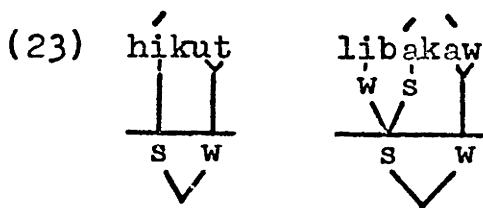

Once again, the predicted secondary stress accords quite generally with Chai's transcriptions in three syllable words, and with sporadic transcriptions in the two syllable words.

There are a number of ways to insure that derived words in Aklan copy the stress pattern of their roots. I will assume here that the relevant roots in Aklan are marked with a diacritic feature [+Penult Stress], abbreviated [+PS],

which percolates to all the segments of the word, along the lines of the proposal in Chomsky and Halle (1968, pp. 377-378). The feature value [+PS] is implemented in the phonology by the following rule of foot construction:

$$(24) \quad \begin{array}{c} R \\ [+PS] \end{array} \longrightarrow \begin{array}{c} R / \text{---} \# \\ | \\ F \end{array}$$

that is, form a non-branching foot over a rime marked [+PS] when it is word final. For example, the root hikut is marked in the lexicon as [+PS]. This feature marking percolates to the segments of the suffix in the derived form hikut-an. Both forms receive a non-branching foot by rule (24):

$$(25) \quad \begin{array}{cc} \text{hikut} & \text{hikut-an} \\ \text{---} | & \text{---} | \end{array}$$

Penultimate main stress then follows from the derivation illustrated in (21)-(23).

Armed with these rules, we can correctly provide the stresses for the examples presented earlier. In all of the cases presented below, the root is marked [+PS], resulting in a monosyllabic foot being created word finally.

$$(26)a. \quad \begin{array}{c} \text{hambag} \\ \text{---} | \end{array} \longrightarrow \begin{array}{c} \text{hambag} \\ \text{---} | \quad | \\ \text{S} \quad \text{W} \\ \text{---} \end{array}$$

b. h-ag-ambag-un → h-ag-ambag-un similarly
 ma-sig-himus,
 pilgrusu

c. h-ag-ambag-an-un → h-ag-ambag-an-un

d. nag-ka-sakay → nag-ka-sakay

e. ma-?-ug-ugtas-un → ma-?-ug-ugtas-un

f. p-in-a-ka-ma-bakas → p-in-a-ka-ma-bakas

Of particular interest among the above examples are those of (26)b., in which a long syllable induces a blatantly clashing stress pattern.

Our analysis provides a solution to the problem of allowing all roots to be marked for penultimate or final stress while still assigning penultimate stress to all closed penult roots in isolation. For example, the root hámbag, with penult stressed derivatives (h-ag-`ambáǵ-un), is assigned the same stress pattern as gásta, with final stressed derivatives (ǵasta-hún):

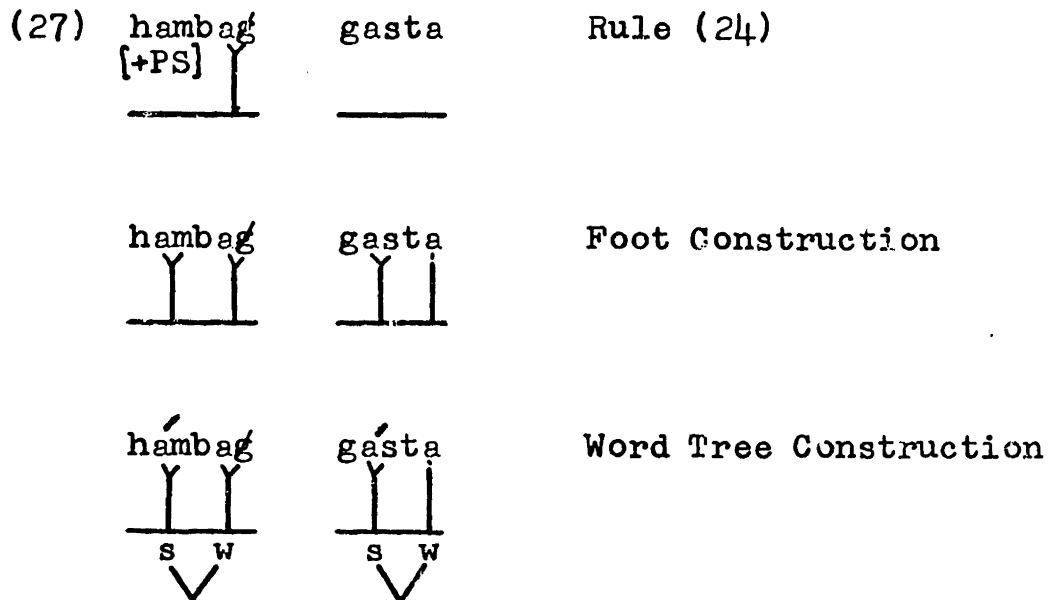

despite the difference in their underlying representations. In either case, the heavy penultimate syllable will not be incorporated into the following foot, owing to the conditions on foot formation.

There is one class of words that is stressed incorrectly under the analysis as presented thus far--words having three syllables, with penultimate main stress and a long initial syllable:

(28) ka-báǵay "housemate"

nag-ka ^ˈ ?un	"eat-actor-past"
mag-má ^ˈ ŋhùd	"two mutual siblings"

These words have final secondary stress, even though the analysis predicts that the strongest weak stress will be initial:

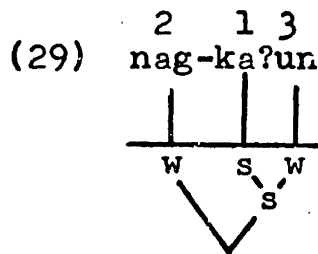

To correct this we must formulate another rule to destress the initial syllables of these words. Under a metrical theory, destressing rules are formulated as rules deleting feet, or more precisely, removing the hierarchical organization that dominates the rimes. We will express destressing rules here as rules which remove the label F, with any conditions on the material the foot dominates indicated by placing the relevant material below the focus bar. Using this notation, Aklan destressing may be expressed as follows:

(30) Destressing

$$F \rightarrow \emptyset / \# \begin{array}{c} \text{T} \\ | \\ \sigma \end{array} \begin{array}{c} / \\ \sigma \end{array}$$

where σ represents a syllable. The effect of (30) is to remove a non-branching foot on an initial syllable whenever the following syllable is metrically strong. It applies to

nag-ka?un as follows:

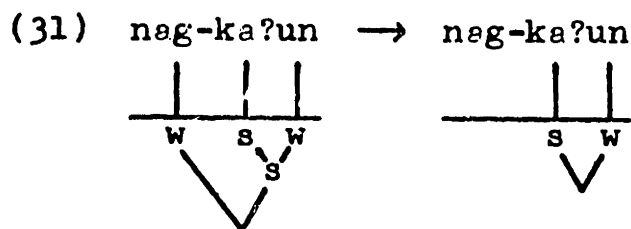

By a convention we will develop later, the unattached syllable in (31) is adjoined as a weak member of the following foot:

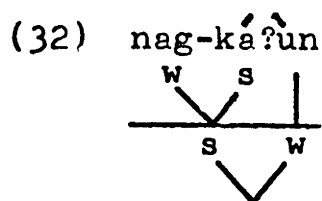

resulting in the same stress pattern as words with short initial syllables, such as hikút-àn, ?asírtàr.

I have mentioned above that certain suffixes in Aklan form words that have their own stress pattern, rather than mimicking the stress of the root. An example of this is the "substantival" suffix -an, which is used to form nouns and adjectives. Substantival -an invariably induces penultimate stress, as shown here:

- (33)a. ?awat-ú'n "bother-goal-fut."
 kà-?awat-ú'n-an "chores"
- b. ?ibá "companion"
 ?ibá-hà'n² "companions"
- c. dálit "toxin"
 dalít-à'n "toxic"

The metrical theory offers a very simple explanation for this: we need assume only that substantival -an is itself marked with the diacritic [+PS] so that rule (24) will always assign it a non-branching foot. The derived forms of (33) will thus have a final non-branching foot early in their stress derivations, and will receive penultimate stress by the regular application of the rules.

Another suffix, also taking the phonetic form -an, marks the instrumental voice in the imperative. It displays a pattern opposite to that of substantival -an, always having final main stress.

(34)	súka	súka-hán	"vomit"
	tápuk	tápuk-án	"dispose"
	tahág	tahág-án	"sharpen"

We assume here that words ending in this suffix are marked as exceptions to rule (24), so that they will not receive word final monosyllabic feet. They will accordingly receive final stress, as in (35):

(35) tapuk-an
[+PS]

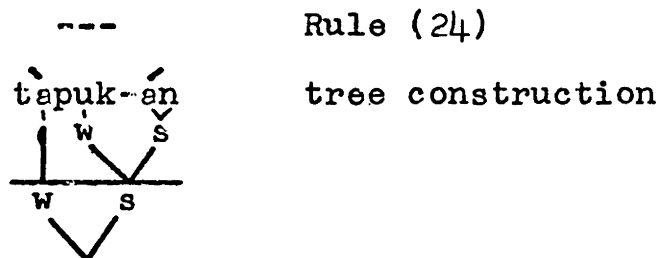

The only exception to this pattern is in words that have

closed penults, which may arise through the effects of the vowel dropping rule. These receive penultimate stress, as the rules would predict: púst-an "wrap-inst.-imp."

Aklan apparently relies on stress to help disambiguate three otherwise homophonous suffixes: substantival -an induces penultimate stress, instrumental -an induces final stress, and the remaining -an, which marks the referent voice in all verbal forms but the imperative, is regular.

Aklan is rich in reduplicated forms, many of which are stressed irregularly (as is often the case with reduplication). Although I lack the data to account for most of these, the following example will show how the necessary morphological stress rules can be fitted into the larger pattern. Typically when a prefix is reduplicated in Aklan, it receives a secondary stress which dominates over syllables that one would expect under the analysis to have stronger stresses. Thus we have

- (36) nag-kà-ka-sákay "become co-passengers-actor-past"
 nag-pà-pa-maníla? "cause to go to Manila-actor-past"
 nag-pà-pa-líguŝ "cause to go take a bath-actor-past"

versus the expected

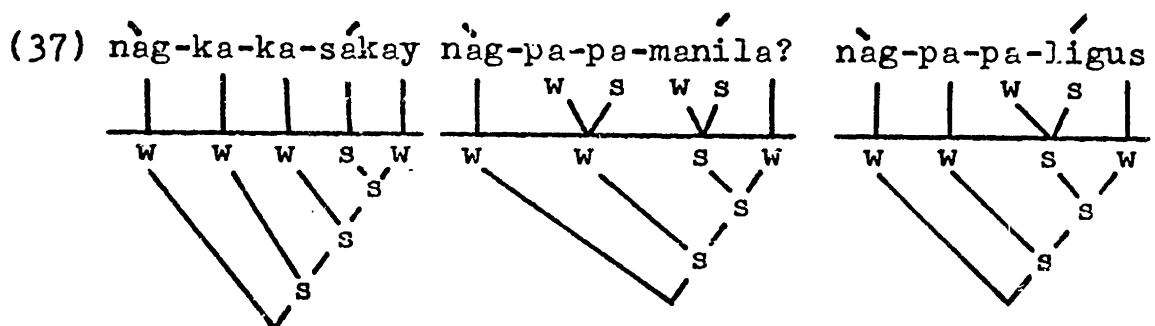

One explanation for this would be that reduplicated prefixes are accompanied by an exceptional metrical foot, labeled *s w*, to be assigned by the following rule:

$$(38) \quad [CV]_{\text{prefix}_a} [CV]_{\text{prefix}_b} \rightarrow \begin{array}{c} [CV]_{\text{pre}} \quad [CV]_{\text{pre}} \\ \swarrow \quad \searrow \\ s \quad w \end{array}$$

Condition: $a = b$

This foot would figure in the derivation of nag-ka-ka-sakay, for example, as follows:

$$(39) \quad \text{nag-ka-ka-sakay} \rightarrow \text{nag-ka-ka-sakay} \rightarrow \text{nag-ka-ka-sakay}$$

The Destressing rule (30) would then remove the non-branching foot on nag, since it immediately precedes a metrically strong syllable:

$$(40) \quad \text{nag-ka-ka-sakay} \rightarrow \text{nag-ka-ka-sakay}$$

Similar derivations would occur for nag-pa-pa-manila? and nag-pa-pa-ligus.

3. Theoretical Consequences

The theoretical importance of the analysis presented here

lies in its superiority over a segmental account of the same facts. Let us review the principal phenomena which any analysis must account for: these are (a) the assignment of main stress to one of the last two syllables of the word, as determined by the root; (b) the consistent assignment of penultimate main stress to words with closed penults; (c) the placement of secondary stress on the final syllable in words with penultimate main stress; (d) the recursive assignment of secondary stress to the left of a stress by the algorithm of p. 41; (e) the relative prominence of the secondary stresses as measured by ^{the}regularity with which they show up in Chai's transcriptions. I will present here the best segmental analysis of these facts I can think of. Obviously, the strength of the argument depends on comparing my analysis with the best available straw man.

The effect of rule (24), which assigns a final monosyllabic foot to words marked [+PS], can be duplicated by a rule of the form (41):

$$(41) \quad \begin{array}{c} V \\ [+PS] \end{array} \rightarrow [1 \text{ stress}] / \underline{\quad} C_0 \#$$

We can then formulate the main stress rule as in (42):

$$(42) \quad \text{Main Stress} \\ V \rightarrow [1 \text{ stress}] / \underline{\quad} (C_0 [1 \text{ stress}]) C_0 \#$$

When (42) applies in its longer expansion, the vowel that earlier bore [1 stress] is reduced to [2 stress] by the Stress

Subordination Convention:

(43)	bisa-hi	libakaw	
		[+PS]	
	---	1 libakaw	Rule (41)
	1 bisa-hi	1 2 libakaw	Main Stress

The invariant penultimate stress found in words with closed penults can be derived using a rule like (44):

(44)	Post-Cluster Stressing
V	→ [1 stress] / CC__C _o #

This rule will feed the Main Stress Rule as follows:

(45)	hambaǵ	gasta	
	[+PS]		
	1 hambaǵ	---	Rule (41)
	1 hambaǵ	1 gasta	Post-Cluster Stressing
	1 2 hambaǵ	1 2 gasta	Main Stress

We now need a set of rules to assign the secondary stresses to the left of the main stress. These stresses, it will be recalled, are applied iteratively, to the syllable immediately preceding another stress if it is long; otherwise to the syllable that is two syllables to the left. This can be done using the disjunctive ordering convention, as in (46):

(46) Secondary Stress

$$V \rightarrow [2 \text{ stress}] / \text{---} C_0 \left(\begin{array}{c} VC \\ [-D] \end{array} \right) \left[\begin{array}{c} V \\ +\text{stress} \end{array} \right] \text{ (iter-} \\ \text{ative)}$$

where [+D] is the diacritic attached to the vowels of ka- and ga-. A typical derivation would be the following:

(47) ma-?-uǵ-ugtas-un

[+PS]

1		
ma-?-uǵ-ugtas-un		Rule (41)
1 2		
ma-?-uǵ-ugtas-un		Main Stress
2 1 2		
ma-?-uǵ-ugtas-un		Secondary Stress
2 2 1 2		
ma-?-uǵ-ugtas-un		Secondary Stress

In some words, such as h-aǵ-ambáǵ-un, this rule will provide too many secondary stresses:

1 2		
(48) h-aǵ-ambáǵ-un		Rule (41), Main Stress
2 1 2		
h-aǵ-ambáǵ-un		Secondary Stress
2 2 1 2		
*h-aǵ-ambáǵ-un		Secondary Stress

After rule (46) has applied to place stress on the second syllable, its shorter expansion will still be applicable, so that stress will incorrectly fall on the first syllable. In order to correct this, we need an additional rule, which will remove the stress from initial short syllables when they are immediately followed by another stress:

$$(49) \left[\begin{array}{c} v \\ 2 \text{ stress} \end{array} \right] \rightarrow [-\text{stress}] / \#C_0 \left[\begin{array}{c} \text{---} \\ -D \end{array} \right] C \left[\begin{array}{c} v \\ +\text{stress} \end{array} \right]$$

The rule must be made sensitive to syllable weight to avoid destressing the first syllable of forms like nāg-kā-sākāy; and it must be sensitive to the feature [+D] in order to avoid destressing the first syllable of examples like kā-?āwat-un-ān.

Several more rules appear to be necessary under the segmental analysis. The first is an analogue to the Destressing rule (30), destressing all initial syllables preceding the main stress:

$$(50) v \rightarrow [-\text{stress}] / \#C_0 \text{---} C_0 \left[\begin{array}{c} v \\ 1 \text{ stress} \end{array} \right]$$

This rule cannot be collapsed with (49), since it applies without regard to syllable weight. A second rule is needed to account for the relative prominence of the weak stresses, as measured by their frequency of appearance in Chai's transcriptions:

$$(51) [2 \text{ stress}] \rightarrow [3 \text{ stress}] / [2 \text{ stress}] P \text{---}$$

Condition: P contains no #.

Finally, rules are needed to account for the pattern of stresses found in reduplicated prefixes, discussed on pp. 55, 56. I will not attempt to formulate these rules here.

Having presented what appears to be the best possible segmental analysis, we turn to a comparison of its merits with those of the metrical theory. There are essentially

three arguments supporting the metrical approach. The first concerns the naturalness of the rules. The segmental analysis requires a Main Stress rule of the form (52):

$$(52) \quad V \rightarrow [1 \text{ stress}] / ___ (C_0 [1 \text{ stress}]) C_0 \#$$

which is a rule that is not attested in any other language I know of. By contrast, the metrical analysis uses rules for constructing and labeling trees which are widespread among the languages of the world, as we shall see.

The second argument concerns the need for a special rule under the segmental analysis (rule (44)) to account for the invariant placement of main stress on closed penults. Under the metrical theory, this is an automatic consequence of the restrictions on foot geometry and the word tree labeling rule, which are both needed independently: the constraints on foot geometry are crucial to the assignment of secondary stress, and the labeling of the word tree is motivated by the stress pattern of words marked [+PS] in the lexicon. The metrical theory is able to provide a unitary explanation for two phenomena which must remain unrelated under other theories.

The third argument concerns the need under the segmental theory for a rule destressing initial short syllables preceding another stress. Under the metrical theory, such syllables are automatically made stressless, since the relevant environment is precisely the one in which syllables can be made the weak member of a foot. The destressing rule seems a particular blot on the segmental theory since it requires reference

to the same division of syllables into CV vs. CVC and CV that
[+D]

the secondary stress assignment rule refers to--the coincidence suggests that the destressing rule is simply an artifact resulting from the wrong formulation of the secondary stress rule.

The reader may wonder if the Destressing rule might be justified on the basis of a general tendency for languages to avoid stress clashes; i.e. adjacent stressed syllables. There are two arguments against this: first, however general the tendency to avoid stress clashes is, it is not especially strong in Aklan, as examples like na-gà-p-à-n-abún and nàg-hi-ŋ-úhà? suggest. Second, we have seen that in Aklan, secondary stresses tend to be stronger if they occur on the left, so that of two initial clashing stresses, we would expect the second, not the first, to be removed.

We conclude from these arguments that the metrical theory is to be preferred to the segmental one: in several cases, it brings us close to an explanation where the segmental theory can provide only a description.

It is worthwhile to ask why the metrical analysis has the advantage here. Generally, the stress pattern displayed by secondary stress in Aklan can be described using two different foot shapes: we can construct binary feet labeled either s w or w s, stipulating in either case that rimes dominated by w may not branch, and that construction must proceed from right to left:

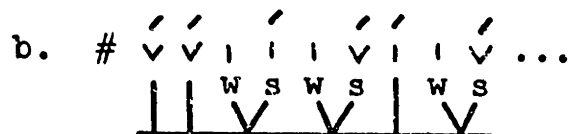
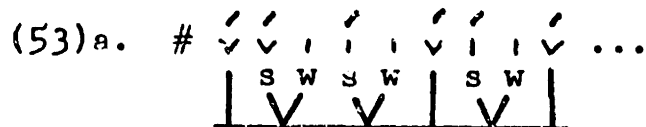

The stress patterns so derived are nearly identical. It is only at the ends of a sequence that the difference becomes crucial: for example, if we add an initial non-branching rime to (53):



we find that the two analyses make differing predictions. In the case of Aklan it is the predictions of (b) that are correct. Our choice of (b) is reinforced by the finding that it can also automatically account for the occurrence of main stress on closed penults, as well as for the occurrence of final secondary stress in words with penultimate main stress.

Consider now which of the rules of a. and b. can be translated into segmental notation using disjunctive ordering. It is clear that (a) can be translated into the rule (55):

$$(55) \quad V \rightarrow [+stress] / \text{---} C_0 (VC) \left[\begin{array}{c} V \\ +stress \end{array} \right] \quad (\text{iterative})$$

In general, metrical rules that construct feet going in the direction "strong nodes first" can be replicated in segmental notation, simply by placing in parentheses the material that may be dominated by weak nodes in the metrical rule. The Latin stress rule of Chapter 1, for instance, translates segmentally into (56):

$$(56) \quad V \rightarrow [+stress] / \underline{\quad} C_0 ((\check{V}C) VC_0) \#$$

However, a rule like b., which constructs feet in the direction "weak nodes first," can be duplicated only with quite complex notation and rule orderings. We see, then, that although the principle of disjunctive ordering determined by parentheses and the Maximal Foot Construction Principle can be employed for very similar descriptive purposes, they are not equivalent in what they can describe. The Aklan case is one in which the Maximal Foot Construction Principle provides a superior description, thus suggesting that the increased power made available by the metrical approach is in fact needed. A parallel, though less intricate case will be presented in the next chapter.

Footnotes to Chapter 2

¹The root putus "wrap" undergoes a sporadic metathesis rule, which applies to clusters derived by vowel dropping whose first consonant is coronal or glottal.

²The /h/ of ?iba-han is epenthetic, appearing whenever two vowels come together through suffixation.

Chapter 3: Tree Geometry

1. Tree Geometry as the Central Part of Metrical Theory

In this chapter we will discuss the central claim of this thesis, which is that the metrical theory provides a simple and illuminating answer to the question of what is a natural stress rule. I want to show that the characteristic stress rules which occur in language after language are all derivable using a fairly simple rule schema, in which a number of parameters may be set independently of one another. It will be seen that the various possible combinations of different settings are attested in numerous languages. Further, a number of possible rule types proposed in previous versions of metrical theory will be seen to be unnecessary, as the phenomena they are designed to account for are better reanalyzed under the more restrictive framework developed here.

As we saw in Chapter 1, a set of metrical stress rules constructs a hierarchy of metrical trees, typically consisting of a foot level and word tree level, although as we shall see, the number of levels is not always two. In addition to the number of levels, other aspects of the rules may vary. The rules may be iterative or non-iterative, and if they are iterative, the direction in which they apply is variable. The shape of the structures created may vary: in particular, the metrical structures may differ in the maximum that is placed on their size, in whether they are right or left branching,

and in the restrictions on what their terminal nodes may dominate. Finally, the procedures for labeling the metrical structures may vary.

A priori, we could imagine theories of universal grammar that would constrain or partially predict any one of these aspects of stress assignment--in fact theories have been proposed for most of them.¹ I will argue here, however, that the principal content of the universal theory of metrical structure lies in the area of tree geometry. I will try to show that the stress systems of a large number of languages can be described using a very small inventory of metrical structures defined by their maximal size and by geometrically stated constraints on what the metrical nodes may dominate. The widespread utility of this system will suggest that it forms the core of universal metrical theory, defining the notion of an unmarked stress rule.

The other aspects of metrical stress assignment vary, I believe, in the degree to which their properties are constrained by universal grammar. It appears that the option of whether a tree construction rule is iterative or not, and the direction in which it applies if it is, are entirely free, determined on a language particular basis. The labeling of the trees seems to have an intermediate status: considerably more variation is found than in tree geometry, but clear unmarked norms and certain absolute constraints are discernable. The universal patterns found in labeling will be discussed in Chapter Four.

The purpose of this chapter is the more important one: to outline and support a restrictive theory of tree geometry. In order to present this theory clearly, a few preliminary matters must be discussed. The first point is that the theory is intended to capture the notion of a natural stress rule, rather than a possible one. I have little doubt that there are a fair number of stress systems that cannot be described strictly within the limits of the theory to be presented. What I am claiming is that such systems will not be especially numerous, and that there will be no systematic class of counterexamples to the theory--in other words, there will be no tree types outside the proposed inventory that are required in language after language. By contrast, all the tree geometries argued for here can be supported by several, if not dozens, of examples. A useful analogy is provided by segmental feature systems. A set of features is intended to capture natural classes of speech sounds, with naturalness expressed as the inverse of the number of features needed to describe a given group of segments. The fact that numerous phonological rules must refer to classes of sounds that must be regarded as unnatural under currently advocated feature systems is not held by most generative phonologists to be reason for abandoning features altogether, since a far greater number of phonological rules can be expressed concisely using features. In order to show that a feature system must be changed, it is necessary to show that a proposed revised system systematically makes better predictions than the old

one. The claim made here, then, is that the foot inventory is the optimal notation for natural stress rules, although not all stress rules are necessarily natural.

2. The Problem of Syllable Quantity

One issue which any metrical theory must address is how to represent distinctions of prominence among syllables for rules that are sensitive to such distinctions. This question is far from resolved, and the proposal I will make here is only tentative. It appears that there are two basic ways in which syllables may be categorized for the purposes of quantitative rules, plus an assortment of marginal, rarer systems. One of the common systems is that which opposes light syllables (i.e. $C_0\check{V}$) and heavy ones ($C_0\bar{V}$, CVC and heavier), as in Latin. This opposition is accounted for nicely by the theories of Vergnaud and Halle (1978) and McCarthy (1979a,b), discussed in the introduction: if we have the stress rules apply on the rime projection, the distinction is one of branching versus non-branching rimes. The grouping together of long vowelled syllables with closed syllables, which must be expressed as a disjunction under segmental theories, is united under the metrical theory provided that long vowels are represented as geminates:

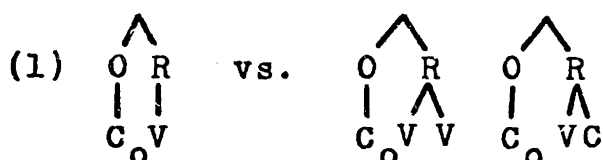

It is interesting that virtually no rules of tree

construction are sensitive to the structure (or even presence) of the syllable onset. To account for this, I will assume that all unmarked stress rules apply on the rime projection.

The other common quantitative opposition of syllable types is that of long vowels and diphthongs versus short vowels. The proper representation of this opposition is not agreed on in the literature. McCarthy (1979a), in discussing the stress system of Tiberian Hebrew (which is based largely on vowel length), suggests that Hebrew syllables which have long vowels are parsed into onset and rime differently than those with short vowels, as follows:

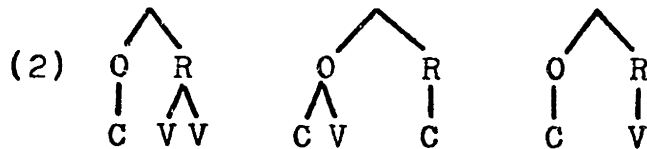

Under this analysis, only syllables with long vowels have branching rimes, so that the relevant criterion for the stress rules is the same as before. However, McCarthy presents little evidence other than the behavior of the stress rules to support the parsings of (2). A priori, his solution seems undesirable, since it forces us to give up a generalization governing the division of syllables into onsets and rimes: as far as evidence such as constraints on syllable structure can indicate, the onset-rime boundary is always placed so that the sonority peak of the syllable falls within the rime. Further arguments against McCarthy's proposal are presented in Section 7 of this chapter.

The proposal to use the [+syl] projection in stress rules is not inconsistent with the assumption made above that all stress rules apply on the rime projection: we can assume that in the relevant languages both projections are in effect simultaneously, filtering through the segments that meet the requirements of both. (Since [+syl] segments are universally absent from the onset, the rime projection will be vacuous in this case.) We can view the rime projection as a universal domain for prosodic rules, with some language specific rules selecting the [+syl] projection as well.

Our proposal depends on the hypothesis that vowel length can always be expressed underlyingly as gemination. To be sure, there are languages in which there is no explicit evidence to this effect. However, as far as I know no one has ever presented evidence showing that length must be represented underlyingly using a feature. There is no reason why the feature theory should have the preferred status of the null hypothesis, especially when there exist languages in which long vowels are quite unambiguously geminate.

One other hypothesis made here is that in languages in which diphthongs pattern with long vowels for purposes of stress, the weaker halves of the diphthongs are phonologically [+syl], so that they will be included in the projection. Again, it is difficult to find evidence to bear on this claim, although the one case I know of is a confirming instance: in Yidin^y, discussed in Chapter 4, the glide /y/ appears in the diphthongs /uy/, /iy/, and /ay/. In the segmental rules of

Yidin^Y, /y/ patterns exactly like a consonant, so that it must be marked as [-syl]. In the stress rules of Yidin^Y, which are sensitive to the distinction of long vs. short vowels, the diphthongs in /y/ pattern as short, which is just what we would predict if the stress rules apply on the [+syl] projection, as (4) shows:

(4) Full Representation syl Projection

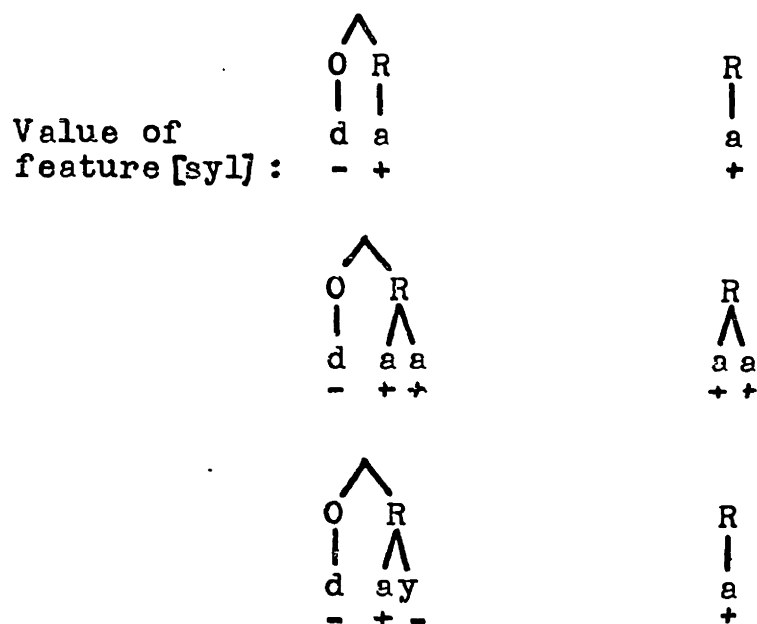

I should point out that if there are exceptions to this hypothesis, the weakening of the theory they would entail would be slight. Imagine, for example, a language that patterned like Yidin^Y in all respects, except that diphthongs counted as heavy for the stress rules, so that their glides had to be included. If such a language were found, we would just allow stress rules to invoke the [-cons] projection as well as the [+syl] projection. However, in the absence of any such counterexamples, we will stay with the stronger theory and

assume that the two unmarked projections for stress rules are the rime projection and the [+syl] projection.

Aside from these two unmarked distinctions of prominence, there remains a motley group of rarer prominence distinctions which stress rules appear to treat in essentially the same manner. Perhaps the most important of these is diacritically marked prominence, exemplified by the analysis of Aklan in the previous chapter. It will be recalled that the Aklan prefixes ka- and ga- behave as if they were metrically heavy, even though they never occur in closed syllables and apparently do not have long vowels. To account for them, I assume a universally available diacritic [+H], which causes stress rules to treat a rime marked with it as if it were branching.

There are two stress rules I know of which refer to a prominence distinction in which closed syllables count as heavy and open ones as light, regardless of vowel length. These are the Main Stress Rule of Tiberian Hebrew, discussed in Section 7 and McCarthy (1979a), and a stress rule of Seneca treated in Stowell (1979). The most tempting analysis of such cases is to say that the stress rules apply to a representation that follows the conversion of underlying geminate vowels to phonetic long ones. If this is true, the relevant distinction for the stress rules would again be that of branching versus non-branching rimes:



However, it is unlikely that this could be correct, since the Hebrew rule in question is ordered before another stress rule which treats syllables with long vowels as heavy, hence as geminate under our theory. A more likely alternative derives from a proposal made by a number of workers (for example Pesetsky 1979, Safir 1979) to the effect that syllables may contain labeled constituents below the rime level, which are called nuclei. Using this proposal, a set of rimes of the form V, VV, VC, VVC might be assigned the structures of (6):

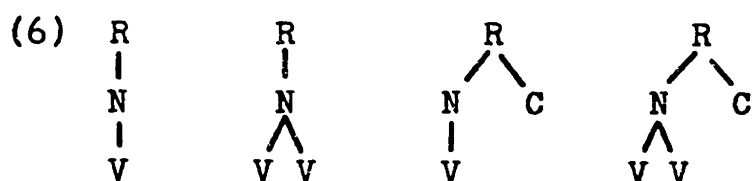

The closed syllable-open syllable prominence distinction can then be captured by stipulating (at some cost in markedness) that branching within the nucleus does not count for the purposes of the stress rules. The utility of the notion of a nucleus is illustrated by its use in Safir's (1979) analysis of Capanahua stress. In Capanahua, a syllable counts as heavy if it is closed by a consonant other than glottal stop. Safir accounts for this by grouping glottal stops together with vowels in the syllable nucleus, so that the syllable rime has the structure of (7):

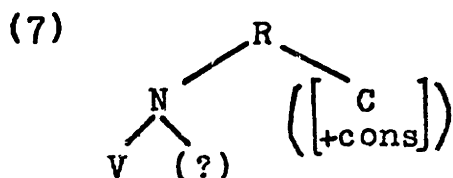

This structure can in fact be motivated independently by the behavior of the segmental rules of Capanahua.

The remaining unusual prominence distinction of which I am aware counts as heavy those syllables marked for high tone or pitch register. This distinction is found in Fore (Nicholson and Nicholson 1962), Golin (Bunn and Bunn 1977), and according to the analysis of Halle and Kiparsky (1979), Proto-Indo-European and a number of its daughter languages. I assume that in such languages the diacritic [+H] is attached to those syllables marked for higher pitch.

The overall picture is this: in the great majority of cases, syllable prominence is determined on a basis that is clearly interpretable as geometric; i.e. the heavy syllables are those whose rimes branch or whose rimes branch on the [+syl] projection. Many of the exceptional cases can be interpreted geometrically if suitable assumptions are made, such as the existence of a nucleus node whose branching is ignored by the stress rule. The remaining exceptions, diacritic prominence and high tone prominence, cannot be interpreted geometrically, but behave in stress rules in a way entirely analogous to geometrically defined prominence, as we will see. The existence of these marginal examples raises the question of whether our assigning primacy to distinctions of branching was right in the first place: might not the distinction of having a branching rime or a long vowel form just a subpart of a more general, though vaguely defined notion of "prominence"? This may be true, but on the basis

which under the criterion of branching are equivalent.

Finally, a theory employing a non-geometrical definition of prominence would be hard put to explain why the cases in which prominence is definable as branching are by far the most common. All these factors suggest that branching is the central, unmarked criterion of prominence, and that the cases of prominence that are not definable as branching are marked, subsidiary phenomena, treated by analogy with the branching cases.

3. A Theory of Tree Geometry

In this section I will present a restricted inventory of unmarked tree shapes. Before discussing the theory, it will be helpful to clarify what I regard to be the correct formal characterization of tree construction rules. A well formed stress rule, I would argue, applies to a string of terminal nodes, brackets them together into the appropriate binary branching tree, and labels the result with a category name α . An example is the following: for the rule of foot formation in Latin, the terminal nodes are the rimes of each syllable of the word, and the constituent created is labeled with the category name Foot. The word tree rule then takes as its set of terminal nodes the foot just constructed, plus any remaining rimes, and creates a single constituent labeled Word Tree. In general, the terminal nodes for a given rule will be the largest prosodic constituents present in the appropriate projection at the point in the derivation where the rule applies, whether they be rimes or trees constructed earlier. What this means is that metrical rules

usually do not break up previously existing constituents; they can only bracket them together. The empirical evidence for this claim will be examined later.

The category names are crucial in determining the geometrical relationship of the various trees to one another. Generally, if two trees of the category α are constructed by two separate rules, or by successive applications of an iterative rule, they will respect one another's boundaries, rather than one dominating or deleting the other. This can be seen in the behavior of the foot construction rule of Aklan: when the rule applies, it respects the foot boundaries created before, either on its previous applications or by the earlier lexically governed foot construction rule (24). By contrast, if two rules construct trees bearing different category names, the rule applying later treats the trees constructed by the earlier rule as terminal nodes, so that one tree forms a constituent of the other, as in Latin word tree construction. We will see later that other modes of rule interaction are sometimes found, but the cases presented here should be regarded as unmarked.

With these preliminaries out of the way, we are now ready to propose a universal unmarked inventory of metrical trees. A priori, it seems clear that an inventory is more likely to be the correct one if relations of symmetry and parallelism hold among its members. Thus the best way to specify an inventory is not by means of a list, but with a set of parameters that may be set independently. One parameter

that we have seen already is the criterion of syllable prominence: metrical structures may count as prominent either branching rimes, long vowels, or occasionally other aspects of the syllable. In addition, many languages draw no distinctions of prominence at all, so that all syllables are treated alike. We will assume that such languages simply ignore all branching within the syllables, so that all syllables are counted as light.

The discussion of the other ingredients of a stress rule will be made clearer if we adopt the terminology of dominant versus recessive metrical nodes: we will say that any pair of sister nodes contains one dominant node and one recessive one. All metrical rules must specify whether in the structures they create it is right nodes or left nodes that are dominant. The single node of a non-branching tree is counted as dominant, for reasons we will see below. Using this terminology, we can now state the principal constraint on rules of tree construction:

- (1) Recessive nodes may not branch.

The constraint (1) has two important consequences. First, metrical rules may only create structures that are uniformly branching: when right nodes are specified as dominant, a right branching tree, i.e. of the form (2):

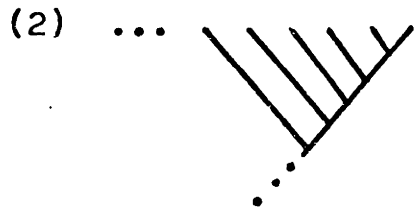

will be created, since a tree having any left branching would contain a branching recessive node. The specification of left nodes as dominant will similarly create a left branching tree. The second consequence of (1) is that if a stress rule pays attention to distinctions of prominence among syllables, all the recessive nodes of any structure the rule creates must be non-branching. For example, in the metrical feet of Aklan, left nodes must dominate a light syllable, i.e. a non-branching rime. This can be accounted for by stipulating that in Aklan feet, right nodes are dominant.

We have not yet stated the principle that determines the possible sizes of metrical trees. I believe that among the unmarked trees, only two sizes are possible: maximally binary and unbounded. These can be produced by specifying either that dominant nodes must be terminal, or that they are free. It should be clear that if dominant nodes must be terminal, the foot will have at most two nodes: any tree that contains more than two terminal nodes would have either a non-terminal dominant node, or a branching recessive node, which is forbidden by (1).

There is one more parameter that may be set freely among the unmarked stress rules: we can specify that dominant nodes

must branch in order for a tree to be formed. Notice that this specification will only be relevant among the feet that are sensitive to prominence distinctions among syllables. If a rule constructs feet that are insensitive to syllable quantity, the dominant terminal node of a foot will necessarily be counted as non-branching, so that no foot could be constructed such that all of its dominant nodes branched.

Let us now summarize the above parameters of tree construction by incorporating them into a general schema, as follows:

(3) Tree Construction

- a. Project rimes. Optionally form a subprojection of [+syl] segments within the rimes.
- b. Select either right or left nodes as dominant.
- c. Form the largest possible binary branching tree, such that recessive nodes do not branch.

Optionally, it may be specified that

- i. All terminal nodes are counted as non-branching.
- ii. Dominant nodes must be terminal.
- iii. Dominant nodes must branch.

The possible outputs of (3) will be made clearer if we develop a notation for foot structures. Let \bar{t} denote a non-branching terminal node, \underline{v} a branching terminal node, and \underline{x} any terminal node, using the appropriate projection if the node in question is a rime. We can then express the inventory of possible

structures as (4):

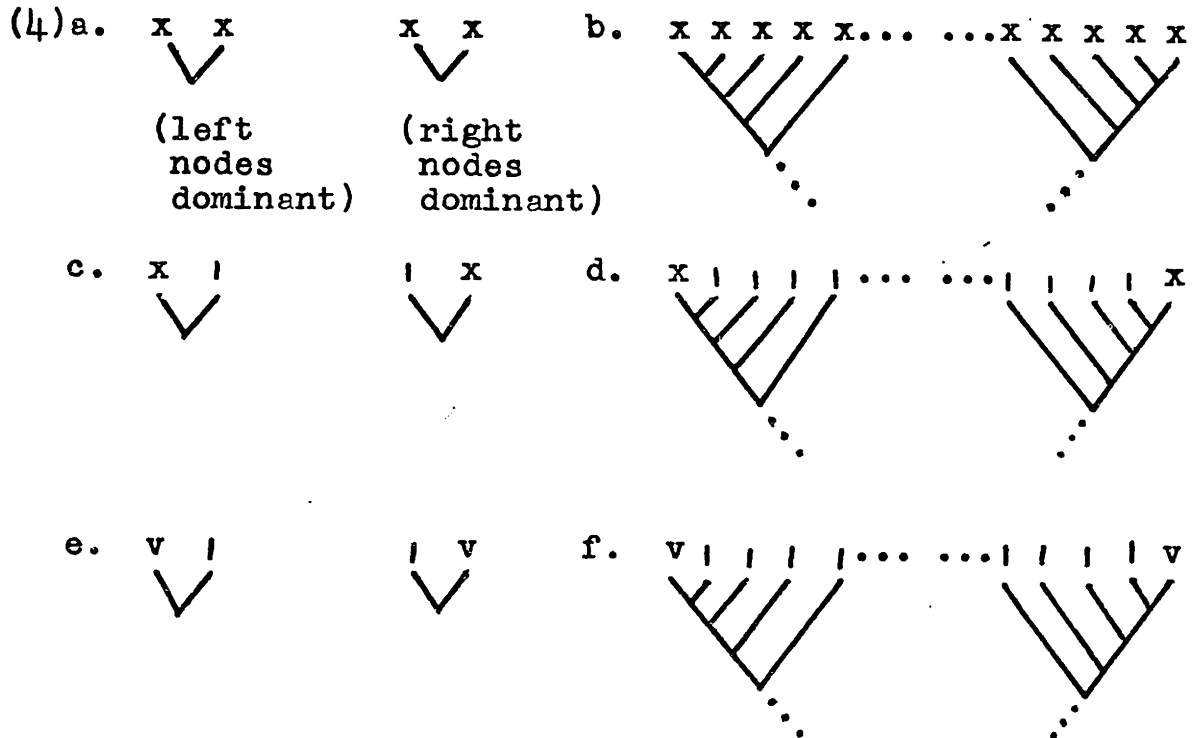

The schemata of (4) represent maximal structures; i.e. the largest trees (possibly infinite) that the relevant rule could in principle construct. A well formed structure for a given rule can be read off the schemata of (4) simply by omitting any number of recessive nodes. For example, the first schema of (4)c stands for the pair of structures in (5):



while the first schema of (4)f represents the infinite set of (6):



languages. (Note that degenerate feet are defined as maximally non-branching, rather than non-branching whenever the configuration of terminal nodes forces them to be so). We can fit degenerate feet into the theory by allowing tree construction rules to stipulate, at a cost of some markedness, that recessive nodes are suppressed.

Let us now adopt some terminology to render the verbal formulation of metrical rules less prolix. We will say that a tree is left dominant or right dominant according to whether left or right nodes have been selected under the provisions of (3)b. In most cases these terms can be translated into the older expressions "left branching" and "right branching." A tree will be called quantity sensitive if the option (c.i) is not selected; that is, if terminal nodes that branch under the appropriate projection are in fact counted as branching. Trees constructed under option (c.i) will be called quantity insensitive. Finally, if the size of the tree is limited by invoking option (c.ii), it will be called binary, otherwise it will be called unbounded.

One more expository convention will be adopted here: we will stipulate that if a foot construction rule mentions a projection, then it constructs quantity sensitive feet. This should cause no confusion, since it is only the quantity sensitive rules in which a projection has to be specified.

4. Exemplification

In justifying a foot inventory as the unmarked one, a minimal requirement is to show that all the members of the

- b. mérepèt "beard"
 c. yángarmàta "the Pleiades"
 d. lángkaràteti "prawn"
 e. wélepènemànta "kind of duck"

These facts fall out from the following metrical analysis:

- (2)a. Going from left to right, construct binary, quantity insensitive, left dominant feet.
 b. Group the feet into a left dominant word tree.

The unmarked labeling convention making dominant nodes strong will label both feet and word tree as s w:

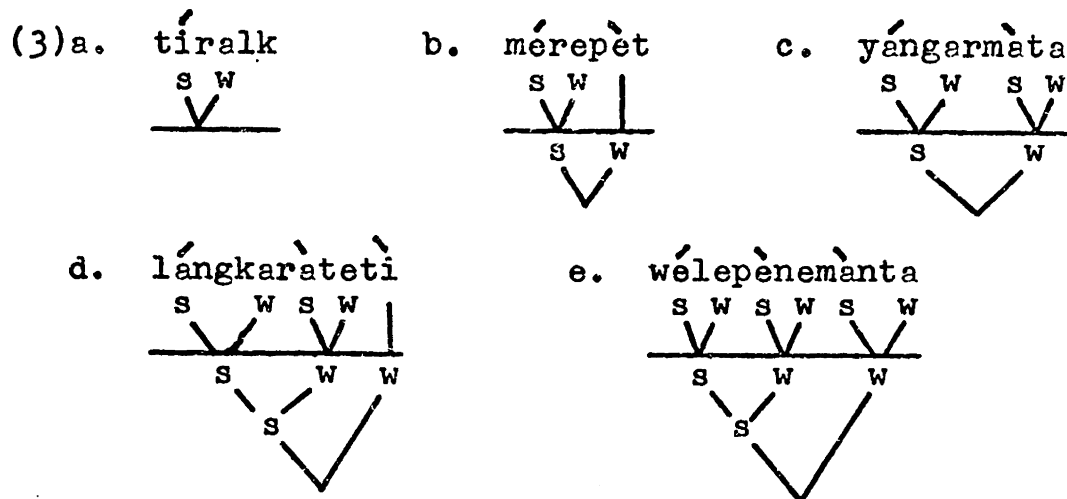

In Warao (Osborn 1966), main stress normally falls on the penult, with secondary stresses falling on alternating syllables before the main stress:

- (4)a. yàpurùkitàneháse "verily to climb"
 b. nàhoròahàkutái "the one who ate"
 c. yiwàranáe "he finished it"

- d. enàhoròahàkutáí "the one who caused him to eat"

This would require construction from right to left of binary, quantity insensitive, left dominant feet, with a right branching word tree. The resulting structures will be as in (5):

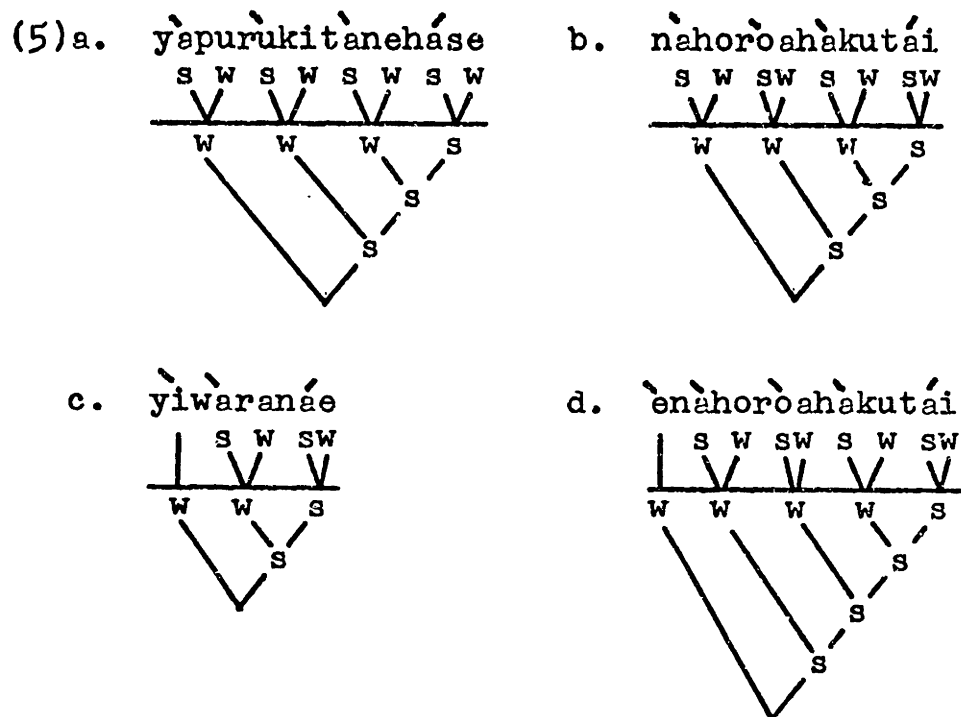

These trees must be adjusted when the word has an odd number of syllables so that stress will not fall on the initial syllable. This can be accomplished by a simple destressing rule of the form (6):

$$(6) F \rightarrow \emptyset / \text{---} \text{---} \text{---}$$

That is, remove feet which do not branch. Syllables so destressed will be incorporated into the word tree by a rule

to be discussed later. The surface forms of (5)c and d will look like this:

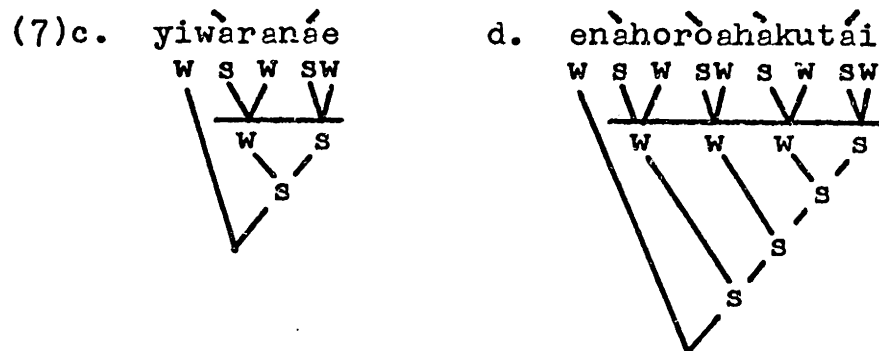

In Weri (Boxwell and Boxwell 1966), main stress is assigned to final syllables, with secondary stresses assigned to each preceding alternate syllable. This follows from the construction of binary, quantity insensitive, right dominant feet from right to left. The word tree is quantity insensitive, right dominant, and unbounded:

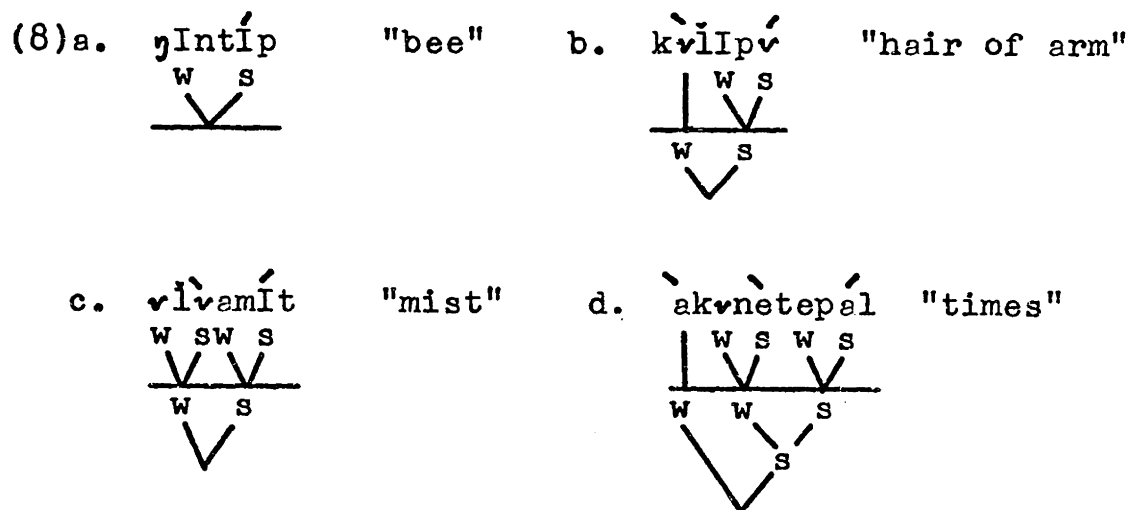

Southern Paiute (Sapir 1930) illustrates the fourth possible case: here the right nodes of the feet again are dominant, but the feet are assigned from left to right. With

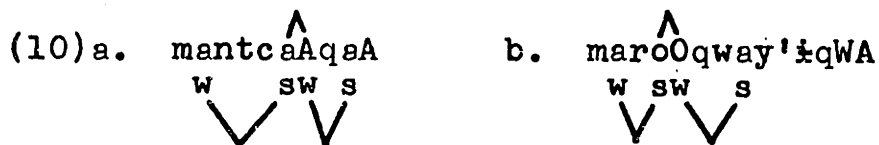

This is a problem for our theory, in which tree construction is envisioned as a process of bracketing together constituents that already exist on a lower level. Fortunately, it appears that the "moras" of Southern Paiute must be regarded as separate syllables in underlying representations. For example, some of the allophonic rules for vowels, as in (11):

- (11) a. $a \rightarrow \wedge / \text{ }^{\circ}\text{C}_o\text{---}$
 b. $\ddot{i} \rightarrow i / \text{---C}_oi$

apply only to one "half" of a surface long vowel, so that (11)a will convert aa into Λa and (11)b will change ḡḡ to ḡi. Since allophonic rules typically treat long vowels as units, it is probable that VV sequences count as bisyllabic at the time (11) applies. The vowel devoicing rules of Southern Paiute, which devoice certain metrically weak vowels, similarly treat surface long vowels as bisyllabic. These facts suggest that the formation of long vowels from adjacent vowels is a fairly late phonetic rule. The existence of such rules is supported by analogous cases in which the syllable merger is optional. For example, Blake (1969) reports that in Kalkatungu, the relevant unit for stressing is the syllable, but that adjacent vowels stressed as $\overset{\vee}{V}V$ or $V\overset{\vee}{V}$ may in fast speech be heard as single long stressed vowels. A similar process is described for Macedonian by Lunt (1952). We

conclude that our hypothesis that syllable bracketings are respected by tree construction rules is not refuted by the facts of Southern Paiute. It is too early to know whether more convincing counterexamples will show up, but it seems best to retain the strongest hypothesis consistent with the facts.

Numerous other examples of binary, quantity insensitive foot assignment can be presented. In Garawa (Furby 1974), main stress falls on the initial syllable, secondary stress on the penultimate, and tertiary stress on alternating syllables preceding the penult. However, non-primary stress may never occur on syllables directly following the main stress. This suggests the following analysis:

- (12)a. Assign a binary, quantity insensitive, left dominant foot at the left edge of the word.
- b. Group the remaining syllables of the word into similar feet, going from right to left.
- c. Form a left dominant word tree. Remove non-branching feet.

This will produce the following structures:

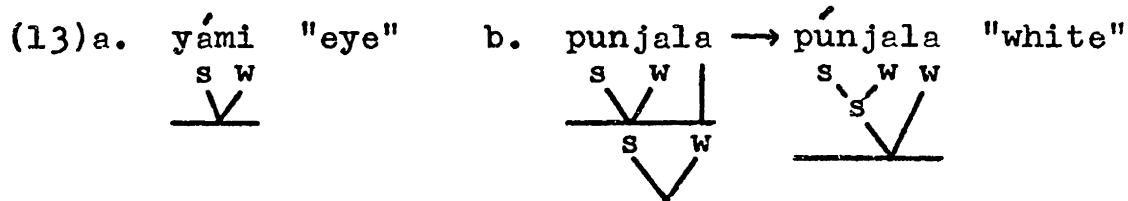

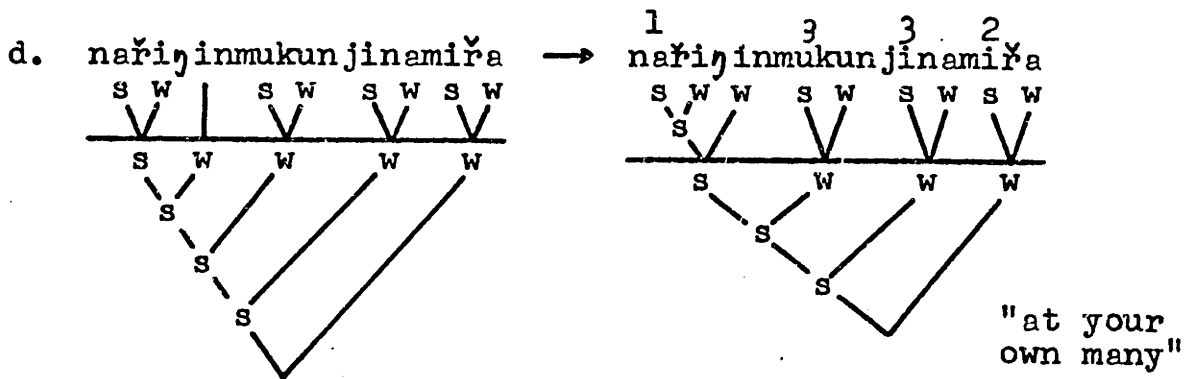
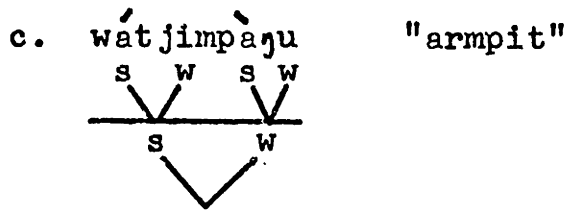

The destressed syllables in (13)b and d are adjoined to the preceding foot by a universal convention, whose operation will be explained later. Notice that the ranking of the secondary stresses in (13) is predicted by the principle that the prominence of weak feet is inversely proportional to their depth of embedding, assuming that stresses weaker than secondary in Garawa are indistinguishable from one another.

It is interesting that quantity insensitive binary tree structures need not always be feet; i.e. they need not directly dominate rimes. Stowell (1979), drawing on work by Phil LeSourd, describes Passamaquoddy as having a stress pattern in which the metrical feet, rather than the syllables, alternate in prominence. Main stress falls on the strong syllable of the penultimate foot, with secondary stress on alternating feet before it. Thus in Passamaquoddy, there must be three metrical levels: the foot (which will be described later), the quantity insensitive binary structures dominating the

requiring a marked labeling convention, while that of (15) can dispense with the extra rule needed to construct the word final foot. However, even if all penultimate stress languages are analyzed as in (15), the unmarked status of quantity insensitive binary feet is secure, owing to the great number of cases in which such feet must be constructed iteratively.

4.2 Unbounded Quantity Insensitive Trees

I have little to say about these metrical structures. Typically languages in which they are assigned have initial or final stress, since there is nothing to prevent an unbounded foot that is insensitive to quantity from encompassing the entire word. Hyman (1977) lists 114 languages with "predominant" initial stress and 97 languages with "predominant" final stress. To be sure, many of these languages have secondary stress which must be accounted for by assigning foot structures other than unbounded quantity insensitive ones, but a fair number do seem to have just plain initial or final stress.

In languages that have word trees (i.e. the vast majority of stress languages), the word tree must be unbounded and quantity insensitive, since no other type of tree under the theory is guaranteed to assign a prominence value to all the feet or syllables of the word, presumably a necessary requirement for stress rules. A few languages are described as having a number of equally prominent stresses, for example Tübatulabal (see below), Nirgil (Manning and Jagers 1977), West Greenlandic Eskimo (Schultz-Lorentzen 1945), Angula

(Kirton 1977), and Auca (Pike 1964). This suggests that the construction of a word tree is optional in universal grammar, but that its absence is marked.



4.3 Unbounded, Quantity Sensitive Trees

Feet of this sort can account for a stress pattern which is often discussed in the literature, that of Eastern Cheremis (see for example Kiparsky 1973, Ingemann and Sebeok 1961, Itkonen 1955). In Eastern Cheremis the vowels fall into two categories, termed full and reduced. I assume that this distinction is underlyingly one of vowel length; i.e. of gemination. This assumption can be motivated in two ways: first, the full vowels are phonetically longer than the reduced ones; and second, there are apparently no languages having an underlying three-way distinction of the type reduced vowel:full short vowel:full long vowel. This would follow automatically from the assumption that both the full-reduced and the long-short distinctions must be represented underlyingly as gemination.

Stress in Eastern Cheremis falls on the last full vowel of a word, and on the initial vowel if the word contains only reduced vowels. This pattern can be captured as follows:

- (16)a. Projecting (+syl) segments within the rime, form a left dominant, unbounded foot at the right edge of a word.
- b. Form a right dominant word tree.

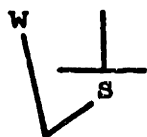
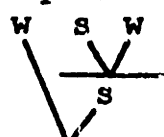
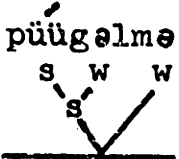
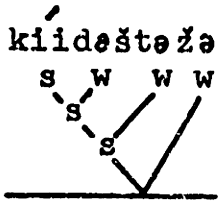
Some examples of the application of this rule are as follows:

- (17)a. šinčáam "I sit"

- b. šlaapáažəm "his hat (acc.)"

- c. püügəlmə "cone"

- d. kiidəštəžə "in his hand"

- e. tšəlezən "moon's"

We have no information on secondary stress in Eastern Cheremis. The foot construction rule may well be iterative, assigning secondary stress to long vowels and initial syllables preceding the final foot. An interesting aspect of the Eastern Cheremis foot is its interaction with a rule of vowel harmony, whose effects are ignored in the representations of (17) (for discussion see Hayes 1979a). Briefly stated, Vowel Harmony assimilates a reduced vowel in backness and rounding to the last preceding full vowel, or else the initial vowel in words lacking full vowels. More perspicuously, we can say that Vowel Harmony applies within the foot. Since Kiparsky (1979) has shown that segmental rules may be sensitive to foot boundaries, the vowel harmony facts of Eastern Cheremis provide independent support for the constituent structure assigned by the rules of (16).

The well known counterpart to Eastern Cheremis is found in the Eastern Permyak dialects of Komi, in which stress falls

on the first "heavy" vowel, and on the final vowel in words without heavy vowels. Such a stress pattern is simply the mirror image of the Eastern Cheremis one, formed by reversing the specification for dominance in the foot construction rule, applying it at the left edge of a word instead of the right, and reversing the dominance of the word tree as well.

There are several other languages whose stress patterns have simple analyses requiring unbounded, quantity sensitive feet. These are described briefly as follows:

(18)a. Koya (Tyler 1969)

Primary stress falls on the initial syllable, secondary stress on closed syllables or syllables with a long vowel.

Analysis: Feet are unbounded, assigned on the rime projection. Both feet and word trees must be left dominant.

b. Huasteco (Larsen and Pⁱke 1949)

Stress the rightmost long vowel, otherwise the initial syllable.

Analysis is as in Eastern Cheremis. A rule assigning intonation contours to words apparently applies within the domain of the foot.

c. Chavash (Krueger 1961)

Stress the last full vowel, otherwise the first syllable.

Analysis is as with Eastern Cheremis and

Huasteco.

d. West Greenlandic Eskimo (Schultz-Lorentzen 1945)

Stress syllables with branching rimes and final syllables.

Feet are right dominant, constructed on the rime projection. Apparently there is no word tree.

A fair number of additional cases will be presented later in this chapter and in Chapter 4.

4.4 Binary, Quantity Sensitive Trees

We have already seen an example of this type of tree in Aklan. We can reformulate the Aklan foot construction rule in our universal framework as follows:

- (19) Going from right to left on the rime projection, construct feet in which
- a. Right nodes are dominant
 - b. Dominant nodes are terminal.

This will produce the correct inventory of feet, as follows:

- (20)
$$\begin{array}{c} \text{CVCV(C)} \\ \begin{array}{cc} \text{w} & \text{s} \\ \vee & \\ \text{CV(C)} & \end{array} \\ \begin{array}{c} | \\ \text{F} \end{array} \end{array}$$
 in the environment / $\left\{ \begin{array}{c} \# \\ \text{CVC} \end{array} \right\}$ —

Recall that two prefixes in Aklan, ka- and ga-, behave in the same way as closed syllables for purposes of stress. We can

account for this behavior by marking them with the diacritic [+H] mentioned above, which causes them to be treated as honorarily heavy. More specifically, we can propose the following:

- (21) Rules of foot construction must treat rimes marked [+H] as dominant nodes.

It should be clear that in a language like Aklan, in which all rimes are gathered up into feet, the principle (21) will insure that any rime marked [+H] will receive stress. However, the diacritic [+H] should not be equated with the feature [+stress]. For example, there might be languages in which stress falls on the rightmost rime marked [+H], with no secondary stress--a good candidate for such a language would be Catalan, as described in Mascaro (1976). To describe this pattern, we would have a left dominant foot constructed at the right edge of a word, plus a right dominant word tree, as in (22):

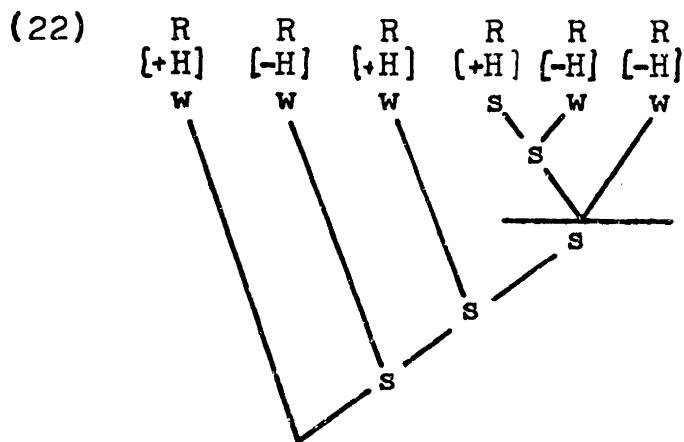

This would suffice to make all rimes marked [+H] stressless except the rightmost one: these rimes would be recessive

nodes, but within the word tree, not the foot, so that (21) is not violated.

As I pointed out in Chapter 2, feet in Aklan are assigned in a way that cannot be duplicated with segmentally based disjunctive ordering notation--the feet are right dominant, but are assigned from right to left. This pattern is not unique to Aklan, as a very similar stress system is found in Tübatulabal (Voegelin 1935). Aside from certain complications discussed in Howard (1972), stress in Tübatulabal falls on (a) final vowels; (b) long vowels; (c) short vowels lying two syllables to the left of a stress. To handle this, we can assign binary, right dominant feet on the [+syl] projection, going from right to left:

- (23)a. taaháwilaap "in the summer"
- b. pítípítíidinát "he is turning it over repeatedly"
- c. íí?ííí?áánicá "he will meat-fast"
- d. pónihwín "of his own skunk"

As Voegelin claims that the stresses are all equally prominent, we assume that there is no word tree. Just as in Aklan, certain short vowels in Tübatulabal receive stress regardless of their position. This can be handled as before, by marking

these vowels as [+H], forcing their syllables to appear in dominant position. An example of a vowel marked [+H] is the final vowel of the stem tuguwa- "meat". The effect of this marking can be seen in the examples below:

- (24)a. $tuguwa-n \xrightarrow{[+H]} \begin{array}{c} \acute{t}u\acute{g}u\acute{w}a\acute{n} \\ | \quad w \quad s \\ \hline \end{array}$ "his meat"
- b. $tuguwa-yi-n \xrightarrow{[+H]} \begin{array}{c} \acute{t}u\acute{g}u\acute{w}a\acute{y}i\acute{n} \\ | \quad w \quad s \quad | \\ \hline \end{array}$ "his meat-obj."

We can also find a fair number of cases in which binary, quantity sensitive feet are assigned in the direction "dominant nodes first"--i.e., the direction in which the metrical analysis can be duplicated using the disjunctive ordering convention. For example, in Creek (Haas 1977), the tonal accent is predictable in a large class of words. Vergnaud and Halle (1978) formulate a metrical rule to place the accent which uses binary, quantity sensitive feet. Stated in our framework, the rule is as follows:

- (25)a. On the rime projection, going from left to right, form binary, right dominant feet.
- b. Incorporate the feet into a right dominant word tree, labeling dominant nodes as strong if and only if they branch.

This analysis provides the correct stressings as follows:

(26)a. ifá "dog"

 A metrical tree for 'ifá'. The root node branches into 'w' and 's'. 'w' branches into 'i' and 'f'. 's' branches into 'á'. A horizontal line is drawn below 'i', 'f', and 'á'.

b. ifóci "puppy"

 A metrical tree for 'ifóci'. The root node branches into 'w' and 's'. 'w' branches into 'i' and 'f'. 's' branches into 'ó'. 'i' branches into 'c'. A horizontal line is drawn below 'i', 'f', 'ó', and 'c'. Below this line, 's' and 'w' are positioned, with lines connecting 's' to 'f' and 'w' to 'c'.

c. itiwanyipita "to tie each other"

 A metrical tree for 'itiwanayipita'. The root node branches into 'w' and 's'. 'w' branches into 'i' and 't'. 's' branches into 'i' and 'w'. 'i' branches into 'a'. 'w' branches into 'n'. 's' branches into 'y'. 'i' branches into 'p'. 's' branches into 'i'. 't' branches into 'a'. A horizontal line is drawn below 'i', 't', 'w', 'n', 'y', 'p', 'i', and 'a'. Below this line, 'w', 'w', 's', and 'w' are positioned, with lines connecting 'w' to 't', 'w' to 'n', 's' to 'p', and 'w' to 'a'. Further down, 's' and 's' are positioned, with lines connecting 's' to 'p' and 's' to 'i'.

d. pócóswa "axe"

 A metrical tree for 'pócóswa'. The root node branches into 'w' and 's'. 'w' branches into 'p'. 's' branches into 'ó'. 'c' branches into 's'. 'w' branches into 'a'. A horizontal line is drawn below 'p', 'ó', 's', and 'a'. Below this line, 's' and 'w' are positioned, with lines connecting 's' to 's' and 'w' to 'a'.

e. hoktaki "women"

 A metrical tree for 'hoktaki'. The root node branches into 'w' and 's'. 'w' branches into 'h'. 's' branches into 'o'. 'k' branches into 't'. 'i' branches into 'a'. A horizontal line is drawn below 'h', 'o', 't', and 'a'. Below this line, 'w' and 's' are positioned, with lines connecting 'w' to 't' and 's' to 'a'.

f. yakaphoyita "two to walk"

 A metrical tree for 'yakaphoyita'. The root node branches into 'w' and 's'. 'w' branches into 'y'. 's' branches into 'a'. 'k' branches into 'p'. 'h' branches into 'o'. 'y' branches into 'i'. 't' branches into 'a'. A horizontal line is drawn below 'y', 'a', 'p', 'o', 'i', and 'a'. Below this line, 'w', 's', and 'w' are positioned, with lines connecting 'w' to 'p', 's' to 'o', and 'w' to 'i'.

A number of metrical analyses presented in the literature posit foot construction rules quite similar to that of Creek. Stowell (1979) presents an analysis of stress in Passamaquoddy based on work by Phil LeSourd, in which the rule of foot construction is essentially as in (21)a. The only difference is that the rule is sensitive to the prominence distinction of full vs. reduced vowels rather than heavy versus light syllables. This can be captured under our theory by representing the full vowels as underlying geminates (they are phonetically longer than reduced vowels), and having the rule apply on a [+syl] projection. The Passamaquoddy rule is especially interesting because of its interaction with other rules. A rule of vowel deletion drops reduced vowels whenever they are

weak within a foot and precede an obstruent. Since this rule would be extremely complicated to formulate without reference to foot structure, it provides independent support for the metrical analysis. The other interesting aspect of the Passamaquoddy system is that the feet are not directly incorporated into a word tree, but rather into an intermediate level of structure (described above, p. 93), which is then incorporated into the word tree.

There exist other examples of iterative assignment of binary, quantity sensitive feet. Pesetsky's (1979) metrical analysis of Menomini provides an interesting case of the role of metrical structure in determining vowel length. It employs a foot construction rule identical to that of Passamaquoddy, to which Menomini is related. The stress facts of St. Lawrence Island Eskimo (Anderson 1974) also appear to require a rule of this type. An ingenious account of the recessive accent rule of Ancient Greek appears in Steriade (1980). The feet constructed here are left dominant, assigned iteratively from right to left. Two further examples, the Vowel Reduction rule of Biblical Hebrew and the stress rule of Cairene Arabic, will be discussed below.

Not all rules assigning feet of this type are necessarily iterative. For example, in Ossetic (Abaev 1964), stress falls on the first vowel of a phrase if it is long, otherwise on the second vowel. This suggests the analysis of (27):

- (27)a. At the left edge of a phrase, form a binary, right dominant foot on the [+syl] projection.

left

b. Form a dominant word tree.

Examples of the application of (27) are as follows:

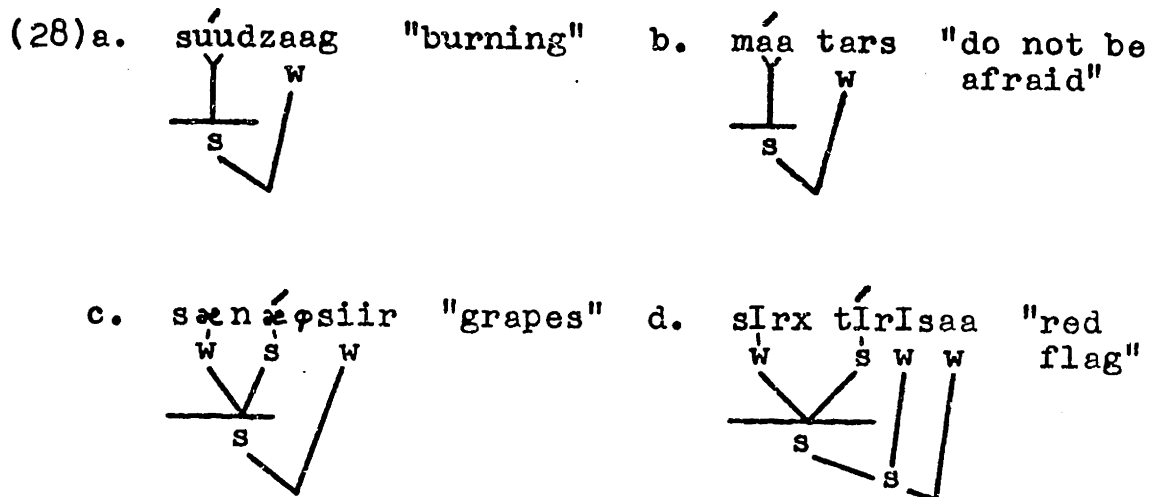

This pattern is overridden in definite nouns, where stress is always initial:

(29)a. bælaás "a tree" b. bælaas "the tree"

This can be handled by suppressing foot construction, rule (27)a, in definite nouns. The word tree construction rule will then supply these nouns with initial stress.

Rotuman (Churchward 1940) is the mirror image of Ossetic: stress falls on the final vowel if it is long, otherwise on the penult:

(30) táka "lie down"
 hununúka "gasp for breath"
 maróo "to be taut"
 kararáa "snore"

The analysis is the same as in Ossetic, except that the dominance of foot and word trees is reversed, and the feet are assigned at the right edge of the word.

A caveat is in order concerning the last two examples: as we shall see in the next chapter, they are amenable to an analysis in which the facts are accounted for by tree labeling rather than foot construction, just like the case of penultimate stress. But the unmarked status of binary quantity sensitive feet is established anyway by the iterative examples presented in this section and below.

4.5 Trees in Which Dominant Nodes must Branch

In a number of languages that place stress on the leftmost or rightmost heavy syllable, the default case that applies in words that don't have any heavy syllables is the opposite of what we have seen before: we get final stress if stress goes on the rightmost heavy syllable in words that have one, and initial stress if stress would otherwise go on the first heavy syllable. The latter pattern is found for example in Khalkha Mongolian (Street 1963), where the prominence distinction among syllables is that of long versus short vowels. Our account of such stress systems is based on an idea of Vergnaud and Halle (1978): we require in certain stress systems that if any foot is to be constructed, all of its dominant nodes must branch. The possible feet of Khalkha would be as in (31):

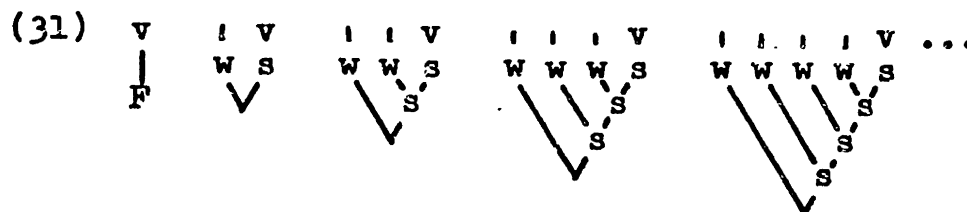

Feet which don't dominate a long vowel are excluded. If such feet are constructed at the left edge of a word in Khalkha, the correct stresses appear with a left dominant word tree:

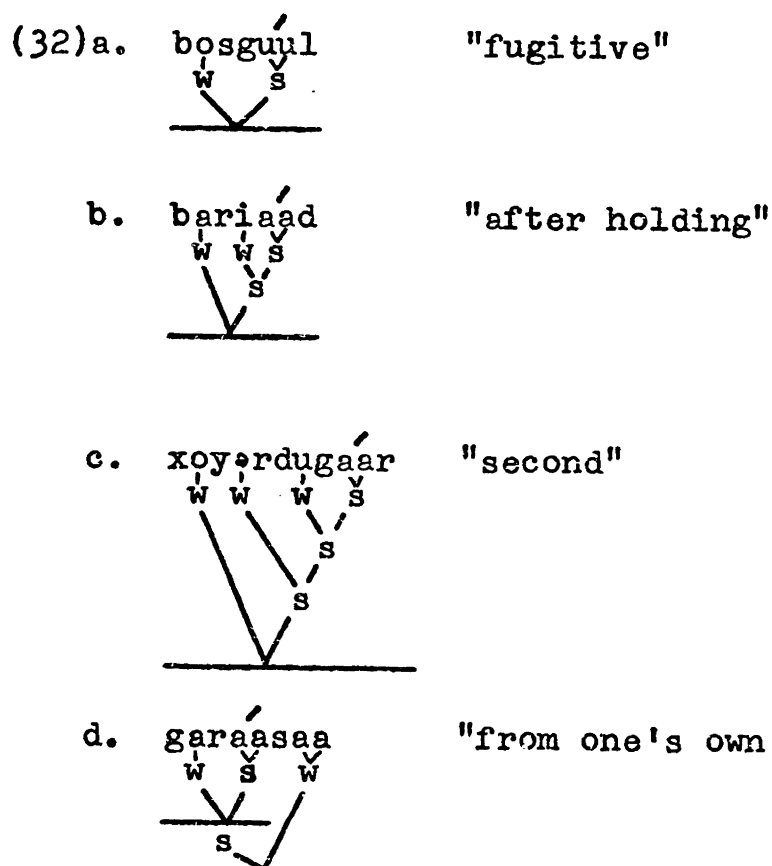

If a word consists solely of light syllables, then no foot may be constructed, since such a foot would have a non-branching dominant node (rightmost one). Thus the only metrical structure that is created is the word tree, which must always be quantity insensitive. Initial stress results, as in (33):

- (33)a. $\acute{a}li$ "which"
 $\begin{array}{c} s \quad w \\ \vee \end{array}$
- b. $\acute{x}ó\acute{t}óbərə$ "leadership"
 $\begin{array}{c} s \quad w \quad w \quad w \\ \begin{array}{c} s \quad \diagdown \\ \diagup \quad s \end{array} \\ \vee \end{array}$

A number of languages have stress patterns similar to Khalkha, and would be stressed using the same approach:

- (34)a. Yana (Sapir and Swadesh 1960)

Stress the leftmost syllable with a branching rime, otherwise the initial syllable.

Analysis: same as Khalkha, except on rime projection.

- b. Aguacatec Mayan (McArthur and McArthur 1956)

Stress the rightmost syllable with a long vowel, otherwise the final syllable.

Analysis: mirror image of Khalkha.

- c. Fore (Nicholson and Nicholson 1962)

Stress the first syllable having a high tone, otherwise the first syllable.

- d. Golin (Bunn and Bunn 1977)

Stress the last syllable having a high tone, otherwise the last syllable.

Note that the latter two languages have a marked criterion of syllable prominence, high vs. low tone. According to Halle and Kiparsky (1979), Proto-Indo-European and several of its daughter languages had accent systems of the type

presented in this section, although certain complications preclude discussion here. In addition, we will see later in this chapter that secondary stress in Tiberian Hebrew is governed by the construction of feet similar to those of Aguacatec.

Since there appears to be good evidence for allowing stress rules to require that dominant nodes branch in unbounded feet, the logical question to ask is whether the same constraint is observable in binary feet. The answer appears to be yes: for example, in the native vocabulary of Yapese (Jensen 1977), stress is final except in cases where the final vowel is short and the penultimate vowel is long. This suggests the following analysis:

- (35)a. At the right edge of a word, form a binary, left dominant foot on the [+syl] projection, in which the dominant node must branch.
- b. Form a right dominant word tree.

Words like saálap "expert", magpáa? "wedding" will have a foot constructed at their right edges, and thus will receive penultimate and final stress respectively.

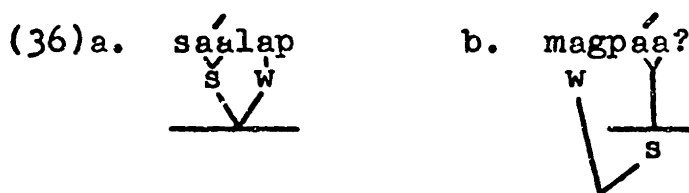

In words like pa?á "my hand", no foot will be constructed, since such a foot would necessarily have a non-branching

dominant node. The word tree thus assigns them final stress:

(37) pa?ag
 w s
 V
 —

Stress patterns of the Yapese type are attested elsewhere: for example, the mirror image stress pattern is reported for Gurkhali (Meerendonk 1949), Malayalam (Mohanam, oral presentation 5/79), and the Waalubal dialect of Bandjalang (Crowley 1978).² In addition, a rule of binary foot construction in which the dominant node must branch has also been proposed by Pesetsky (1979) in his analysis of Menomini vowel length.

This concludes the presentation of stress rules in which the trees generated by the procedure of Section 3 are used in their simplest form (other cases, employing other formal devices, are presented below). It can be seen that each proposed foot structure is supported by a fair number of cases. It is encouraging that the other ingredients of foot construction, such as the criterion of syllable prominence, the direction of branching, iterativeness, and the direction of assignment by and large may vary freely for a given foot geometry. It is a natural consequence of our theory that these factors should be independent. Because the metrical theory breaks down a stress rule into a set of ingredients, it captures the underlying similarity among a very wide set of stress rules by pointing out their identity at the geometric level.

5. Feet with Extra Final Nodes

The literature contains a fair number of proposed stress rules that appear to form systematic exceptions to the theory presented in the previous section. The most famous of these is the stress rule of Latin, discussed in Chapter 1:

(1) Latin Stress

- a. Stress the penult if it is heavy, and in bisyllables.
- b. Otherwise stress the antepenult.

The Latin rule seems to require construction of feet having the maximal form of (2):

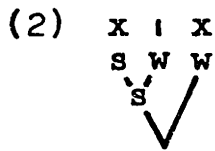

in other words, maximally ternary feet in which the middle node must not branch:

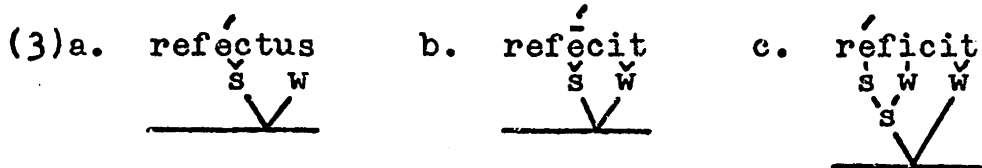

But the type of foot involved would be impossible under the theory of the previous section, which allows only binary feet, and further claims that if a foot is quantity sensitive, all of its recessive nodes must dominate a light syllable. The Latin rule is not an isolated case. For example, McCarthy (1979a) proposes essentially the same rule

for Damascene Arabic, and the geographically remote Arabic dialect of the Sudan (Worsley 1925) displays the Damascene pattern as well. In addition, the Chimwi:ni language (Kenstowicz and Kisseberth 1977, Kisseberth and Abasheikh 1973, Goodman 1967) appears to have possessed a Latin-like stress rule at some stage of its history. For the present language, Kisseberth et al. postulate a complex set of vowel shortening rules, which have the collective effect of shortening all vowels except the one that would be stressed by a rule of the Latin type--i.e. the penult if it is heavy, otherwise the antepenult. It is not clear whether modern Chimwi:ni vowel shortening is a metrical rule, since stress now follows a different pattern and borrowings have obscured some of the shortening rules. But the historical existence of a Latin-like stress pattern as the source of present day shortening is quite likely.

Before accounting for this set of putative counter-examples, it will be necessary to present two further sets, the first of which involves unbounded feet. McCarthy (1979a,b) describes the stress facts of Classical Arabic essentially as follows:

- (4)a. Stress the rightmost heavy syllable that is non-final.
- b. Otherwise stress the initial syllable.

The foot structure McCarthy uses to account for these facts is (in our terms) left dominant, quantity sensitive, and

unbounded, with all recessive nodes forbidden to branch except the rightmost:

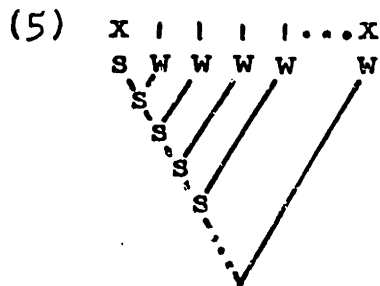

Some examples are:

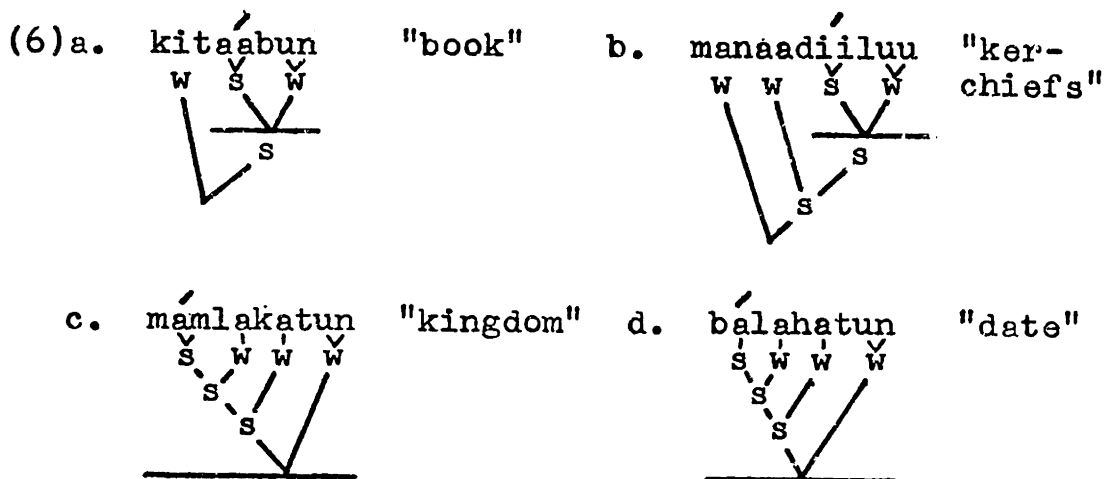

There are other languages which might be described in the same way, for example Dongolese Nubian (Armbruster 1960), Mountain Cheremian, and Hindi (the latter two are described below).

The final group of putative counterexamples consists of languages that assign stress at most three syllables from the beginning or end of a word. For example, in Macedonian (Vergnaud and Halle 1978, Lunt 1952) and in Parkalla nouns (Shürmann 1844), stress is placed initially in bisyllables and on the third syllable in longer words. Similarly, in

Winnebago (Hale and White Eagle 1979), stress is final in bisyllables and on the third syllable in longer words, prior to the application of other rules. These stress patterns suggest that the inventory of unmarked feet might have to be expanded to include quantity insensitive ternary ones as well:

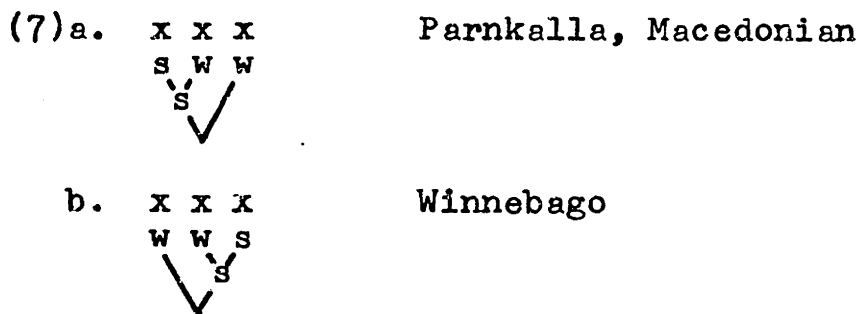

In class lectures, Morris Halle has proposed an unmarked foot inventory that is somewhat larger than mine, which is designed to take care of the above three cases. It includes all of the foot schemata included in the inventory of Section 3, but extends the inventory in two directions: ternary feet are allowed; and among the quantity sensitive feet, it is permitted for the least deeply embedded recessive node to branch at the rime level--in other words, the leftmost node of a right branching foot and the rightmost node of a left branching foot may optionally be made free. Halle's inventory is summarized under (8) (p. 114), with the new additions outlined. (Only the left branching version of each foot schema is illustrated.)

(8) Halle's Proposed Foot Inventory

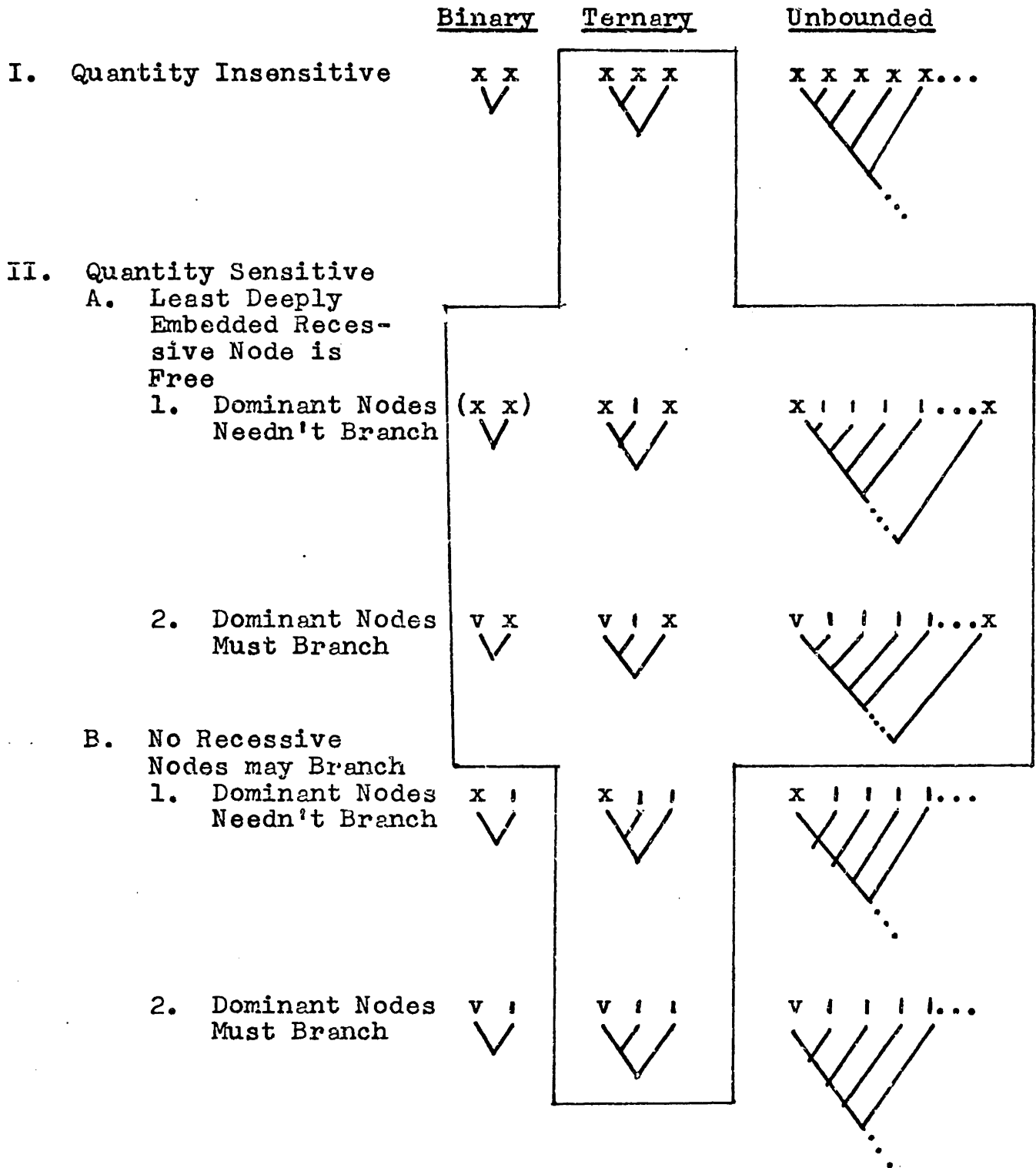

The new additions, in particular $x \mid x$, $x \mid \mid \mid \dots x$,

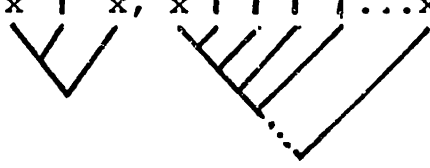

and $x \ x \ x$, can handle stress rules such as those of Latin,



Classical Arabic, and Macedonian respectively, but at a substantial cost, since the theory's definition of what constitutes an unmarked stress rule has been widened considerably.

I will show here that a better theory is available, one which accounts for the same facts, but which retains the smaller foot inventory and predicts a far smaller number of unmarked stress rules. To begin with, observe that some of the additions to the inventory that Halle proposes are completely unattested: I know of no languages whose stress patterns could be simply described using feet of the form

$x \mid \mid$ or $v \mid \mid$. The ^{foot} $v \mid x$ could be used in certain stress

rules, but in each such case other devices are available to capture the same facts. The remaining feet share a property in that they can be decomposed into a foot taken from the inventory of Section 3, plus an extra free node tacked on:

$$(9)a. \quad x \ x \ x = x \ x + x \quad b. \quad \begin{matrix} \{v\} \\ \{x\} \end{matrix} \mid x = \begin{matrix} \{v\} \\ \{x\} \end{matrix} \mid + x$$

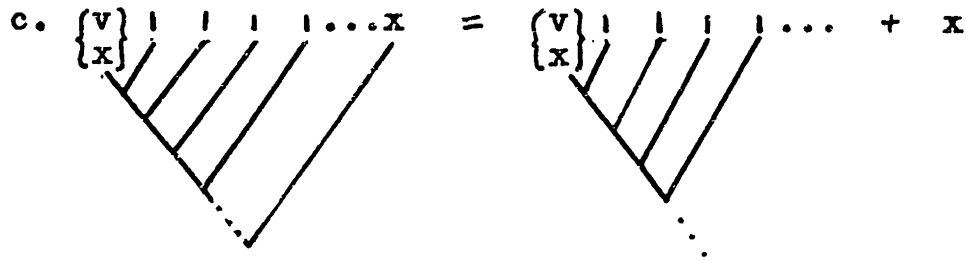

There are other common characteristics, too: for example, the feet with free final nodes appear never to be assigned iteratively, but only at the right or left edge of a word. (The one putative exception to this generalization is dealt with later in this chapter.) Furthermore, the feet are oriented at the word edge so that the free final node dominates the final or initial syllable. All these observations conspire to suggest that Halle's augmented feet having free final nodes are simply the ordinary feet of the more restricted inventory applied in a way such that a word terminal syllable has been skipped over. To give an example, the initial stages in a Latin stress derivation should appear as in (10):

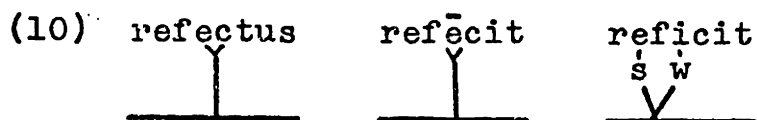

in which ordinary binary quantity sensitive feet have been assigned, rather than as in (11):

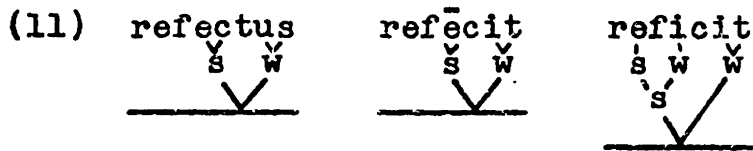

as Halle would suggest. An encouraging clue that this is the right approach is provided by the placement of secondary stress in Winnebago, which, it will be recalled, has third syllable main stress. The secondary stresses in Winnebago fall on every second syllable after the main stress, rather than on every third syllable. This supports the idea that the initial foot is constructed as binary, skipping over the initial syllable, since in this way the construction of all the Winnebago feet can be formulated as a single rule, constructing binary, quantity insensitive feet with right nodes dominant from left to right:

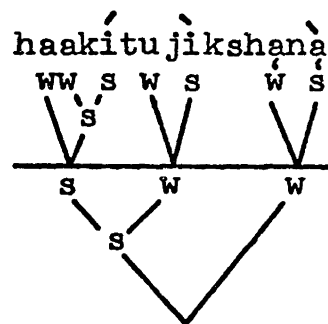
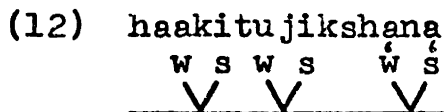

"I pull it taut-declarative"

The formal device that is needed to allow word terminal syllables to be skipped over has in fact already been proposed

in the literature: Liberman and Prince (1977) and Nanni (1977) suggest that certain syllables may be extrametrical, or temporarily excluded from consideration by the stress rules. Liberman and Prince and Nanni use extrametricality to account for certain irregularities in the labeling of word trees in English. Here it will be extended to account for the construction of the feet. Let us define the marker [+extrametrical] as a diacritic feature attached to rimes which causes stress rules to treat a rime as if it wasn't there. In other words, [+extrametrical] rimes are skipped over in foot construction, and feet which branch into an extrametrical rime plus another terminal constituent are counted as non-branching. The claim made here is that extrametrical rimes may be found only at the edges of a stress domain; i.e. at word edges in languages with word stress and phrase edges in languages with phrasal stress. We can tentatively formulate the rule schema for extrametricality assignment as follows:

$$(13) R \rightarrow [+ex] / \left\{ \begin{array}{l} \text{---} \\ \text{[---]} \end{array} \right\}$$

An extrametricality rule causes the immediately following rule to ignore the rime marked [+ex]. In Latin, for instance, the extrametricality rule has the form

$$(14) R \rightarrow [+ex] / \text{---}]_{\text{word}}$$

We will use parentheses to indicate that a rime has been marked as extrametrical. The application of (14) to the forms of (11) will thus result in the following representations on the rime projection:

$$(15) \text{a. } \begin{array}{c} e \text{ ec (us)} \\ | \quad \vee \quad \vee \\ R \quad R \quad R \end{array} \quad \text{b. } \begin{array}{c} e \text{ ee (it)} \\ | \quad \vee \quad \vee \\ R \quad R \quad R \end{array} \quad \text{c. } \begin{array}{c} e \text{ i (it)} \\ | \quad | \quad \vee \\ R \quad R \quad R \end{array}$$

Using our customary representations, in which the rime projection is not made explicit, we will place parentheses around an entire syllable to indicate that its rime is extrametrical. The representations of (15) are thus the equivalent of those of (16):

$$(16) \text{a. } \text{refec(tus)} \quad \text{b. } \text{refee(cit)} \quad \text{c. } \text{refi(cit)}$$

The metrical rule that applies to the representations of (16) constructs a binary, left dominant foot at the right edge of a word. Because the word final rime is extrametrical, however, the foot is actually constructed starting at the second rime from the right, as in (17):

$$(17) \text{a. } \begin{array}{c} \text{refec(tus)} \\ | \\ \text{-----} \end{array} \quad \text{b. } \begin{array}{c} \text{refee(cit)} \\ | \\ \text{-----} \end{array} \quad \text{c. } \begin{array}{c} \text{refi(cit)} \\ \begin{array}{c} \text{s} \quad \text{w} \\ \vee \\ \text{-----} \end{array} \end{array}$$

Once an extrametrical syllable has been skipped over by a stress rule, it must be joined to the tree in order to

receive a prominence interpretation. This can be done by a universal convention, formulated as in (18):

(18) Stray Syllable Adjunction

Adjoin a stray rime as a weak member of an adjacent foot.

(18) will require some modification later, but is adequate to handle the cases presented so far. I assume that (18) is a universal convention rather than a phonological rule: it applies whenever its structural description is met, once the foot construction rules have applied. The possibility of reapplying Stray Syllable Adjunction several times in a derivation will later be seen to be important in the stress analyses of Tiberian Hebrew and English.

The need for a Stray Syllable Adjunction convention can be established independently of its role in adjoining extrametrical syllables, since segmental rules often introduce new syllables into a derivation after the stress rules have applied. These almost always receive no stress, a pattern which is predictable by the convention (18). One example is provided by a vowel copying rule in Macassarese (van der Tuuk 1971), which takes the form (19):

$$(19) \quad v \begin{pmatrix} l \\ r \\ s \end{pmatrix} \# \rightarrow v \begin{pmatrix} l \\ r \\ s \end{pmatrix} v ? \#$$

1 2 3 1 2 1 3

Words which undergo (19) have antepenultimate stress, while the remainder of the Macassarese vocabulary exhibits penultimate stress. This will follow if we assume that stress is derived by the construction of a binary, quantity insensitive, left dominant foot at the right edge of the word, before rule (19) applies. After the application of (19), the resulting stray syllables are adjoined by Stray Syllable Adjunction as weak members of the preceding foot, resulting in antepenultimate stress. English also has syllables that are introduced by phonological rules, such as Sonorant Syllabification (Liberman and Prince 1977, p. 297), and a rule discussed in Chapter 5. These can also be joined to the tree in the proper way by Stray Syllable Adjunction. In addition, the convention can also properly attach syllables created by Dorsey's Law in Winnebago, discussed in Halle and White Eagle (1979).³

Returning now to the Latin derivations of (17), we can derive the correct surface forms by means of Stray Syllable Adjunction and the construction of a right dominant word tree:

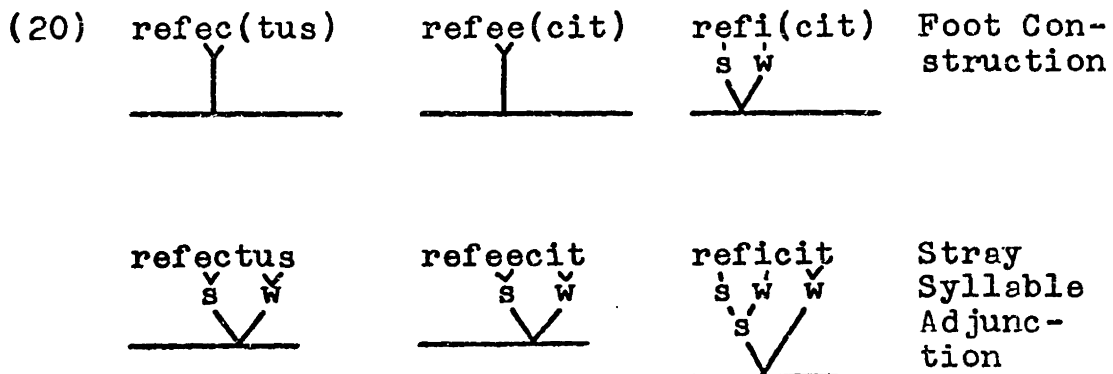

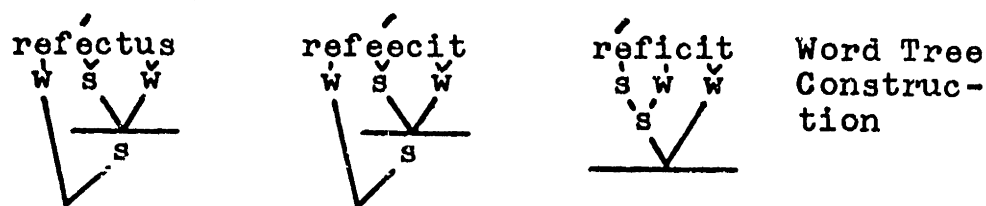

Similar analyses apply to languages like Classical Arabic and Winnebago: the foot found on the surface having a free extrametrical node is derived by marking a word terminal rime as extrametrical, forming a foot from the standard inventory, then applying Stray Syllable Adjunction.

Let us now examine how the extrametricality theory avoids some of the disadvantages incurred by expanding the foot inventory. First, we have an explanation for why feet which have the surface forms of (21):

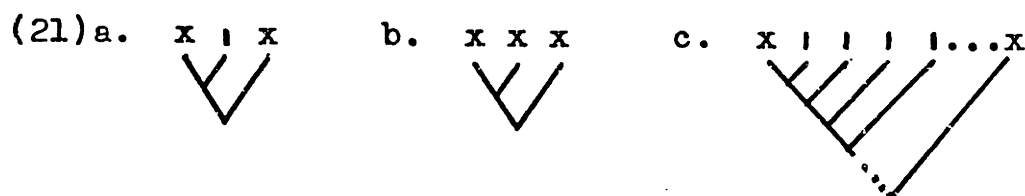

are never assigned iteratively, since under the new theory their final nodes form part of the foot only because the rimes they dominate were earlier marked for extrametricality, which may only happen at word edges. In addition, we have accounted for why all Winnebago feet that are assigned in other than initial position are binary, rather than ternary, since only the leftmost one can be derived using extrametricality. Finally, we avoid having to postulate unmarked feet that are either extremely rare or unattested, in order to impart

symmetry to an expanded foot inventory.

There are also some positive arguments supporting the extrametricality analysis. Consider, for example, the stress pattern of Mountain Cheremis (Ramstedt 1902). In this language, stress is based on the distinction between the full vowels [i, e, a, ä, o, u, ö, ü] and the reduced vowels, which I will denote as [ɛ] and [ʌ]. As the full vowels are phonetically longer than the reduced vowels, I will assume that they are represented underlyingly as geminates, so that the appropriate distinction for the stress rules can be represented as that of branching vs. non-branching nodes on the [+syl] projection, as in Eastern Cheremis. The stressing of single words of Mountain Cheremis is quite similar to that of Classical Arabic: stress falls on the last full vowel of the word that isn't in final position:

(22)	aapáaxaa	"pod"
	aayarteémɛn	"especially"
	lʌštáarʌktaaš	"cause to weaken"
	kään'ɛsɛr	"sorrow"
	aáyʌrʌktaaš	"to let free"
	βʌlaaraáneštɛšɛ	"comedian"

I assume, then, that stress is assigned to these words in the same way as in Classical Arabic: first, the rightmost rime is marked as extrametrical, then a left dominant foot is constructed on the [+syl] projection at the right edge of the word. Stray Syllable Adjunction then applies, and a

right dominant word tree is constructed:

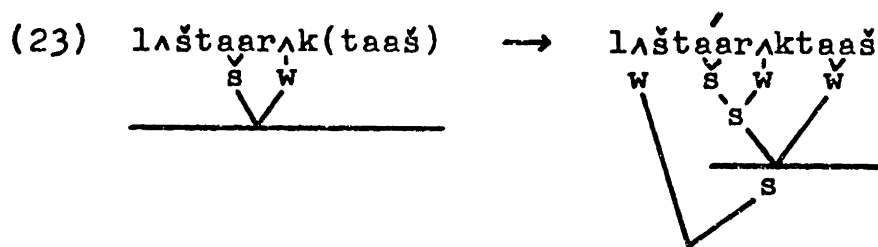

When all the non-final vowels of a word are reduced, the stressing is not as regular; we find:

(24)	$y\acute{e}p\acute{e}\check{z}\check{a}\check{a}$	"friendly"
	$\epsilon p\acute{e}r\check{a}\check{a}$	"maggot, moth"
	$p\acute{a}\check{s}\lambda r\check{s}\lambda\check{s}\lambda$	"brittle"
	$s\epsilon m\acute{e}r\epsilon k\check{t}\check{a}\check{a}\check{s}$	"cause to overthrow"
	$ts\epsilon t\epsilon r\acute{e}k\check{t}\check{a}\check{a}\check{s}$	"cause to tremble"

I will assume that in such words, one of the reduced vowels is marked with the diacritic [+H] so that it will occur as the dominant terminal node of a foot. Other analyses may be possible, but nothing in what follows depends on this.

The interest of the Mountain Cheremis data lies in the stress shifts that are found in compounds and certain close-knit syntactic phrases. In such groupings, the second element is stressed in the ordinary way; but stress in the first element falls on the last full vowel--even if the vowel is in word final position:

(25)a.	$ka\acute{a}r\acute{e}em$	"hilly riverbank"
	$ooli\acute{i}ts\check{a}\check{a}$	"street"
	$ka\acute{a}r\acute{e}em-$ $ooli\acute{i}ts\check{a}\check{a}$	"street leading to a riverbank"

- b. $\text{saa}^{\prime}\text{raa}$ "smallpox"
 $\text{βaa}^{\prime}\text{saa}^{\prime}\text{alkaa}$ "residue"
 $\text{saa}^{\prime}\text{raa-}$
 $\text{βaasaa}^{\prime}\text{alkaa}$ "pock marks"
- c. $\text{βoo}^{\prime}\text{č}^{\prime}\text{raa}^{\prime}\text{č}$ "shoulder ornament of a woman's blouse"
 $\text{kaa}^{\prime}\text{l}^{\prime}\text{aakaa}$ "bent"
 $\text{βoo}^{\prime}\text{č}^{\prime}\text{raa}^{\prime}\text{č-}$
 $\text{kaa}^{\prime}\text{l}^{\prime}\text{aakaa}$ "end of shoulder ornament"
- d. $\text{βu}^{\prime}\text{usa}$ "thin"
 $\text{p}^{\prime}\text{ertse}$ "grain"
 $\text{βu}^{\prime}\text{usa-β}^{\prime}\text{ertse}$ "meager, dried out grain"

These stress shifts have a very simple and natural interpretation under a theory using extrametricality: we need only assume that the domain of the foot construction rule is the simple word, whereas the domain of the rule marking the rightmost syllable as extrametrical includes compounds and the relevant set of close-knit syntactic phrases. The derivations will go as in (26):

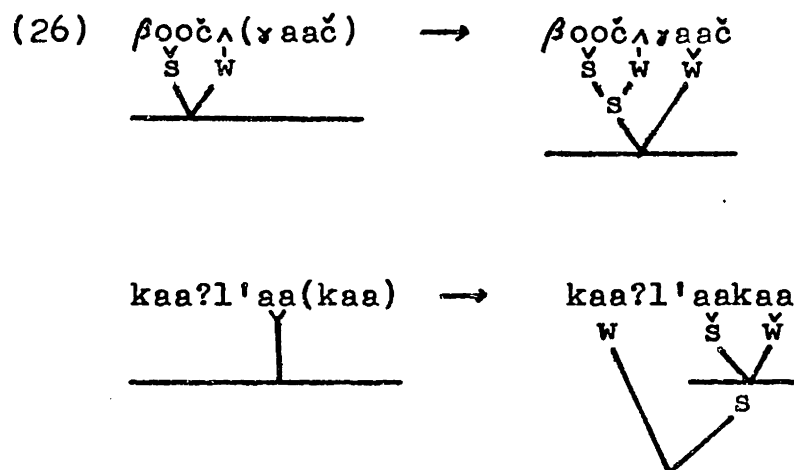

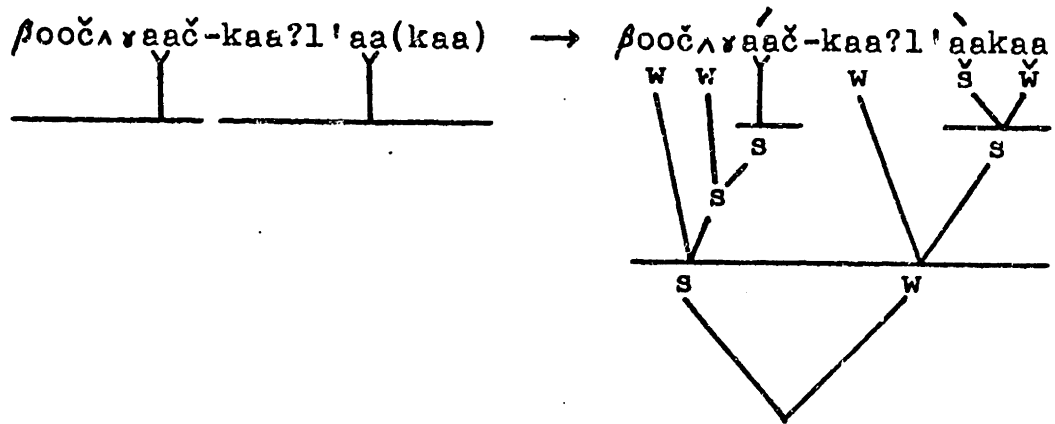

Thus in Mountain Cheremis, the extrametricality rule can be shown to be an entity independent of foot construction, as it applies in a different domain.

The Hopi language, as discussed in Jeanne (1978), provides a different sort of argument for extrametricality. Stress in Hopi is manifested as high tone, which the stress rule must associate with short vowels and with both of the underlying "halves" of a long vowel, i.e. $\acute{V}\acute{V}$ (Ken Hale, personal communication). On the surface one also finds long vowels with falling tone, i.e. $\acute{V}\check{V}$. However, Jeanne demonstrates that these are derived from $\acute{V}?$ by a rule applying after stress assignment, which replaces the glottal stop with a low pitched vowel identical in quality to its left neighbor. The Hopi rules may thus be regarded as rules of stress placement, with the tonal realization of stress implemented by other rules. This is in fact the approach taken by Jeanne.

The basic stress pattern of Hopi is a natural one under our framework: stress falls on the initial syllable if it is heavy, and the second syllable if the initial syllable is light:

- (27)a. táávo "cottontail"
 náátihota "to hurt oneself"
 pááwik^ya "duck"
- b. ?ácvewa "chair"
 léstavi "roof beam"
 cáyhoya "child (diminutive)"
- c. qötósompi "headband"
 caqápta "disk"
 melóóni "melon"

The metrical rules would be:

- (28)a. At the left edge of a word, form a binary, right dominant foot on the rime projection.
- b. Form a left dominant word tree.

The tone assignment rule is then formulated to assign high tone to the strongest syllable of a word.

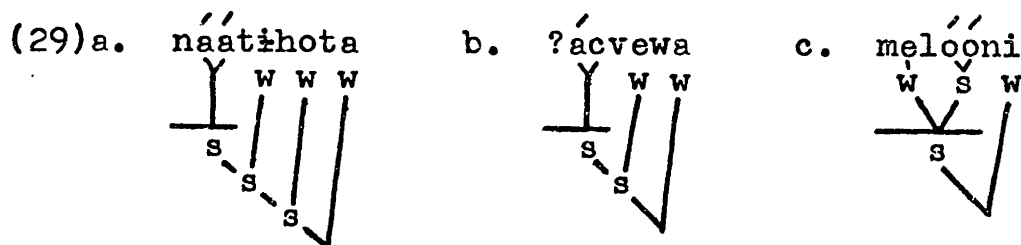

This works nicely, but there is a glitch that must be accounted for: bisyllabic words always receive initial stress, even if their first syllable is light:

- (30) kóho "wood"

wári	"to run"
láho	"bucket"

The problem can be resolved simply by marking final syllables as extrametrical, as in (31):

(31)	ko(ho)	qötösom(pi)	R → [+ex]/____]word
	ko(ho)	qötösom(pi)	Foot Construction
	kóho	---	Stray Syllable Adjunction
	---	qötösompi	Word Tree Construction

We thus have another case in which extrametricality is necessary for a descriptive purpose other than accounting for feet outside of the unmarked foot inventory. Hopi is not the only case of its type, as other languages have similar stress placement. For instance, Rora (Strong 1913-14) has the same stress pattern as Hopi, except that only syllables with long vowels, rather than all syllables with branching rimes, are counted as prominent. Sierra Miwok (Freeland 1951) also displays a pattern like that of Hopi, although the facts are made more complicated by a rule of detressing--for discussion see Hayes (1979b). Finally, the absence of stress on final vowels in Southern Paiute (see above, pp. 89-90) can be

accounted for by marking final rimes as extrametrical.

One question I haven't addressed is how monosyllables are to be stressed in languages that mark rimes as extrametrical. The most intuitively plausible answer would be to say that monosyllables receive stress simply because they are the strongest (albeit only) element of their word tree. This would require that segmental rules which are sensitive to foot boundaries, such as the cases discussed in Kiparsky (1979), must be sensitive to word tree boundaries as well, as a default case. Whether this solution is empirically adequate must await future investigation.

6. Other Kinds of Extrametricality

Mohanan (oral presentation, 5/79) describes the stress facts of Hindi in the following way. Categorizing the Hindi rimes as light (V), heavy (VC, VV), and superheavy (VVC, VCC), he states the pattern as in (1):

- (1)a. Stress a final superheavy syllable.
- b. Otherwise stress the rightmost non-final heavy syllable.
- c. Otherwise stress the initial syllable.

Some examples are

- (2)a. kama^áal "wonders"
- raaji^ív "lotus"
- b. ra^ájan (proper name)
- insa^áaniyat "humanness"

	kéésariyaa	"saffron colored"
c.	kámal	"lotus"
	páricitaa	"female acquaintance"
	ánumati	"permission"

The basic pattern seems to be one of stressing the rightmost heavy syllable, but with a different definition of "heavy" for final syllables: VVC and VCC are opposed to lighter rimes, rather than branching rimes being opposed to non-branching ones. Two proposals have been made in the literature to handle this phenomenon. McCarthy (1979a,b) deals with similar facts in Classical Arabic and other Arabic dialects. In the case of Classical Arabic, we find that the superheavy syllables (CVVC and CVCC) differ from all other syllables in receiving stress in final position. McCarthy observes that only word final syllables in Classical Arabic may be superheavy, whereas all the other syllables must have one of the forms CV, CVC, or CVV. This suggests that the canonical rime template in Arabic allows for only two segments at most, and that the final C of a superheavy syllable is only later adjoined to the preceding, properly syllabified segments. If this is so, McCarthy points out, we can profitably regard the superheavy syllables as containing two rimes, an ordinary one plus a degenerate one consisting of a single consonant. Under this proposal, final superheavy syllables will receive stress just as heavy penults do, since the rime structures are equivalent after the final rime has

rule is needed to attach the extrametrical segments to their preceding rimes: they are already attached. The extrametricality rule simply specifies that they are to be ignored for purposes of tree construction. The analysis using segment extrametricality can also handle the facts of Classical Arabic, since its stress pattern is the same as that of Hindi.

Which of these two proposals is correct? The right answer may be both. ^eStriade (1980), in her detailed discussion of Ancient Greek accent, suggests that Greek must have a rule making final consonants extrametrical in order to assign accent within words, but that /s/'s occurring in #sC and Cs# clusters must be counted as separate rimes in order to account for the clitic accent pattern. This treatment of /s/ is a natural one, since CsC clusters don't occur word internally.

Another example of segment extrametricality is found in Meadow Cheremis (Levy 1922). This dialect shares the normal Cheremis stress pattern of stressing the rightmost non-reduced vowel, as (5) shows:⁴

- | | | | | | |
|-------|----------|----|-------------|----|----------|
| (5)a. | pvrǵüü | b. | jaamtə | c. | jooǵələš |
| | iizii | | jaášmər | | luuškədə |
| | eerlaá | | kaantaáanəs | | óoməžə |
| | laateéš | | | | |
| | d'üüleér | | | | |

However, lax mid vowels in absolute final position may also be skipped over, as in (6):

- (6) $\acute{k}e\acute{e}lgy\acute{\epsilon}\acute{\epsilon}$ $\acute{\epsilon}\acute{\epsilon}g\acute{\epsilon}\acute{\epsilon}l\acute{\epsilon}\acute{\epsilon}$ $\acute{n}\acute{a}ar\acute{o}n\acute{c}\acute{\epsilon}\acute{\epsilon}$
 $\acute{n}\acute{o}\acute{o}\acute{c}k\acute{o}\acute{o}$ $\acute{d}\acute{u}\acute{u}m\acute{o}\acute{o}$ $\acute{w}\acute{o}l\acute{g}\acute{o}n\acute{c}\acute{\epsilon}\acute{\epsilon}$

The requirement that the lax mid vowels be in absolute final position is illustrated by the contrast between $\acute{k}e\acute{e}lgy\acute{\epsilon}\acute{\epsilon}$ and $la\acute{a}t\acute{\epsilon}\acute{\epsilon}\acute{s}$. The word $\acute{\epsilon}\acute{\epsilon}g\acute{\epsilon}\acute{\epsilon}l\acute{\epsilon}\acute{\epsilon}$ also points this out: the rightmost / $\acute{\epsilon}\acute{\epsilon}$ / may be skipped over, as it is in word final position, but the / $\acute{\epsilon}\acute{\epsilon}$ /preceding it may not. These facts suggest that in Meadow Cheremis, lax mid vowels (or more precisely, the second "halves" of them) are marked as extrametrical in the environment /_____] word. The stress pattern may then be derived by the construction of a left dominant foot and a right dominant word tree, as in Eastern Cheremis:

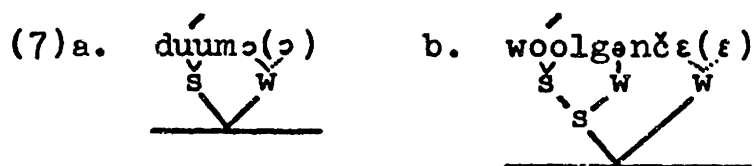

I could find no examples in Levy's grammar of words consisting solely of reduced vowels. However, examples like $k\acute{a}n'\acute{\epsilon}\acute{\epsilon}$, $l\acute{a}b\acute{a}rg\acute{\epsilon}\acute{\epsilon}$, $t\acute{a}g\acute{a}d\acute{\epsilon}\acute{\epsilon}$ and $k\acute{a}st\acute{a}l\acute{g}\acute{o}\acute{o}$ suggest that Meadow Cheremis differs from Eastern Cheremis in that it requires dominant nodes in the foot to branch--these examples would accordingly have no foot erected over them, but would be given final stress by the word tree.

We have now presented or cited evidence for making rimes, segments, consonants, and certain vowels extrametrical. The

question naturally arises of whether the theory has been fatally weakened by these new devices: could not a clever use of extrametricality allow us to express unattested stress rules that the system is designed to exclude? I believe the answer is no, because extrametricality rules may be constrained in two crucial ways. As we have already seen, extrametricality may be assigned only at the edge of the stress domain. In addition, it appears that only constituents need ever be marked as extrametrical, and that extrametricality rules needn't ever refer to the internal structure of the constituent being marked, other than its feature specifications. Because of this, it would be impossible for an extrametricality rule to refer to syllable quantity. I believe these restrictions are sufficient to preserve the predictive power of the theory, although their empirical validity must be checked by future research.

7. Stress in Tiberian Hebrew

A potential counterexample to the claims made here lies in McCarthy's (1979a) ingenious and valuable study of stress in Tiberian Hebrew, the language of the Old Testament as it was phonetically annotated at Tiberias in about the sixth century A.D. I will devote a fair amount of space here to a reanalysis of McCarthy's data with two purposes in mind. First, the reanalysis will support the metrical framework proposed here insofar as remaining within the framework results in a more satisfactory account of the facts. Second, the reanalysis makes interesting claims about the nature of

Stray Syllable Adjunction, which will have important consequences for the analysis of English stress in Chapter 5.

We will begin with the problems of Hebrew syllable structure. Hebrew syllables come in three varieties, which may be classified in the same way as the syllables of Arabic: light (CV), heavy (CVC, CVV), and superheavy (CVCC, CVVC). Just as in Arabic, the superheavy syllables occur underlyingly only word finally, and are assigned by McCarthy a structure with two rimes (VC or VV, plus C), which we will adopt here unchanged. McCarthy parses the remaining syllables as in (1):

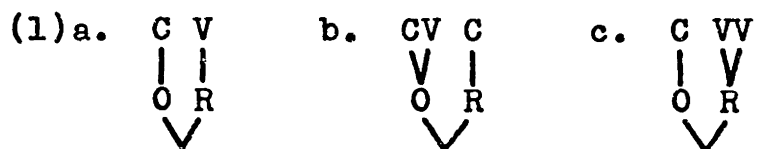

The odd man out in (1) is b, where the vowel is grouped with the initial consonant in the onset. Since (1)b violates what is a good candidate for a linguistic universal (that the sonority peak of the syllable always falls within the rime), it is a relief to find that this structure is by no means crucial in any of the phonological rules that McCarthy proposes: its main purpose is to express the prominence distinction between long and short vowels as that of branching vs. non-branching rimes. As we have seen, this can be done using more normal syllable structures by having the relevant rules apply on the projection [+syl]. There in fact is good evidence that the syllable structure of CVC

must be C VC, since there are two rules in Hebrew that refer



to the more conventional notion of branching rime, which opposes CVV and CVC to CV. These rules are Pretonic Lengthening, which lengthens /e/ before the main stress only when a light (CV) syllable precedes it, and Vowel Reduction (McCarthy p. 51), which is discussed below. McCarthy must state these rules in a rather complex way in order to fit them into his theory of syllable structure, even though the distinction they refer to is a widespread and highly natural one. We will therefore assume that the syllable structures of Hebrew are as in (2):

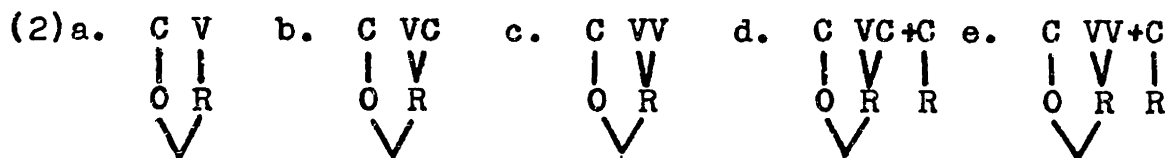

and that rules based on the distinction of vowel length apply on the [+syll] projection.

Main stress assignment in Hebrew as McCarthy describes it is somewhat marked, although expressible in the formalism presented here: at the earliest level of representation, main stress is assigned to the final syllable of a word if it is closed, otherwise to the penult. This can be expressed under our theory by the construction of a binary, left dominant

foot at the right edge of the word. The rule must apply on the rime projection, with the stipulation that nodes dominating long vowels are not counted as branching. (Perhaps this is due to the presence of a nucleus node in Hebrew syllables --see Section 2 above.) Some examples are

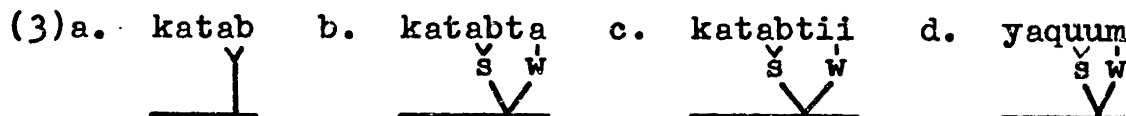

In the transcriptions, I have ignored the effects of a rule of Spirantization (McCarthy 1979a, pp. 64-67), which will not be relevant here. Observe that in yaquum the foot that has been constructed is binary, dominating the two rimes of the syllable quum. It should be noted that McCarthy's analysis of main stress, which assumes that a rime is prominent if it ends in a consonant, will place stress on the final consonant of yaquum. It thus requires an adjustment rule to avoid a phonetic absurdity which isn't encountered under the new system.

The feet constructed in (3) are incorporated into right dominant word trees, as in (4):

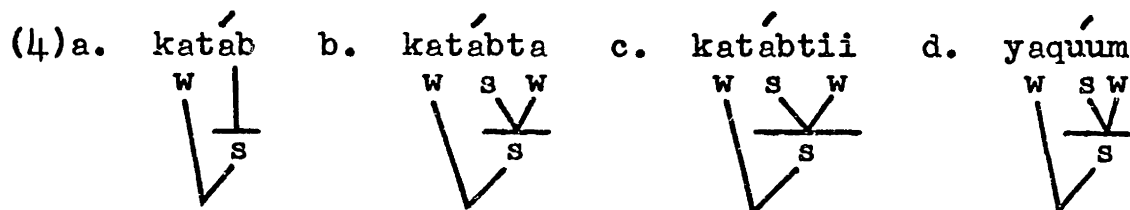

After a number of segmental rules apply, we encounter the rule of Vowel Reduction. This rule reduces the vowel of a light (CV) syllable whenever it immediately precedes, or is separated by an even number of CV syllables from, a heavy syllable. McCarthy formulates this as a metrical rule: in our terms we form binary, right dominant feet (which McCarthy calls ρ structures), going from right to left on the rime projection. Vowels that are in a weak position in a foot then reduce, and in many cases later delete:

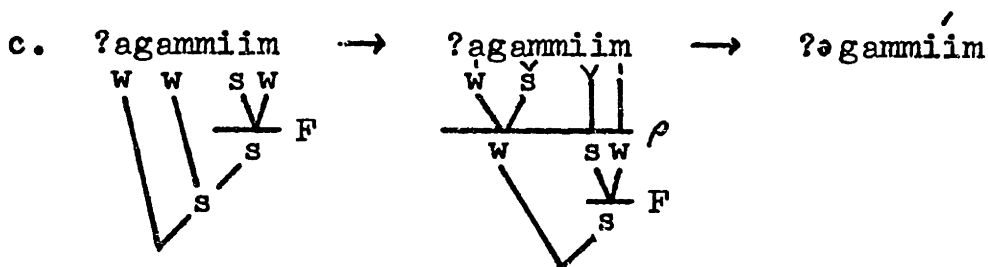
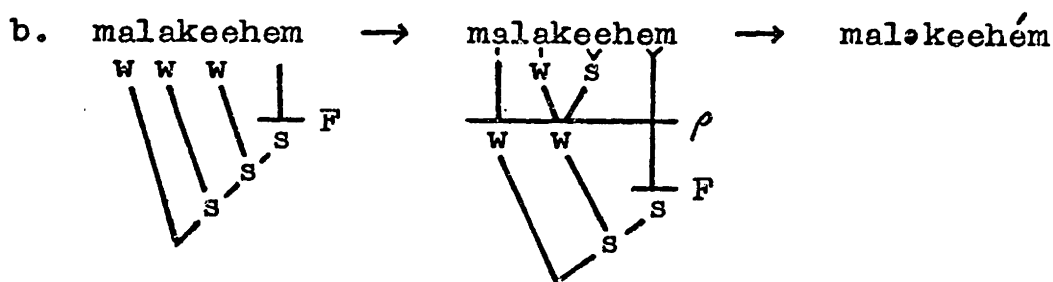
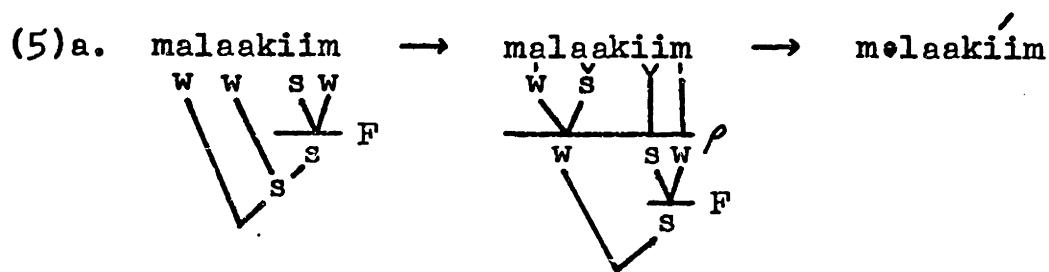

Notice how the ρ structures are integrated into the structure already created: they are placed underneath it (above it, in our inverted diagrams) forming a new level of structure, with the structure of the higher levels preserved as

much as possible. McCarthy does not label the separate levels of structure, but this seems to be a fair interpretation of his claims. The most interesting aspect of Vowel Reduction is its ability to apply to the main stressed vowel if the segmental conditions are met:

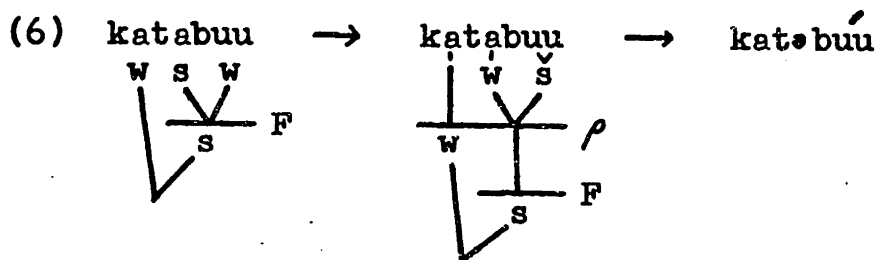

In such cases, the stress shifts to the final syllable. As can be seen, this is an automatic consequence of McCarthy's formal apparatus.

It turns out that the trees assigned by the rules so far must be modified to account for the placement of secondary stress and for certain stress shifts. An example of the latter is a Rhythm Rule (McCarthy, p. 158), which moves the main stress to the left under the following conditions:

(a) The syllable off of which stress is retracted is word final, and not superheavy; (b) The syllable onto which stress is retracted must have a long vowel, and must be the closest such syllable; (c) The following word has initial main stress; (d) The two words must occur in a certain syntactic context. If these conditions are not met, the stress stays where it is, or is removed by another rule.

McCarthy suggests that the Rhythm Rule be formulated as a rule labeling the branches of a new metrical structure, which

is left branching, unbounded, and sensitive to the distinction between long and short vowels. The terminal dominant nodes of the structure must branch, and the only recessive node which may branch is the rightmost. This pattern is summarized as (7):

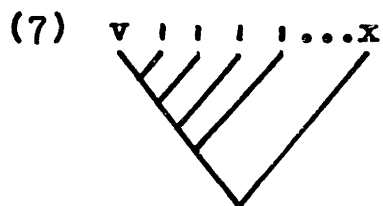

The Rhythm Rule has the effect of labeling this foot so that dominant nodes are strong. Some examples are the following:

(8)a. qaaraá laáylaa → qaaraa laáylaa

b. tee9aazáb ?áares → tee9aazab ?áares

c. taamnuú líi → taamnuu líi

d. ?arzee ?eél → ?arzee ?eél

e. laasuúd sáyid → laasuúd sáyid

f. læsaheq bóo → læsaheq bóo

In gaaraa, tee9aazab, and taamnuu, the stress shifts off of the final syllable because the foot is polysyllabic. In ?arzee, the only foot that may be constructed keeps the stress on the final syllable. The same is true of laasuud: notice that the behavior of this word with respect to the Rhythm Rule supports McCarthy's claim that its final syllable contains two rimes. If it had just one rime, then the Rhythm Rule would be free to retract stress off of it, in the same way as in tee9a'azab ?a'ares. Finally, it can be seen that in lo.sah'eq, no foot is constructed, because there is no branching node in the word. The stress accordingly remains in final position.

How does the foot constructed by the Rhythm Rule fit in- to the metrical structure created by earlier rules? The simplest answer would be to say that the Rhythm Rule foot is only constructed when the proper context for the rule is met, i.e. when there is a following initial stressed word in the proper syntactic environment. If the Rhythm Rule applies, the old structure that dominates material covered by the new foot deletes, but otherwise would remain intact. McCarthy suggests, however, that the new feet of the Rhythm Rule must always be constructed, and that the old prominence relations of the syllables are maintained by labeling the new feet in the appropriate way. We can thus speak of Foot Construction and the Rhythm Rule as separate rules: Foot Construction interprets the prominence relations of the old tree using a new bracketing, and the Rhythm Rule simply

relabels the last foot of the word, as in (9):

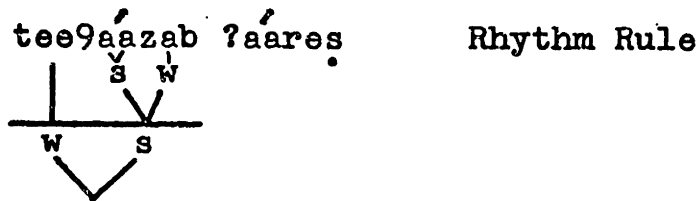
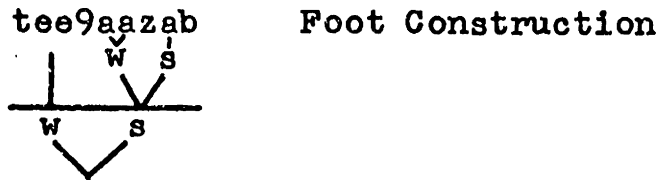
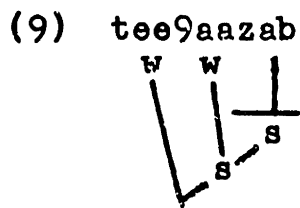

The reason behind McCarthy's proposal is that under his analysis, three other rules are sensitive to the same foot structure, none of which is restricted to applying within the context necessary to the Rhythm Rule. For the moment, we will confine our attention to the rule that assigns secondary stresses. The basic facts of secondary stress in Hebrew are as follows: secondary stress is assigned iteratively, falling on the second syllable to the left of the main stress or a previously assigned secondary stress, provided that this syllable has a long vowel. If its vowel is short, secondary stress falls on the closest syllable to the left that does have a long vowel. If there is no such syllable, no (further) secondary stress is assigned. Some examples are as in (10):

(10) mēhaššitṭiim
tēḡaazáb

hàaḡásriiḡeeli
mēhattaḡtoonót

baariišoonáá

Under McCarthy's analysis, the secondary stresses result from the iterative construction from right to left of feet identical to those used in the Rhythm Rule. Some examples should make it clear how this works. The derivation of mehaššittim, as follows, is straightforward:

(11) mehaššittim

early rules

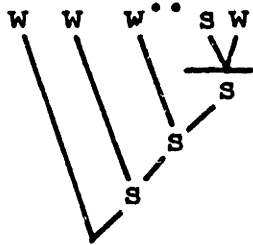

mehaššittim

reformation into feet

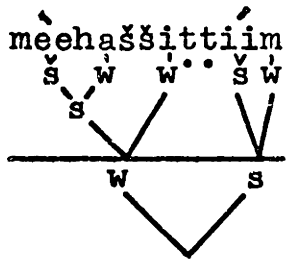

The stressing of tē9aazáb requires that the final syllable retain the strong label that it had in the earlier structure:

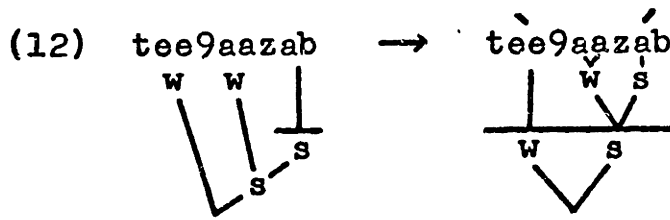

The stressing of baariišoonáá:

McCarthy's ingenious analysis of secondary stress would appear to justify the claim that the entire word is re-analyzed into feet of the type assigned by the Rhythm Rule. It is also a serious counterexample to the proposals of this chapter: we have tried to restrict the inventory of unmarked feet so as to exclude feet of the form (21):

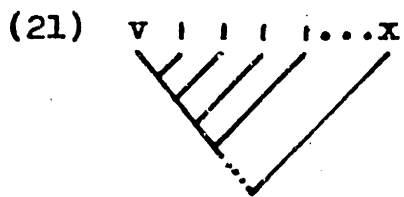

except in word terminal position, where they can be constructed with the aid of extrametricality. In order to allow for McCarthy's trees, we would have to permit rimes to be marked [+ex] in word medial position before another foot, by a rule that alternated in its application with the various iterations of the foot construction rule. Such an analysis would be undesirable because of the otherwise unattested ordering principle it would require, and because it would eliminate much of the predictive power of the extrametricality theory, reducing it to a notational variant of Halle's. It is a good idea, then, to try to find holes in McCarthy's analysis, and to propose an alternative that stays within the limits of the general theory.

One serious question about McCarthy's analysis arises from his claim that when the metrical trees created earlier in the derivation are converted into foot based trees, the relative prominence relations may be carried over through

the labeling, as in (22):

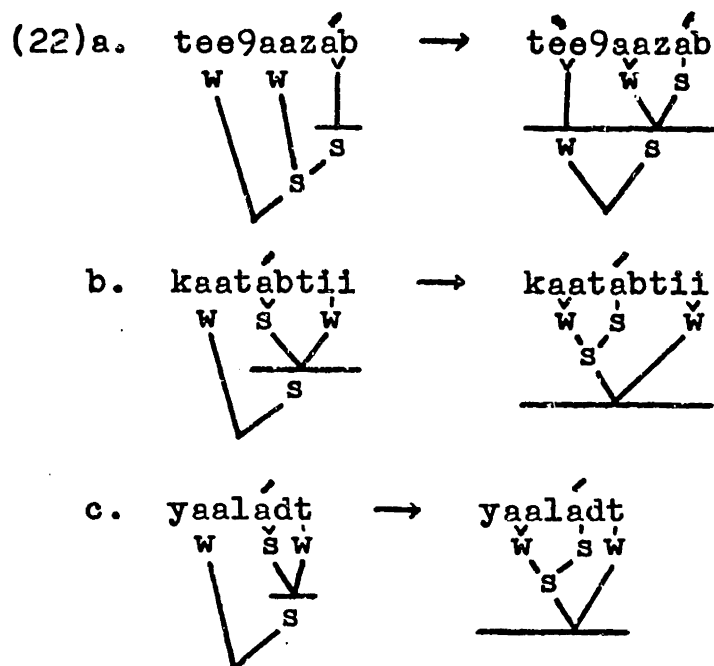

For example, in the output tree for tee⁹aazab, the labeling convention for feet would normally label the rightmost foot *s w*, since the final syllable dominates a short vowel. McCarthy claims (p. 157) that the actual labeling of the final syllable as strong results from its having been labeled strong in previously created metrical structures. It is not clear what McCarthy means here: if the construction of the new foot wipes out previously assigned structure, then what McCarthy proposes must be a global rule, since it must refer to information that is available only at an earlier stage of the derivation. I assume that such rules must be excluded a priori owing to the weakening of phonological theory they involve. Suppose instead that foot construction erects a new structure in parallel with the old one, with the stipulation that surface prominence relations are read off of the

structure that was more recently assigned. Such a theory would not involve global rules, but the labeling procedure for the new tree would be complicated. For example, in (22)b the syllable tab in the derived tree is marked as relatively strong with respect to the syllable kaa (violating the ordinary labeling rule) presumably because in the underlying tree the constituent tabtii is relatively strong with respect to kaa. Further, the constituent kaatab in the derived tree must be marked as relatively strong with respect to the syllable tii (again violating normal labeling), because in the earlier tree the syllable tab is relatively strong with respect to the syllable tii.

The same problems are found in (22)c. It is not at all clear whether rules of this sort should be allowed in metrical theory--I know of no precedents for them.

One way out for McCarthy would be to say that when earlier metrical structure is deleted, the labels s and w remain attached to the terminal nodes, as in (23):

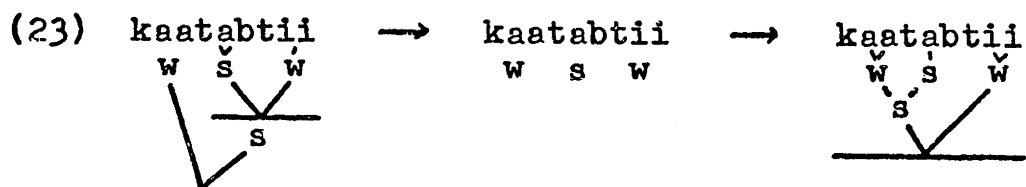

This theory, however, would negate the most valuable claim of metrical theory, which is that stress is a matter of relative prominence-- the labels s and w standing alone in

(23) are clearly notational variants of the old feature values [+stress] and [-stress]. The theory also encounters difficulties when both nodes of a foot have been labeled strong earlier in the derivation. This would happen, for instance, when a stressless penult occurred as the strong element of a ρ structure determining Vowel Reduction, as in (24):

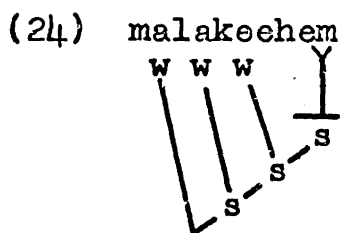

Main Stress Rule

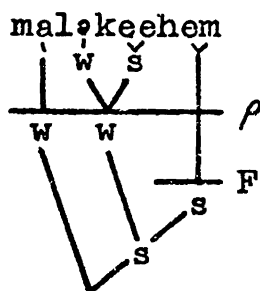

Vowel Reduction

malakeehem
w w s s

deletion of metrical structure

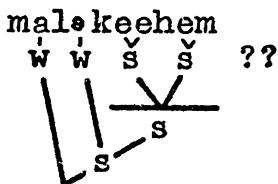

Foot Construction

A binary tree having two strong elements is obviously something that any theory should exclude.

We conclude that McCarthy's theory suffers serious problems in communicating information about relative prominence from old structures to new ones. In searching for a

new theory, a good observation to begin with is that all the rules that refer to McCarthy's unbounded feet (i.e. the Rhythm Rule, secondary stress assignment, and two other rules to be mentioned later) never need to refer to any structure lying to the right of the main stress. This suggests that the correct results might be obtained if we allow the new feet to be constructed only in the part of the word lying to left of the main stress. Retaining the position of the main stress would then be no problem, since the primary stressed rime would head up a foot, equivalent to the newly constructed feet, at the right edge of the word.

How, then, do we allow the feet to be constructed only to the left of the main stress? The best strategy seems to be to delete all of the old metrical structure which is in pre-stress position, then assign feet only where no metrical structure already exists. The deletion rule that is required turns out to be quite simple:

(25) Deforestation

Delete all metrical nodes that are commanded by an s on their right.

The notion of command used here is the ordinary one: we say that A commands B if the node immediately dominating A also dominates B. Some examples of Deforestation are the following:

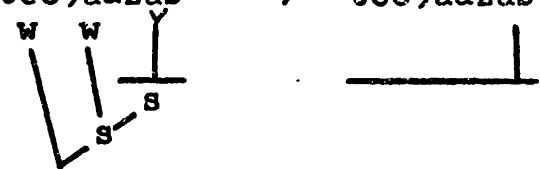
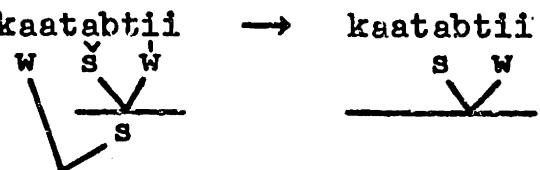
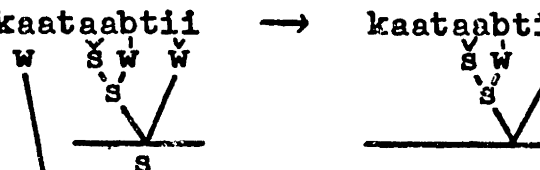
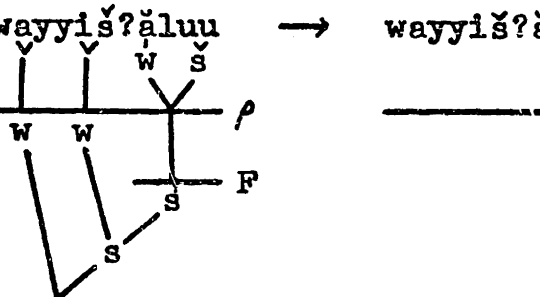
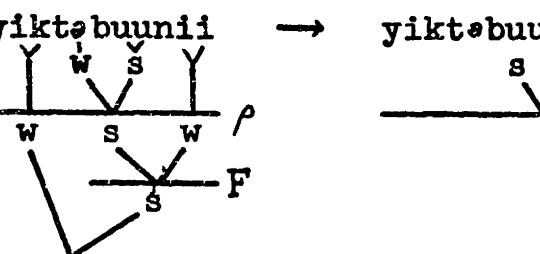
- (26) a. tee⁹aazab → tee⁹aazab

- b. kaatabtii → kaatabtii

- c. kaataabtii → kaataabtii

- d. wayyiš?áluu → wayyiš?áluu

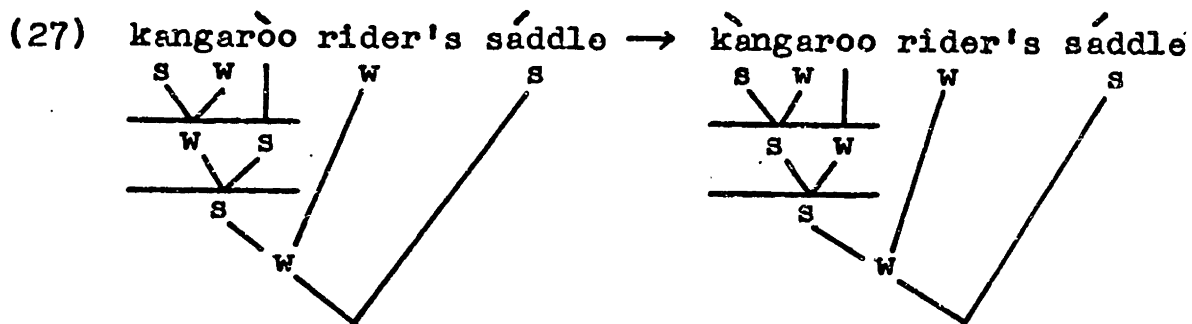
- e. yiktəbuunii → yiktəbuunii

I have assumed some tree pruning in (26)c and e, though nothing crucial depends on this. Deforestation, it can be seen, has the effect of making the strongest element of the tree into the dominant terminal node of a left dominant foot at the right edge of the word.

The use of command in phonological rules has some

good precedents. For example, Kiparsky (1977) shows that command plays an important part in expressing the possible realization of iambic pentameter in English. Similarly, the English Rhythm Rule may be expressed as changing the labeling of two sister nodes from w s to s w when the node which they share is commanded by an s on the right, as in (27):



Once Deforestation has applied, we can erect the rest of the metrical structure using the following rules:

- (28)a. On the projection [+syll], form unbounded left, dominant feet in which dominant nodes must branch.
- b. Form a right dominant word tree.

Some examples are:

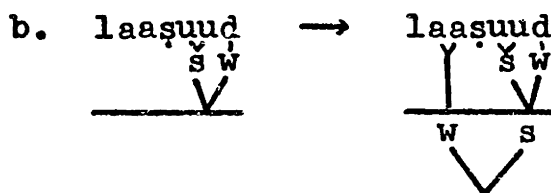
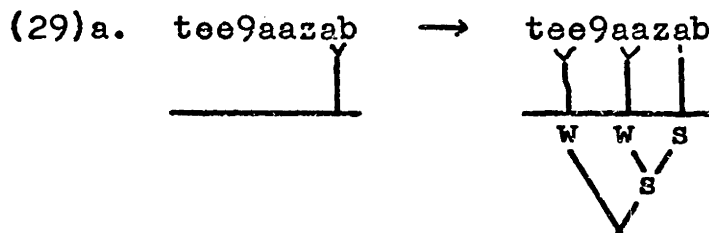

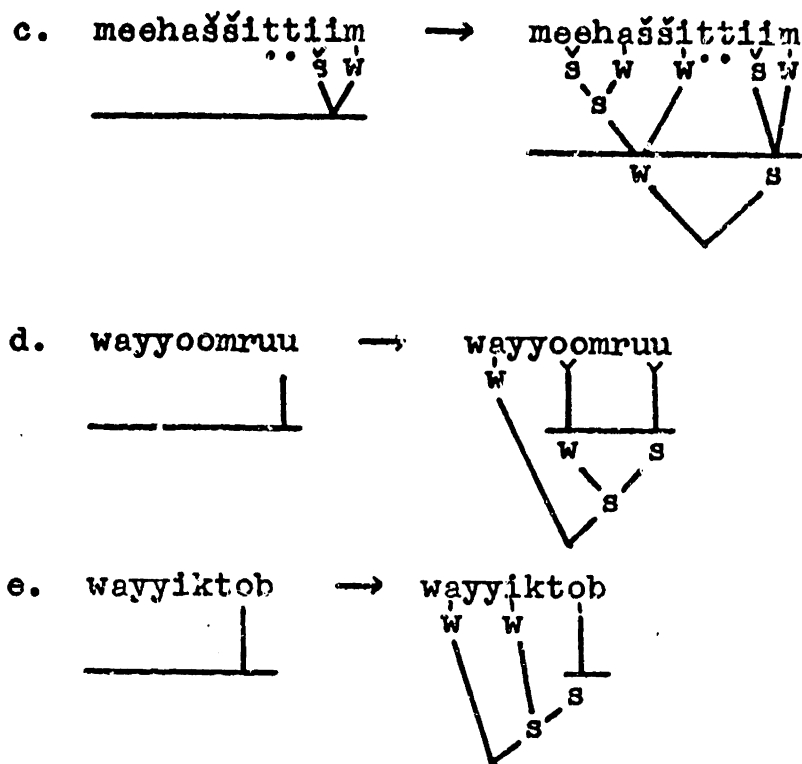

Using these trees, the Rhythm Rule has a new formulation:

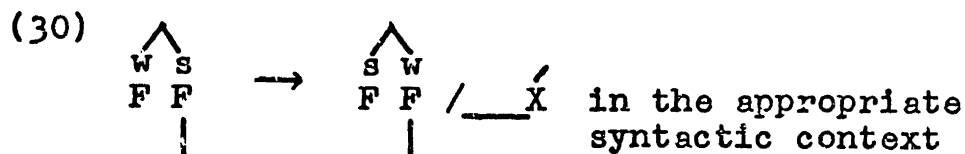

The informal notation used here says to reverse the w s labeling of two sister feet when (a) they occur before a main stress in the appropriate syntactic context; (b) the second of the feet is non-branching; i.e. dominates but one rime. Some examples of the application of the Rhythm Rule are:

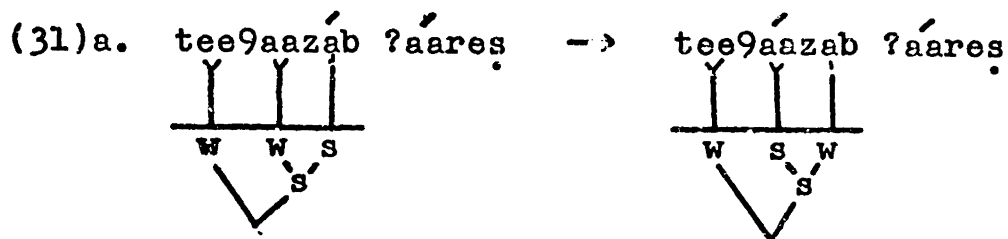

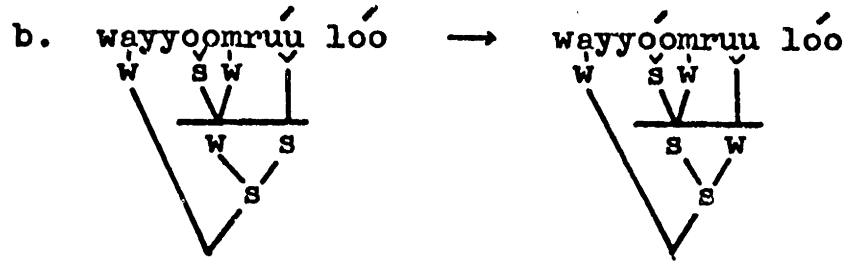

Recall that the Rhythm Rule must never retract stress off of non-final syllables or superheavy final syllables. This follows from the requirement in (30) that the final foot must be non-branching for stress to be retracted off of it. Words like laasuúd, yaaquúmuu accordingly will not undergo the Rhythm Rule.

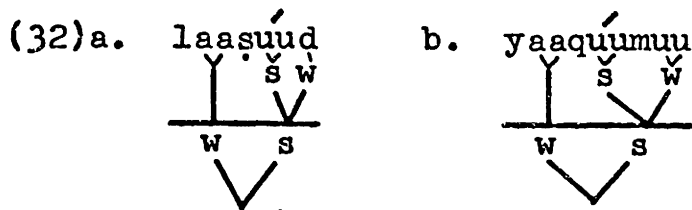

The Rhythm Rule must also be constrained to retract stress only onto long vowels. The formulation of Foot Construction accomplishes this: if a word has no long vowels before the main stress, there won't be any foot to the left of the word final one:

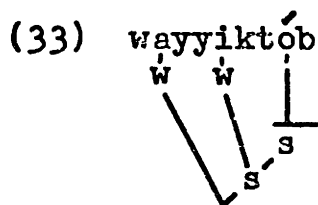

Since the Rhythm Rule can only reverse the labeling of sister feet, it will not apply to words like (33). We will see in the next chapter that this property of the Rhythm

Rule need not be written into the rule, as it follows from a more general principle governing labeling rules.

As we saw before, the only case in which the Rhythm Rule can move stress onto a short vowel is when this vowel heads up a branching structure created by Postguttural Epenthesis, as in na9ǎše. To account for this, we need only assume that the structures Postguttural Epenthesis creates are counted as terminal nodes for the purposes of foot construction. As such, they will escape Deforestation, and will count as terminal branching nodes, so that they can head up feet:

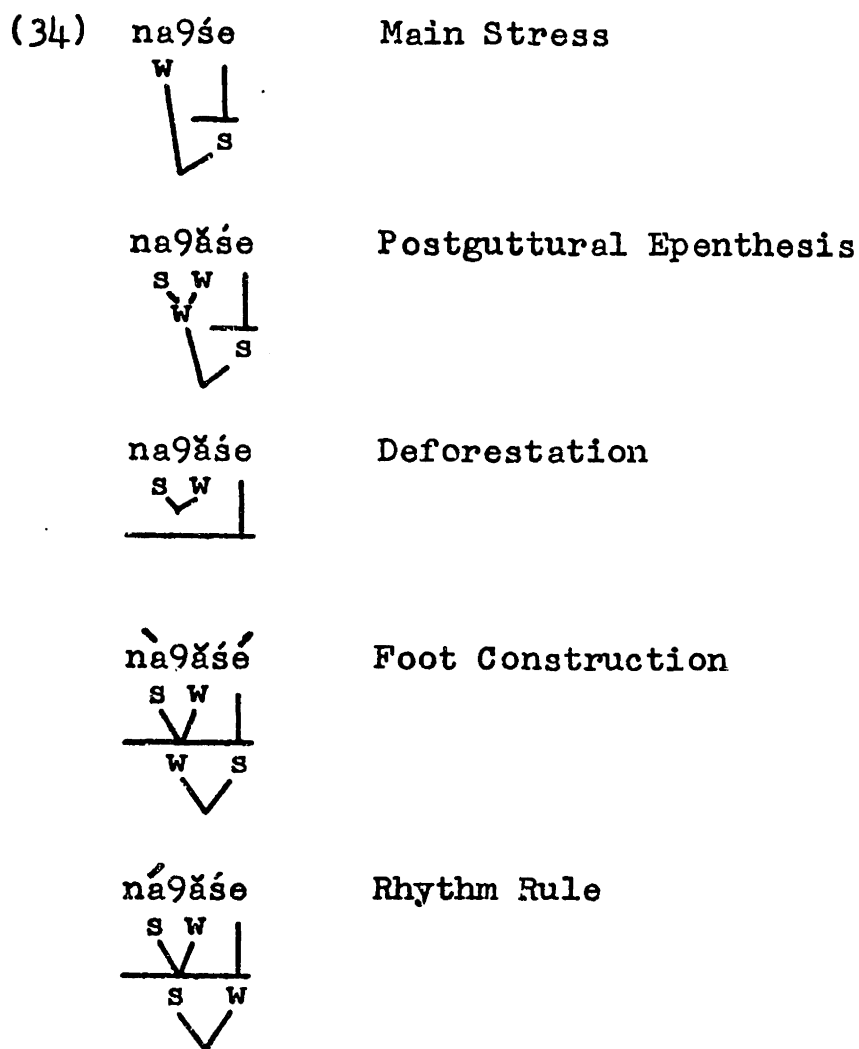

Notice that the ability of the structures created by Postguttural Epenthesis to attract stress by the Rhythm Rule provides a nice argument for the general claim that prominence distinctions based on vowel length are represented as the distinction of branching versus non-branching nodes: it is only under the formal criterion of branching that we can establish the equivalence of long vowels with the more literally branching epenthesis structures for purposes of Hebrew accentuation.

In some words, the tree drawn by the rules established here will determine the secondary stress with no adjustment:

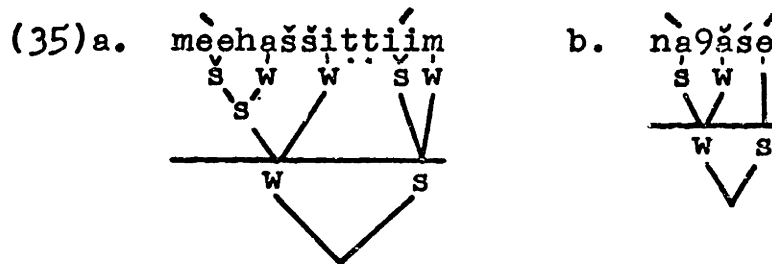

However, the analysis will often produce monosyllabic feet, with erroneous adjacent stresses resulting:

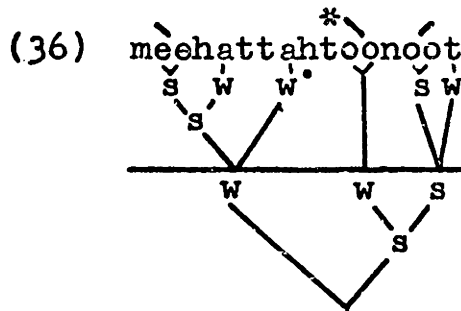

What is needed is a destressing rule, to get rid of the unwanted monosyllabic feet:

(37) Destressing

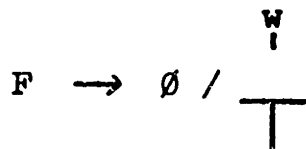

In words, (37) means that non-branching feet are removed in weak position. It applies to meehattahtoonoot as follows:

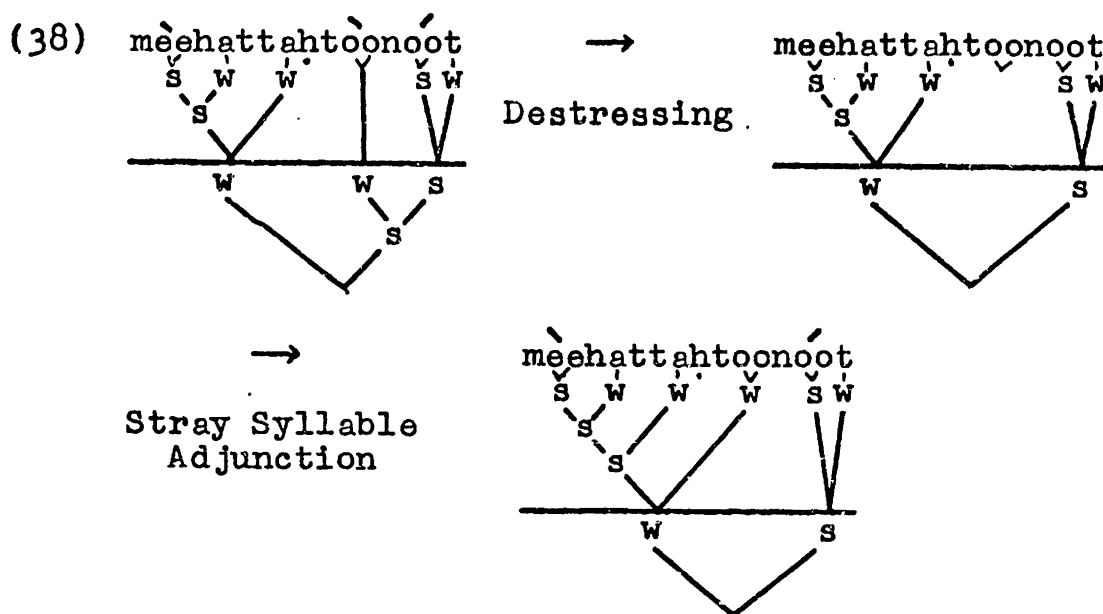

After the foot dominating too is deleted, the resulting stray syllable is adjoined to an adjacent foot by the Stray Syllable Adjunction convention.

A modification of the theory is suggested by words like tèe9aazáb, hàa?ásrii?eelií, and baariíšoonáá. Here we have two or three adjacent monosyllabic feet, so that if Destressing applied to them simultaneously we would get the incorrect *tèe9aazáb, *hàa?ásrii?eelií, and *baariíšoonáá, instead of the observed alternating pattern. A simple way around the problem is to apply Destressing directionally

from right to left. Each time Destressing applies, the resulting stray syllable must be adjoined to the foot on the left, causing that foot to branch if it didn't already. A stressed syllable that precedes the destressed one will thus be rendered immune to destressing, with an alternating stress pattern resulting:

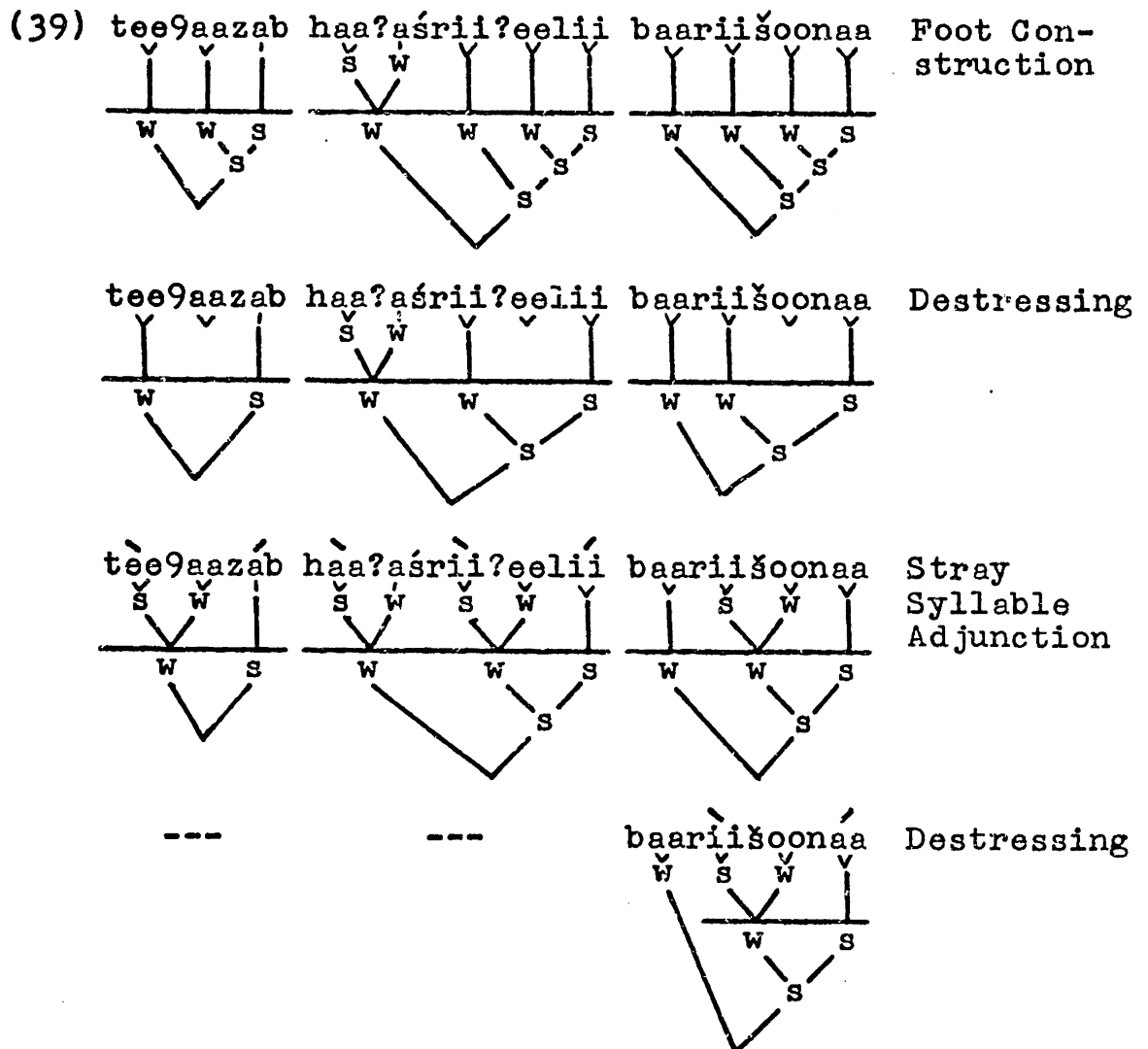

As far as I can tell, this solution will always provide the correct secondary stress pattern for Hebrew words. However, it requires that we sharpen our formulation of Stray Syllable Adjunction. Earlier (p. 120), we claimed that Stray

Syllable Adjunction adjoins a stray syllable to an adjacent foot, without specifying what happens when there are two adjacent feet available for adjoining to. We can see that in Hebrew, Stray Syllable Adjunction must always adjoin to the foot on the left, so that the foot preceding a destressed syllable will be rendered branching and thus no longer destressable. A logical way to guarantee this is to say that Stray Syllable Adjunction is structure preserving, in the sense that it always applies so that structure above the syllable level will be uniformly left or right branching. The following reformulation will accomplish this:

(40) Stray Syllable Adjunction (revised)

Adjoin a stray rime as a recessive node of an adjacent foot.

In other words, adjoin the stray rime as a right branch of a preceding left dominant foot (as in Hebrew, Latin, or Classical Arabic); or as a left branch of a following right dominant foot (as in Winnebago or Aklan). If a syllable cannot be adjoined according to the specification of (40), it is left alone and later incorporated into the word tree. I assume that all syllables adjoined by Stray Syllable Adjunction are labeled as relatively weak by the unmarked labeling convention that marks dominant nodes as strong.

Can this version of Stray Syllable Adjunction be motivated independently? Apparently yes, as is shown in the discussion below of English, and in the following two

observations about Hebrew. Consider the metrical structure which our foot construction rule will assign to a word like yillaahéem: there will be two feet, one constructed over heem by the early Main Stress Rule, and one produced by foot construction over laa:

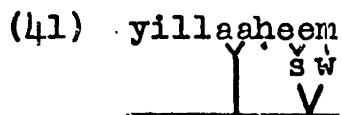

The initial syllable yil doesn't belong to a foot, since it contains no long vowel. It therefore is stray, and according to our old Stray Syllable Adjunction convention, it should be adjoined to the adjacent foot laa:

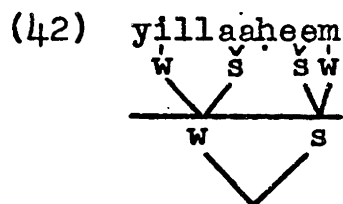

But this would cause the initial foot to branch, protecting it from Destressing and incorrectly predicting secondary stress on laa. The new Stray Syllable Adjunction convention fixes the problem: yil could not join up with laa because, as a left node, it wouldn't be recessive. The foot dominating laa accordingly remains monosyllabic, and destresses as needed:

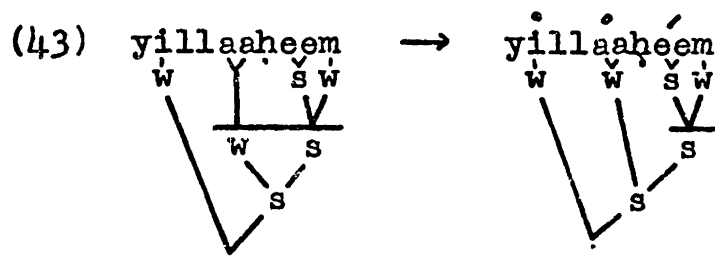

The second place where the new Stray Syllable Adjunction convention comes in handy is in the assignment of secondary stress to superheavy syllables (in practice, to CVVC syllables). These syllables, it will be recalled, differ from CVV syllables in that they may bear secondary stress immediately before another stress, as in (44):

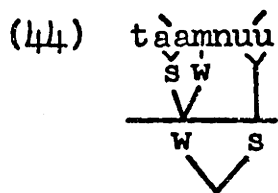

The theory should explain this readily: these syllables don't destress because they contain two rimes and count as branching feet. However, in our framework the feet are assigned on a [+syl] projection, in which the degenerate rime m in (45) is not included:

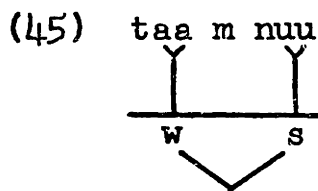

We can make the initial foot of (45) branching by attaching the degenerate rime m to it with Stray Syllable Adjunction. This requires a formulation of Stray Syllable Adjunction that will automatically attach stray rimes in Hebrew to the foot on their left, which (40) does.

We now turn to an argument for why the present analysis should be preferred to McCarthy's. McCarthy notes that in certain cases, the degenerate feet produced under his

analysis must be interpreted as representing secondary stress, as in (46):

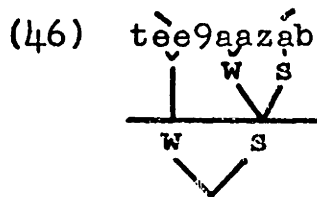

However, when the Rhythm Rule applies to (46), retracting stress to the penult, the secondary stress mysteriously disappears:

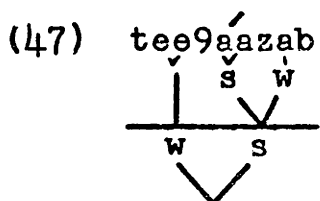

Some further examples show that monosyllabic feet in McCarthy's analysis systematically do not represent a secondary stress just in case the following syllable is stressed:

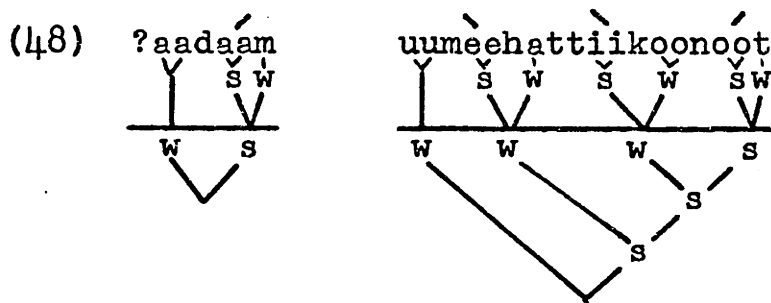

A totally ad hoc principle must therefore be added to McCarthy's system in order to make this interpretation. Under the revised analysis, the absence of secondary stress in the relevant positions is the natural consequence of the Destressing rule. The principle needed to interpret the

metrical structure is the same as it is in all other languages:

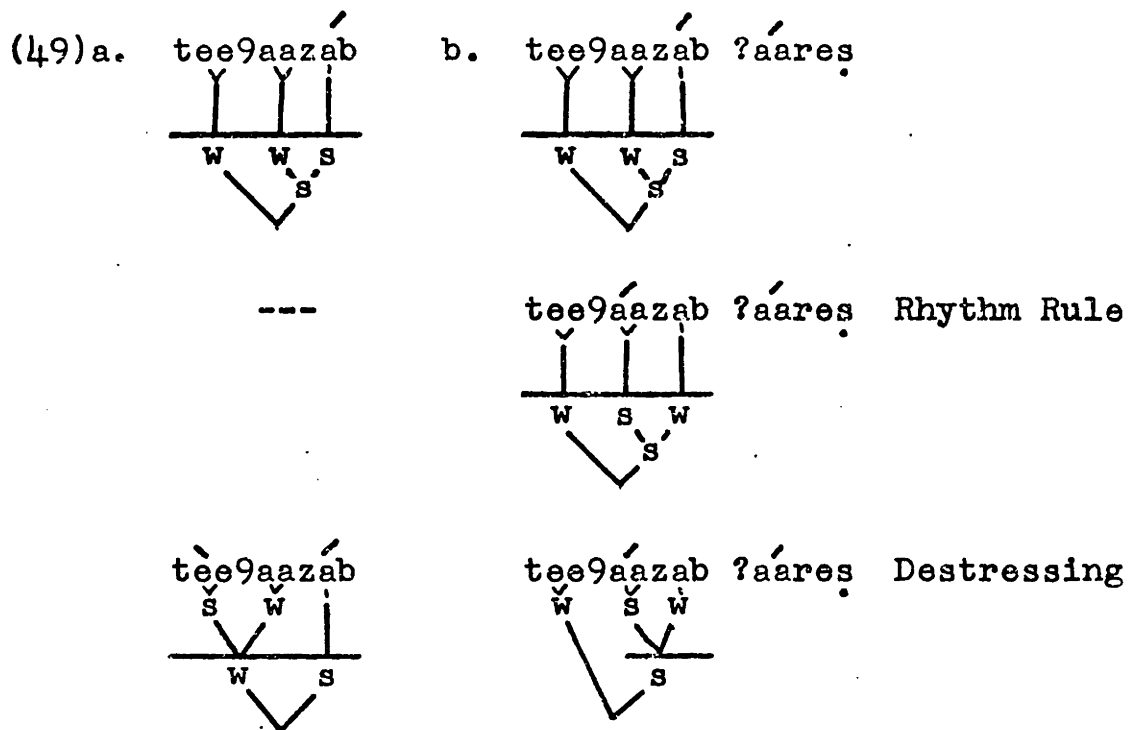

Notice that Destressing also neatly gets rid of the unwanted secondary stress on zab in (49)b.

The new analysis is thus superior to McCarthy's in two ways: it allows the position of the main stress to be carried over from earlier structures in a coherent way, and it needs no ad hoc principle for the interpretation of monosyllabic feet.⁵ To make our claim of having a better analysis stick, however, we must analyze the remaining phenomena in which McCarthy claims feet play a role. The rule of Imperfect Consecutive Stress Retraction is a morphologically governed rule with effects identical to that of the Rhythm Rule. It can be restated in the new framework just

as the Rhythm Rule was, as a rule shifting stress between feet. McCarthy observes that Imperfect Consecutive Stress Retraction and the Rhythm Rule are not ordered adjacently, so that Foot Construction must be regarded not as a rule, but a convention that continually reinterprets the prominence relations of the tree in terms of permissible feet. I will assume an identical procedure here.

The Perfect Consecutive Stress Shift rule changes verbs in the morphological category perfect waw-consecutive from penultimate to final stress, as in wəhádduu → wəhaddúu. The rule is blocked whenever the penultimate vowel is long, as in wəšáábuu, wəhaalaáaktii. McCarthy expresses this distinction by formulating stress shift to apply whenever the last two syllables do not constitute a foot; i.e., as in (50):

$$(50) \quad (s \ w)_\alpha / \text{perfect consecutive, } \alpha \neq \text{foot}$$

↓
w

This is exemplified in (51):

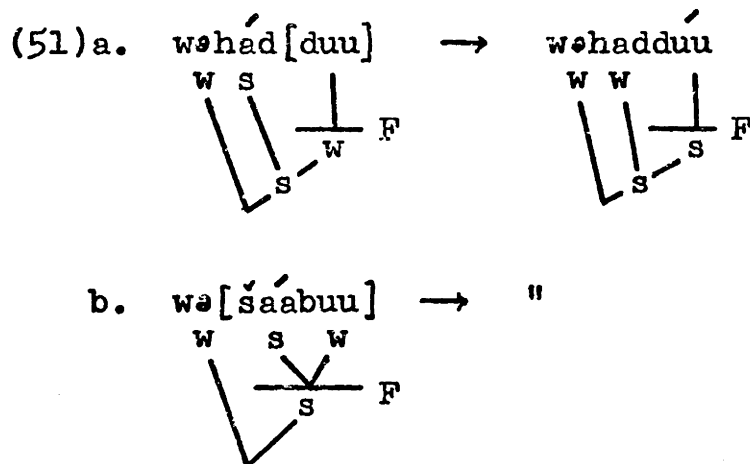

McCarthy claims that his analysis of Perfect Consecutive Stress Shift further supports his theory of Hebrew foot structure, in that it unites the restriction on the Stress Shift rule with the structural requirements found in other Hebrew stress rules. However, it appears that in some cases the analysis simply will not work: consider the derivation of the perfect consecutive form wəhaalaktii from the earlier wəhaaláktii. Under the most obvious interpretation of McCarthy's formalism, the rule will apply correctly only if there is some constituent α , not a foot, which encompasses the last two syllables of the word. If the foot structures of Hebrew are as McCarthy claims, this is not so:

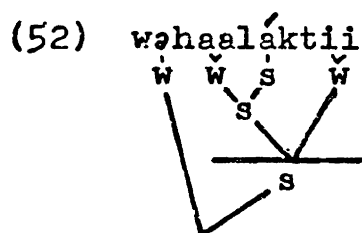

Notice that it would not be possible to correct the problem by allowing the \underline{s} in McCarthy's rule to refer to non-terminal constituents. If we relabeled the subtree dominating haalaktii from $s w$ to $w s$, the stress would indeed shift from lak to tii. But such a relabeling is not allowed, since haalaktii is a foot.

Even if we ignore the problems posed by what () α is supposed to represent, the rule produces the wrong results. Under McCarthy's notation (pp. 158-159), whenever the labeling of a node is changed from w to s , its sister node is

automatically changed from s to w, since metrical labeling is intended as purely relative. In the metrical structure of wəhaalaktii, the sister node of lak is in fact haa, not tii. Thus when lak is relabeled by the rule (50), we would expect stress to shift to the left, not to the right, producing the incorrect result *wəháalaktii. Clearly, some ad hoc modification would be needed to make the rule work properly under McCarthy's theory. Because of these complications, it is hard to see how McCarthy's account of the rule could constitute an argument in favor of his theory of foot structure.

The theory proposed here offers a simpler formulation of the rule: we need only assume that in the relevant morphological categories, the rightmost foot of the word is relabeled so that the dominant node is strong if and only if it branches on the projection [+syll]. This stipulation insures that stress will be shifted to the right only off of syllables containing short vowels, as in (53):

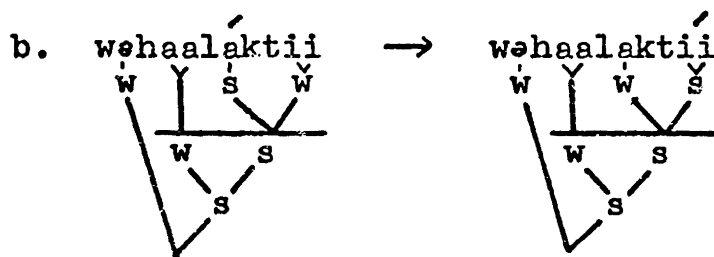
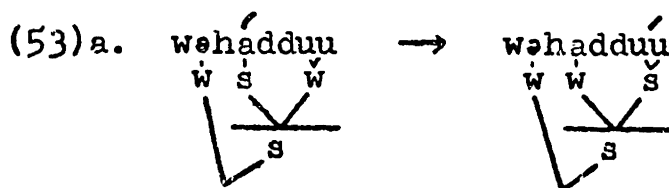

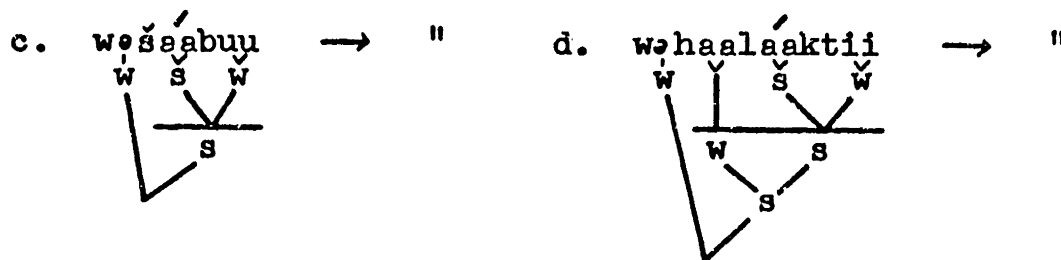

As we will see in the next chapter, labeling rules of this sort are in fact quite common.

We conclude that there are good reasons for preferring the revised analysis over McCarthy's, and as far as we can determine, no cogent reasons for preferring McCarthy's analysis. We have shown, then, that McCarthy's proposal does not constitute a counterexample to the restricted foot inventory presented here. As a postscript, I want to point out that the revised analysis not only doesn't need feet of the type McCarthy proposes, but must also explicitly avoid them. Imagine for the moment a hybrid analysis in which the rightmost foot of the word is constructed by the Deforestation rule of (25), but in which secondary stress is assigned using feet that resemble McCarthy's, except that labeling is always "dominant nodes strong." In words like mehattahtonoot, the new analysis would simplify the derivation, since the alternating secondary stresses could be assigned directly, without the use of Destressing:

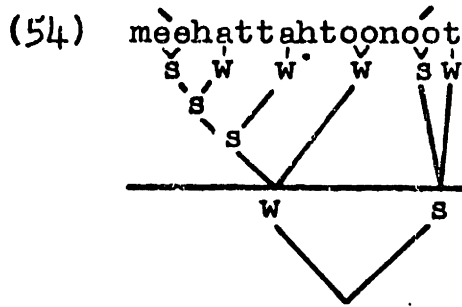

But the destressing rule would be needed anyway to get rid of the unwanted secondary stresses in words like $\text{t\grave{e}e9\acute{a}az\grave{a}b}$ → $\text{tee9\acute{a}azab}$, $\text{?a\grave{a}d\acute{a}am}$ → $\text{?aada\acute{a}m}$, etc. More important, the Rhythm Rule and Imperfect Consecutive Stress Retraction would now produce the wrong results, as in (55):

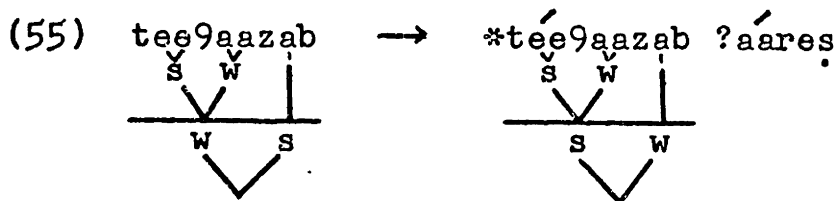

This should be compared with (49)b, in which monosyllabic feet are present earlier in the derivation. The data provided by the stress shift rules show that only the feet of the restricted inventory can account for the facts of Hebrew. The analysis is an example of how restricting the resources of the universal theory can often lead to better analyses of individual languages.

8. Conclusion

In this chapter I have tried to make a case for a rather small universal unmarked inventory of tree geometry. The argument has followed two lines: showing that all the

structures of the inventory are broadly attested, and demonstrating how some of the more obvious counterexamples can be better reanalyzed using other formal devices such as extrametricality or destressing rules. There is a third line of argument which I have been forced to omit, since it involves proving a negative. This is to show that there are no systematic counterexamples to the theory, i.e. tree geometries that are outside the proposed inventory and must be used in the description of many languages. In the absence of thorough analyses of all the stress languages of the world, I can only assert my belief that the claim is true, and invite other researchers to prove me wrong.

Footnotes to Chapter 3

¹For tree sizes and shapes, see Vergnaud and Halle (1978), McCarthy (1979a), Stowell (1979). For theories linking the direction of foot branching with the direction of assignment, see McCarthy (1979a), Pesetsky (1979). Both of the latter theories are counterexemplified by the analysis of Aklan in the previous chapter.

²Malayalam and Banjalong also have secondary stress, which falls on long vowels. This can be derived by constructing an additional layer of metrical structure between the binary feet and the word tree. The trees in this layer would be left dominant and unbounded, constructed on the vowel projection. The word tree would be left dominant (examples from Malayalam):

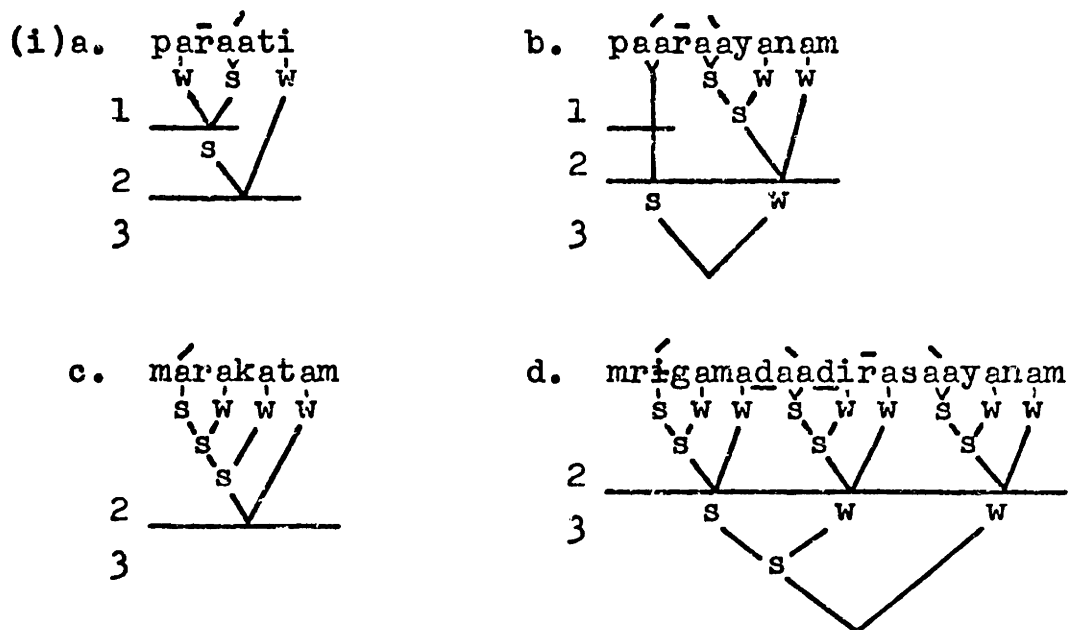

Notice that the level 1 foot forms the dominant terminal node of the level 2 tree structure in (i)a and b. In (i)c and d, neither of the first two syllables has a long vowel, so that only level 2 and 3 trees are formed.

³When foot internal syllables are introduced by Dorsey's Law, any metrical structure that spans them deletes. This phenomenon is apparently not a general one, as contrary cases may be found in Mohawk (Postal 1968) and English (Chapter 5).

⁴I have tried to make the examples of (5) easier to follow by representing the reduced vowels of Meadow Chere-mis all as their optional variant /ə/.

⁵I believe that a clinching argument can be made, but I don't have the relevant examples. Suppose we had a word of the form

(i) $H_a L_0 H_b H_c L_1 \acute{F}$

where H indicates a syllable with a long vowel, L_n a sequence of at least n syllables with short vowels, and \acute{F} is the final, heavy stressed foot of the word. Under McCarthy's theory, such a word would be assigned the structure (ii):

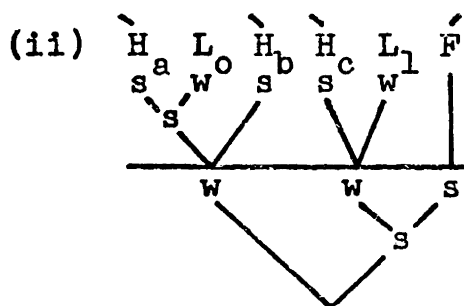

Stress would be assigned to H_b , since the Rhythm Rule may apply only before the main stress of a word. If H_a and H_b are adjacent (i.e. $L_0 = \emptyset$), McCarthy's theory would also predict that H_a would be stressless, since it would no longer be metrically strong within its foot:

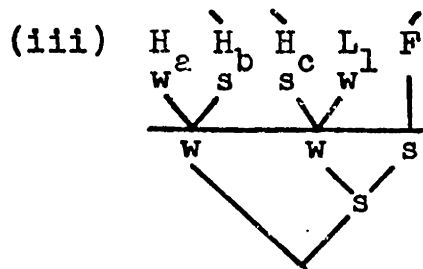

My theory makes a different prediction: since H_b would always be dominated by a non-branching foot, it would be predicted always to destress:

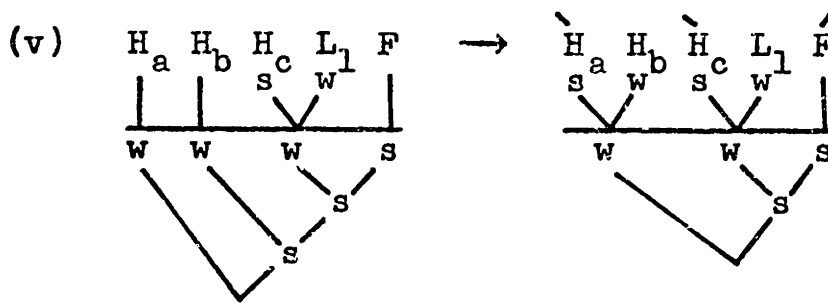
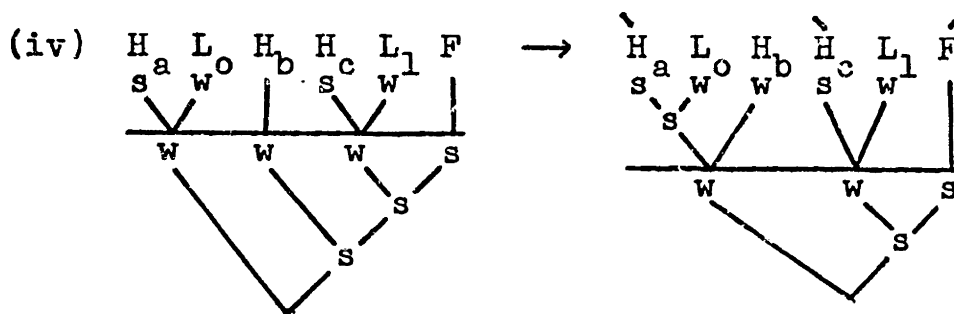

In addition, since H_a never precedes a metrically strong element, it would be predicted always to retain its stress. Certainly the predictions of my theory are much more

plausible, since the alternating pattern of secondary stress is preserved. But in the absence of data, this can't count as an argument.

Chapter 4: Labeling Conventions

1. Common Labeling Conventions

In the last chapter I tried to show that tree geometry constitutes the heart of metrical theory, in that it determines the most interesting constraints on the form of stress rules. In this chapter I will address the subsidiary problem of what constitutes an unmarked tree labeling. It is not hard to find languages in which trees are labeled in ways that are quite unusual, and can't be generalized to other cases. Even so, a healthy majority of cases can be treated in a general theory.

As the reader who has gone through the previous chapter can tell, the maximally unmarked labeling convention is that which makes all dominant nodes strong. No labeling convention to appear in this chapter will have nearly as many illustrative cases, and it would be superfluous to add more here. It is also fairly clear that the convention that wins second place is (1):

- (1) Label dominant nodes as strong if and only if they branch.

This is the normal way of labeling the word tree in English nouns, for example. Since English word trees are right branching, the convention gives the greatest stress to the final foot if it branches, otherwise to the penultimate foot, as in (2):

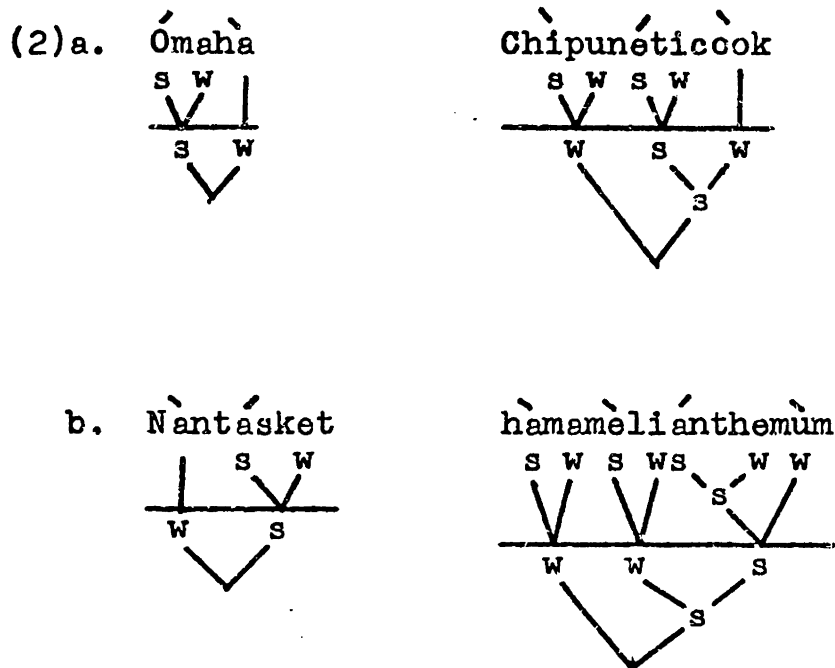

The same labeling convention applies in the word trees of Aklan (Chapter 2), Creek (Chapter 3, p. 102), and Sindhi, discussed in Stowell (1979). Feet may also be labeled in this way. An example is Tahitian, as discussed in Tyron (1976), Vergnaud and Halle (1978). The stress pattern of this language is as follows:

- (3)a. Stress the leftmost long vowel or vowel cluster.
 b. Otherwise stress the penult.

As Tyron states that vowel clusters in Tahitian are tautosyllabic, this stress pattern can be expressed very simply in the following way:

- (4)a. On the [+syll] projection, form a right dominant, unbounded foot, labeling dominant nodes as strong iff they branch.

b. Form a left dominant word tree.

Some examples are:

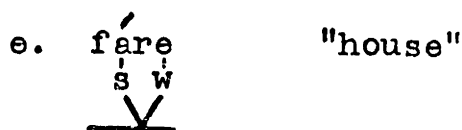
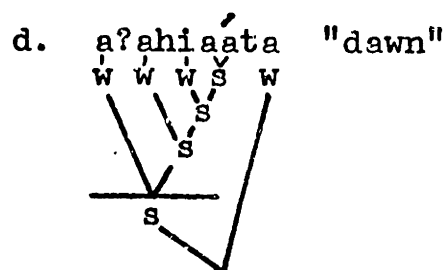
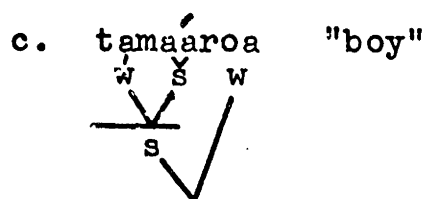
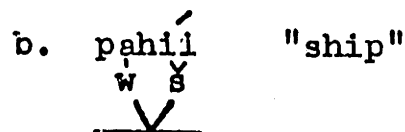
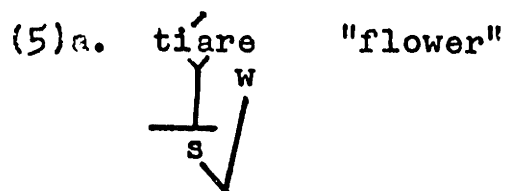

The crucial cases here are (5)e and f. Because these words contain no long vowels, they are encompassed in a single foot; and since the dominant node of this foot doesn't branch, stress falls on the penult.

There are a number of languages in which feet are constructed and labeled essentially in the same way as in Tahitian--see for example Stowell's (1979) analysis of Sindhi and the discussion of Goroa below. In addition, languages with simple penultimate or second stress might be regarded as having unbounded, quantity-insensitive feet labeled so that dominant nodes are strong iff they branch, as we noted in Chapter 3.

As is true elsewhere, it is worth asking whether there are parallel cases among the binary feet; that is, binary feet in which dominant nodes are labeled strong iff they branch. We have already seen one example in the Perfect Consecutive Stress Shift rule of Tiberian Hebrew, which re-labels the binary foot created by the Main Stress^{Rule} using this convention, with the proviso that the rule applies on the [+syl] projection. Another example is the stress pattern of Cairene Arabic, for which I will present an analysis based on the facts presented in McCarthy (1979a,b). McCarthy describes the stress pattern of the Cairene dialect as follows:

- (6)a. Stress a superheavy ultima.
- b. Otherwise stress a heavy penult.
- c. Otherwise stress the penult or antepenult, whichever is separated by an even number of syllables from the rightmost nonfinal heavy syllable or, if there is no nonfinal heavy syllable, from the left boundary of the word.

The portion of the pattern under a is handled in the same way as it is in Classical Arabic, in which final superheavy syllables also receive stress: the superheavy syllables are analyzed as having two rimes ($VCC = VC + C$, $VVC = VV + C$), so that on the rime projection a final superheavy syllable receives stress just as a penultimate heavy syllable would. The remainder of the pattern is

where the greater interest lies: the metrical structure must somehow provide for an odd-even count of light syllables from left to right. McCarthy's way of doing this is as follows:

- (7)a. From left to right, construct binary feet in which neither node may branch.
- b. Gather all feet and stray syllables in the word into a right branching word tree.
- c. Label all structure so that right nodes are strong iff they branch.

This stresses the words of (8) correctly as follows:

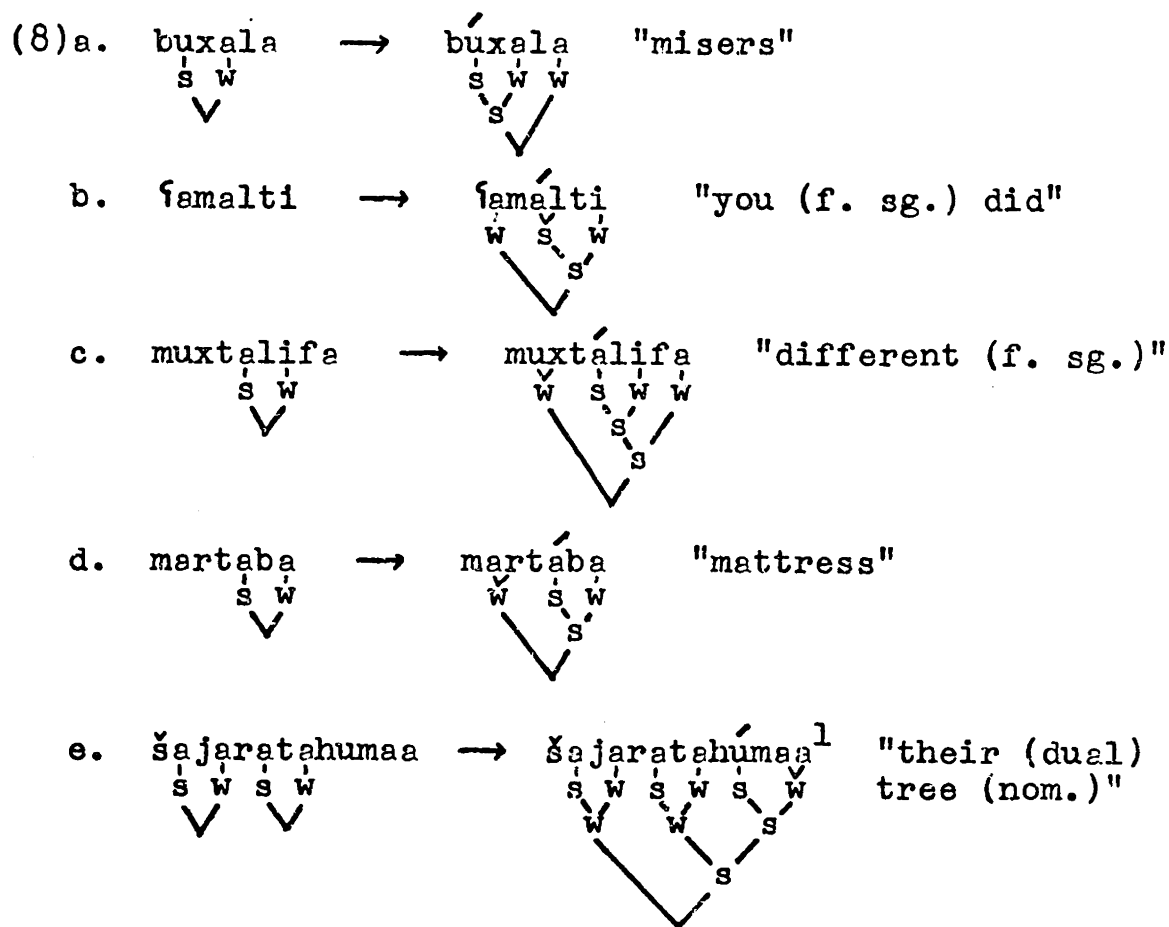

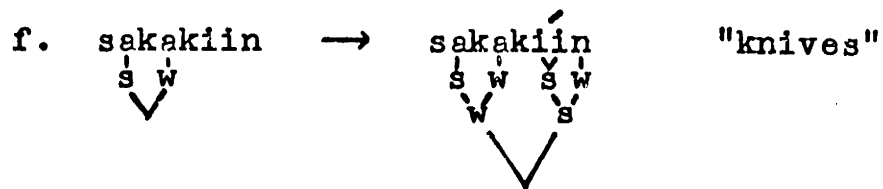

However, this rule would be highly marked under our system: we haven't allowed for any feet of the form $\begin{array}{c} \wedge \\ | \quad | \end{array}$, i.e. binary in which neither node may branch. I am not aware of any other languages in which this sort of foot must be assigned.

Another solution is possible which stays within the bounds of the present theory:

- (9)a. Mark word final rimes as extrametrical.
- b. From left to right, assign binary, right dominant feet on the rime projection. Construct a right dominant word tree.
- c. Label all metrical structure so that dominant nodes are strong iff they branch.

This will stress the words of (8) in the following way:

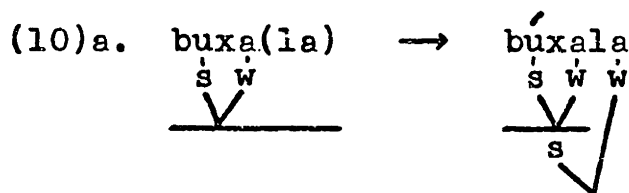

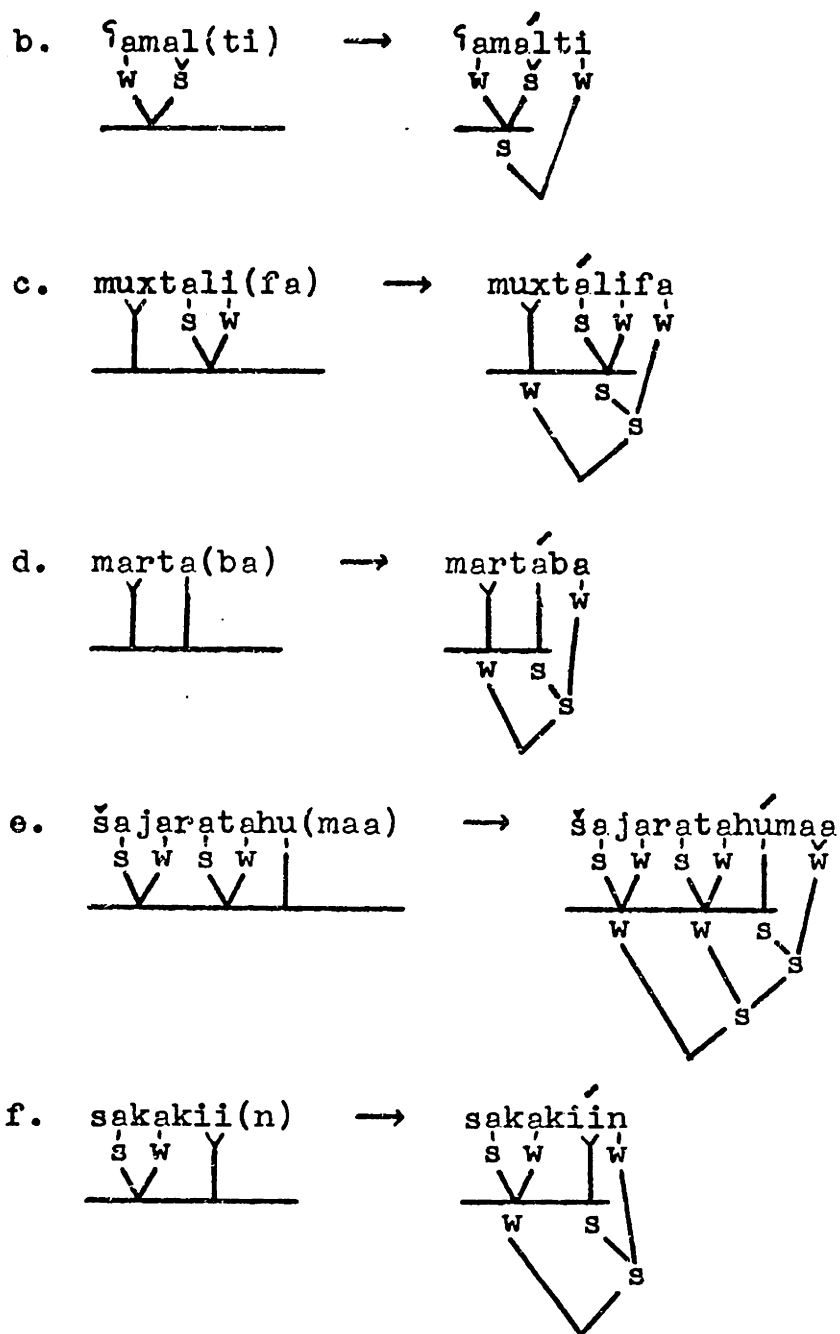

The analysis has the advantage of being precedented, as both the tree shapes and the labeling are attested elsewhere. Notice that the extrametrical syllables in (10) are adjoined to the word tree, not the adjacent foot, since the feet are right dominant.

Prince (1980) has suggested a constraint that would simplify the above analysis somewhat. The constraint is

based on the observation that the Rhythm Rule in English may not retract stress onto a stressless syllable; cf. Christine, Christine Smith vs. Coreén, *Coreen Jónes. This would follow from a constraint of the form (11):

- (11) Feet are always strong with respect to syllables, regardless of the specification of any labeling rule.

By adopting this constraint, Prince notes, we can simplify the statement of the English Rhythm Rule, eliminating any specification that the constituent being relabeled as strong must be a foot. The constraint will prevent the simplified rule from generating any ill-formed labelings such as (12):

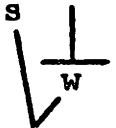
- (12) *Coreen Jónes

In this thesis there are two examples that support Prince's claim. The first is our formulation of the Hebrew Rhythm Rule, repeated as (13):

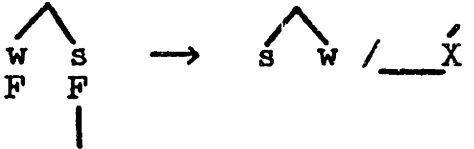
- (13)  in the appropriate syntactic context

The rule stipulates that the constituent which is relabeled as strong must be a foot, in order to account for the contrast between examples like (14)a and b:

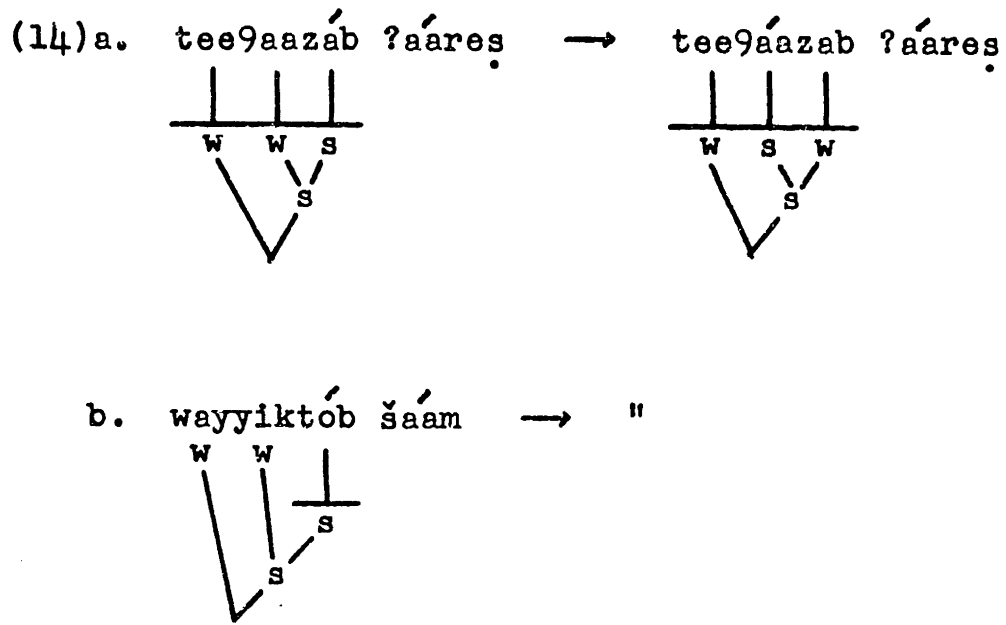

It turns out, however, that this stipulation was unnecessary, as it follows from the principle of universal grammar embodied in (11). Prince's idea thus would allow us to simplify the Hebrew Rhythm Rule, eliminating the leftmost F from its structural description, while at the same time increasing its explanatory value.

The second example that supports Prince's idea lies in the analysis of Cairene Arabic just proposed. If we adopt the constraint, then we needn't specify a labeling rule for the Cairene Arabic word tree. Instead, we allow the unmarked labeling convention "dominant nodes strong" to apply. The principle (11) will then override the normal labeling and make the word final stray syllable weak, since its sister node is a foot:

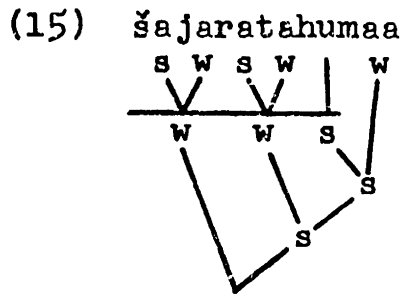

In certain stress rules, it appears that the labeling of the tree must employ a different criterion of syllable prominence than tree construction. Consider, for example, the stress system of Capanahua, as analysed in Loos (1969) and Safir (1979). In this language, stress falls on the second syllable if it has a branching rime, and otherwise on the first syllable:

- | | | |
|--------|---------|--------------|
| (16)a. | karičwi | "go soon" |
| | piškáp | "small" |
| b. | čičika | "knife" |
| | sóntako | "young girl" |

(A slight complication is involved in that branching within the syllable nucleus must be ignored; see Chapter 3, p. 75.) Notice that this stress pattern is reminiscent of the Aklan system, in which stress always falls on the penultimate syllable if it is heavy. However, there is additional evidence that an analysis paralleling that of Aklan would not be correct for Capanahua. Safir discusses a rule of Glottal Deletion, which deletes /ʔ/ syllable finally when it occurs in an even numbered syllable, followed by a consonant. Such

a rule rather strongly suggests the construction of binary, quantity insensitive feet from left to right across the word, in order to establish the odd-even syllable count. As Safir points out, the glottal deletion rule can then be stated as dropping glottal stops in foot final position, as in (17):

$$(17) \quad ? \rightarrow \emptyset / \text{---}]_{\text{Foot}} \text{ }^{\text{C}}$$

Some examples are as follows:

$$(18) \text{ a. } [pi\check{c}a?]_{\text{F}} [čikin]_{\text{F}} \rightarrow pi\check{c}a\check{c}ikin \quad \begin{array}{l} \text{"poked him in} \\ \text{the ribs"} \end{array}$$

$$\text{ b. } [?o\check{c}i]_{\text{F}} [tira?]_{\text{F}} [ta?ki]_{\text{F}} \rightarrow ?o\check{c}itirata?ki$$

"it is probably a dog"

Given the independent need for a binary foot dominating the first two syllables of the word, the most plausible account of stress would be to say that it is derived by labeling this foot in the appropriate way, especially since the labeling rule needed is a natural one. Specifically, we could specify that (a) The feet are right dominant; (b) Although the feet are constructed without regard to quantity, they are labeled so that dominant nodes are strong iff they branch on the rime projection; (c) The word tree is left dominant. Some examples are as follows:

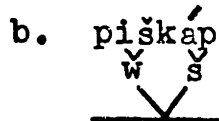
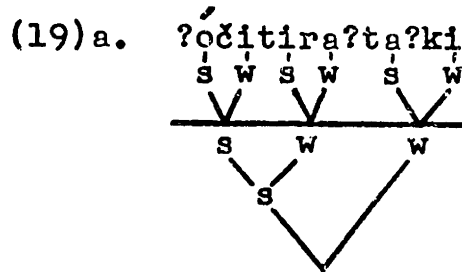

This is essentially the analysis advocated by Safir.

A more intricate example of a case in which the prominence criteria for foot construction and labeling differ is found in Goroa (Seidel 1900). From Seidel's transcriptions we can infer that normal stress placement is as follows:

- (20) a. Stress the leftmost long vowel or diphthong.
 b. Otherwise stress a final closed syllable.
 c. Otherwise stress the penult.

Some examples are

- (21) a. $\overset{\cdot}{d}u\overset{\cdot}{u}g\overset{\cdot}{u}n\overset{\cdot}{o}o$ "thumb"
 $\overset{\cdot}{g}o\overset{\cdot}{g}o\overset{\cdot}{m}\overset{\cdot}{a}\overset{\cdot}{a}r\overset{\cdot}{i}$ "short"
 $\overset{\cdot}{g}i\overset{\cdot}{r}\overset{\cdot}{a}m\overset{\cdot}{b}\overset{\cdot}{o}\overset{\cdot}{o}d\overset{\cdot}{a}$ "snuff"
 $\overset{\cdot}{w}\overset{\cdot}{a}\overset{\cdot}{u}\overset{\cdot}{t}i\overset{\cdot}{m}\overset{\cdot}{o}o$ "prince"
 $\overset{\cdot}{h}e\overset{\cdot}{n}i\overset{\cdot}{n}\overset{\cdot}{a}\overset{\cdot}{u}$ "young"
- b. $\overset{\cdot}{a}d\overset{\cdot}{u}\overset{\cdot}{x}$ "heavy"
 $\overset{\cdot}{a}x\overset{\cdot}{e}m\overset{\cdot}{i}\overset{\cdot}{s}$ "hear"

c.	oromíla	"because"
	amrámi	"ivory arm ring"
	ifirdána	"sweet"

This stress pattern can be derived very simply, provided that we allow tree construction and labeling to apply on different projections:

- (22)a. On the [+syl] projection, form an unbounded right dominant foot at the left edge of a word. Label dominant nodes as strong iff they branch on the rime projection.
- b. From a left dominant word tree.

Some sample derivations are as follows:

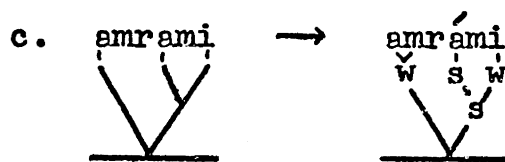
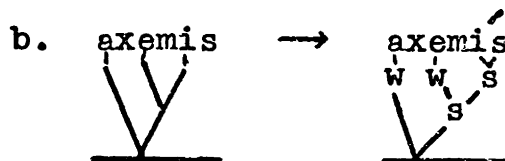
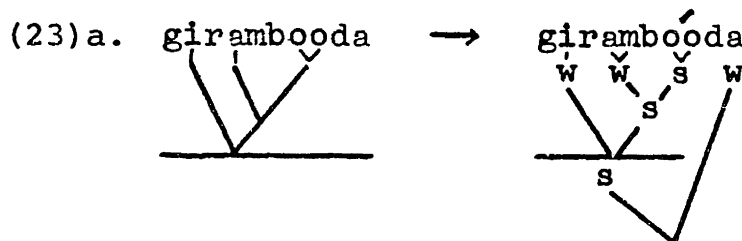

Other cases can be found in which tree construction and labeling respect different criteria of prominence. For

example, the word trees of Aklan and English clearly have this property: the rules that construct them must be insensitive to branchings within the foot, since they would otherwise not be able to encompass the entire word. But as we have seen, the labeling of the word trees is sensitive to the branching of the dominant terminal node. In addition, languages like Ossetic and Rotuman, described in Chapter Three, might be analyzed as having a single, unbounded, quantity insensitive foot per word; with dominant nodes labeled strong if they branch on the [+syll] projection. However, the analyses of Chapter 3, using foot geometry, seem equally plausible.

2. Rarer Labeling Rules

The two labeling conventions presented so far--dominant nodes strong, and dominant nodes strong iff they branch--are the most common cases. In this section I will present some of the more unusual labeling rules that appear to be necessary. The list is by no means complete, as I intend only to give some notion of the variety that is found.

The Rhythm Rule of English is a good example of a labeling rule that is sensitive to the branching of both dominant and recessive nodes. We will ignore here the external context for the rule, which is discussed in Chapter 3, p.152, and concentrate on how the branching of the feet affected determines whether the rule is applicable. Of the four logical possibilities:

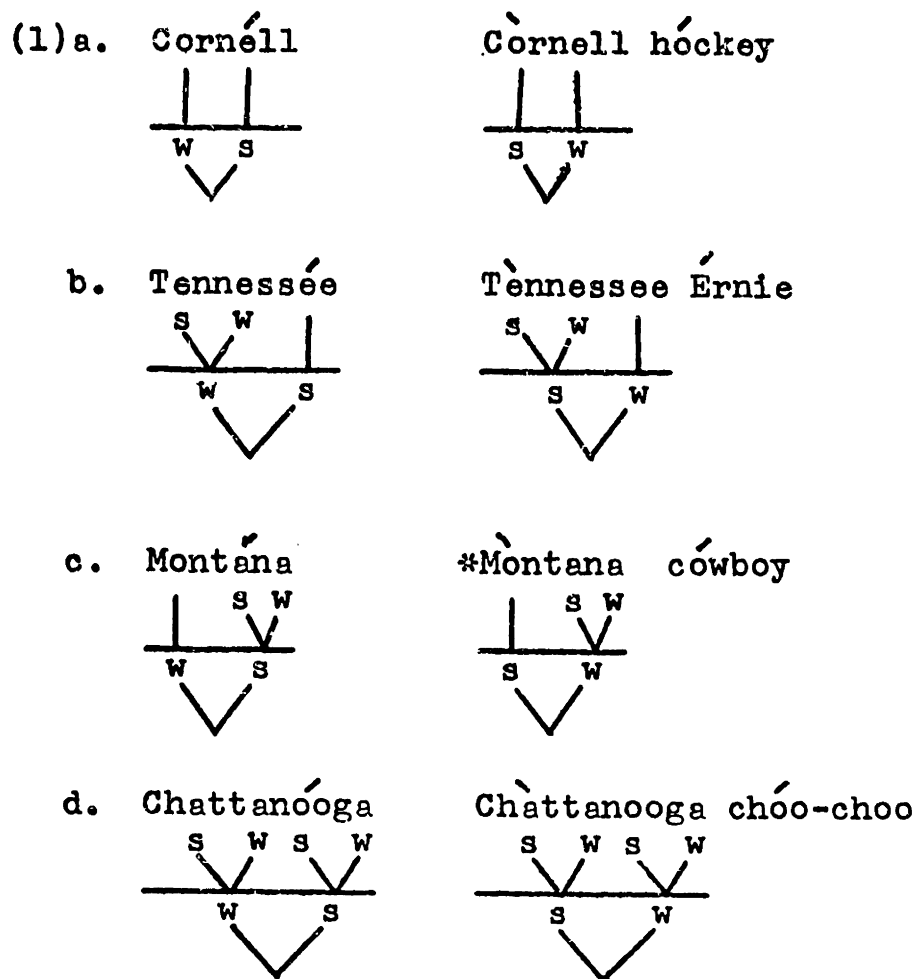

we find that only one configuration blocks the rule: the case in which the foot on the right branches and the foot on the left doesn't. We will see later that word trees in English are right dominant, so that the Rhythm Rule can be stated as follows:

- (2) In the appropriate context, relabel w s as s w if either the recessive node branches, or the dominant node does not.

The input to the rule must be specified as w s in order to prevent words with the stress pattern $\overset{\cdot}{x} \overset{\cdot}{x} x$ from being

re-labeled, as in cùcumber blúes, Ròchester Réd Wings (*cucùmber blúes, *Rochèster. Réd Wings).

A counterpart to the labeling of the Rhythm Rule is found in the labeling of monomorphemic English verbs, discussed in Liberman and Prince (1977). Here we find that the dominant node is labeled weak only if it does not branch and its sister node does:

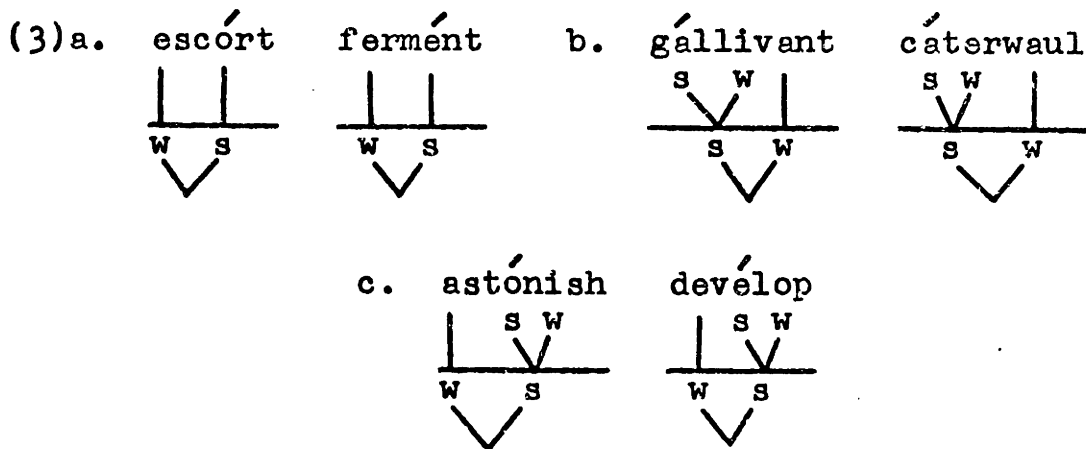

English appears to lack verbs with four syllables and penultimate stress (gerrymander is underlyingly trisyllabic; see Chapter 5). But there seems to be little doubt that such verbs would have penultimate main stress, as the reader can determine by mentally stressing imaginary verbs such as gerrimandish, ferrelango. The situation is further complicated by the fact that monosyllabic feet in dominant position are labeled strong even if the corresponding recessive node branches, provided that they dominate a stem: interséct, comprehénd.

A foot labeling rule that resembles the last two examples can be found in Somali (Reinisch 1903). Here stress is

penultimate in all cases except when the penultimate vowel is short and the final vowel is long, in which case stress is final. This suggests two possible analyses, both of which require a labeling rule that refers to both dominant and recessive nodes. In either case, we would form a binary, quantity insensitive foot at the right edge of a word. If the right node is specified as dominant, we would label the foot using the same procedure as the English Rhythm Rule, i.e. dominant nodes strong if they branch and their sister node doesn't. Similarly, if the left node is specified as dominant, we would use the labeling rule for English verbs; i.e. dominant nodes strong iff they branch or their sister doesn't. In either case, the word tree will be right dominant. Some examples are as follows:

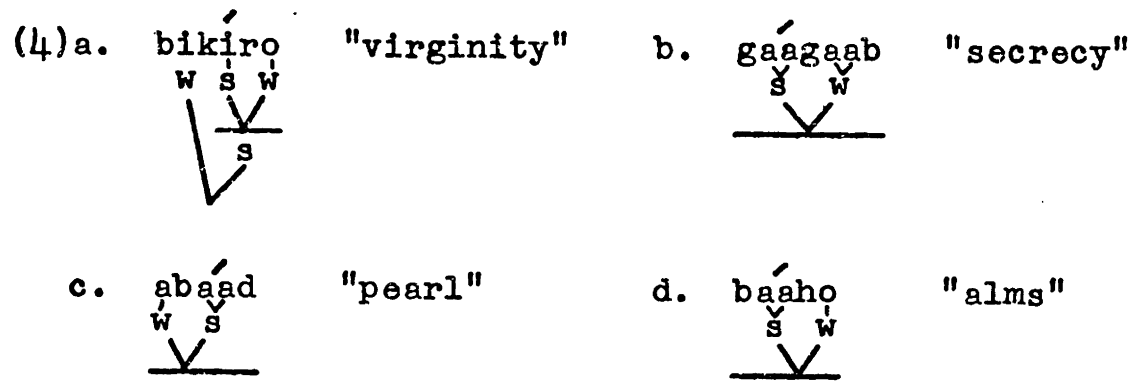

Another exceptional labeling rule found in English characterizes a pattern first discovered by Oehrle (1971): generally a word final foot will be labeled strong even if it is monosyllabic, provided that its sister foot dominates a single non-branching rime. The weak sister foot usually is later removed by a Destressing rule to be described in

Chapter 5:

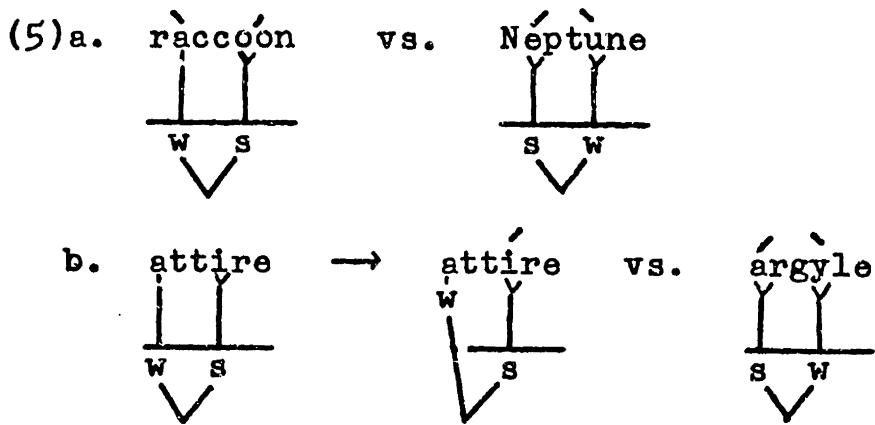

This rule raises the question of just when a foot may be said to branch: is it when it dominates at least two segments on the appropriate projection or is it when it dominates at least two rimes? The latter criterion is supported by the word tree labeling rules of Aklán and English, as the trees of (6) suggest:

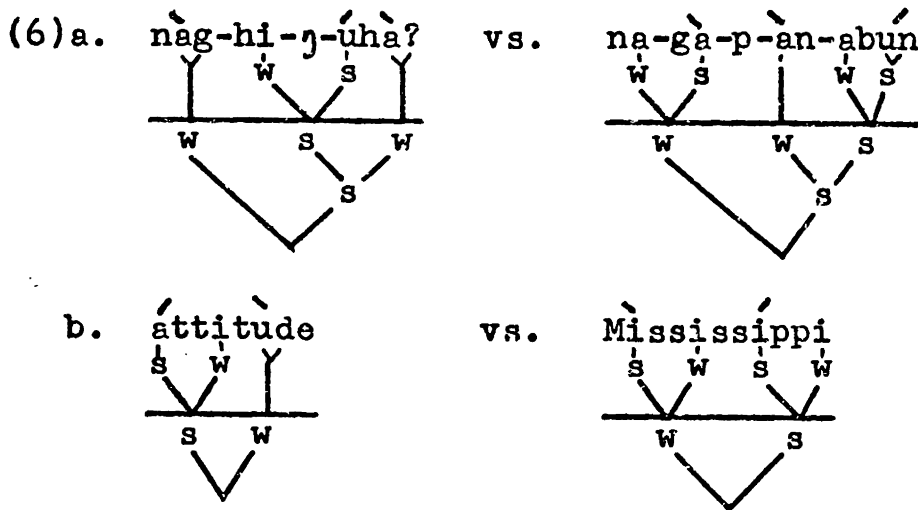

It is also the right criterion for Tiberian Hebrew. As we have seen, the Hebrew Rhythm Rule may not retract stress off of a foot that branches into two rimes, although it can retract stress off of a foot that dominates a single branching

rime:

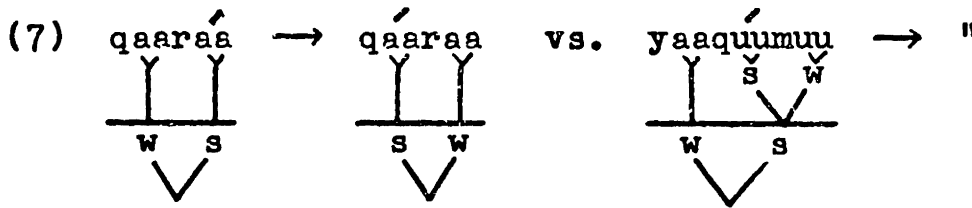

There are too few examples available to decide which criterion, if either, is the unmarked one.

The last unusual labeling convention I will discuss here has been suggested by Stowell (1979) and Safir (1979) for the word trees of languages like Finnish (Carlson 1978), Livonian (Sjögren 1861), Winnebago (Hale and White Eagle 1979), Passamaquoddy and Seneca (Stowell 1979). In the first three of these languages, the leftmost foot receives the greatest prominence, with each successive foot going from left to right receiving less prominence than its predecessor. The remaining two have the mirror image, with a gradual crescendo of stresses up to the final one. This can be expressed in metrical notation using trees in which all recessive nodes are strong:

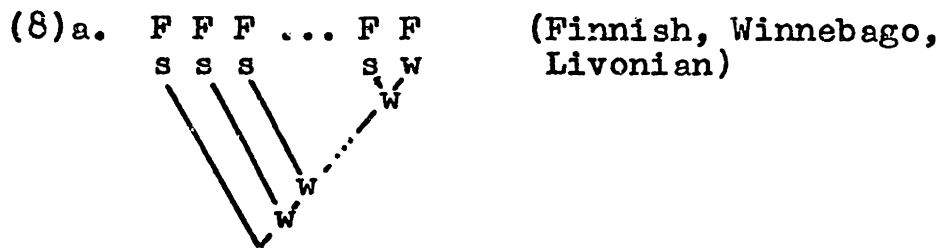

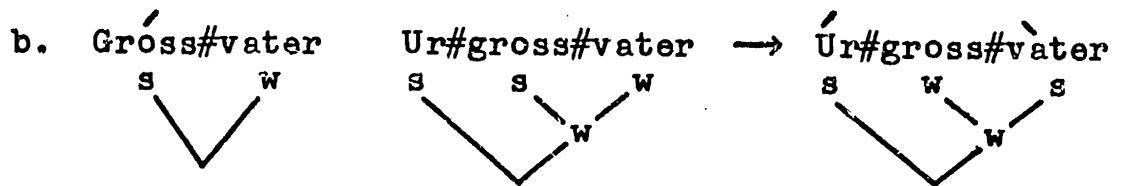

The fact that such adjustments do not occur in Finnish et. al again suggests that the structures of (8) are not the correct word trees for these languages.² A very interesting example along these lines can be found in Finnish. It can be argued that Finnish has a rhythm rule of the form (10):

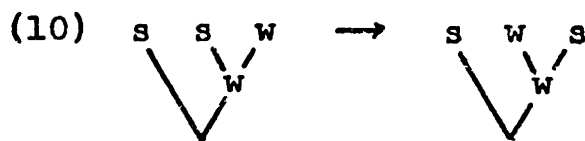

As evidence for this, observe that the compound noun sästö#pankki "savings bank" reverses its stress contour when a stronger stressed word immediately precedes it in a phrase:

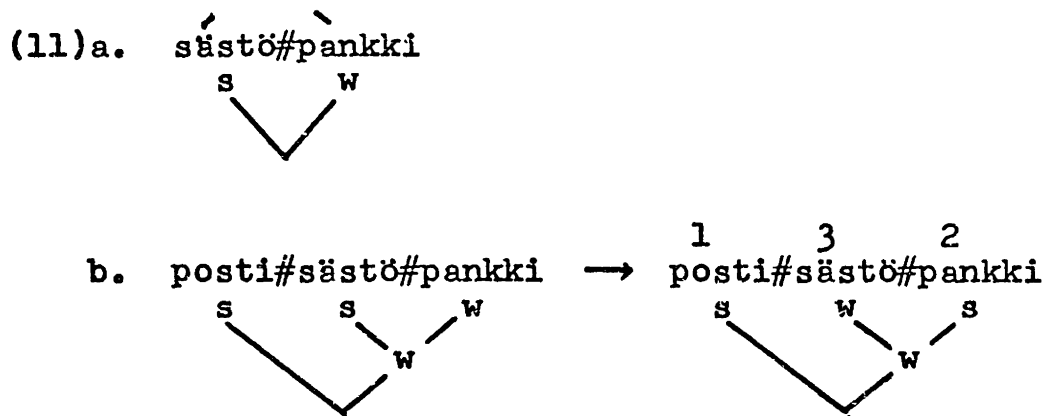

"postal savings bank"

Let us now compare (11)b with a single word having three feet. If kálastamattomána "not having been fished" has the right branching structure^{proposed} for it by Stowell and Safir, we would expect it to undergo the same relabeling as that found in postisästöpánkki, as in (12):

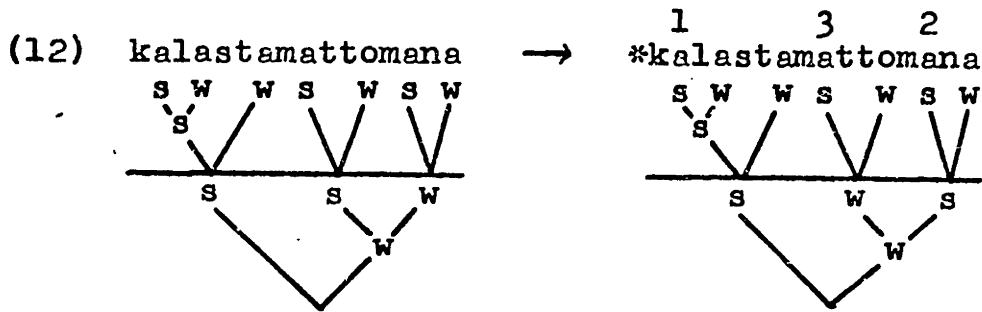

But it does not: the first secondary stress is generally perceived to be stronger than the second (or equal to it, for some speakers). Thus the word tree of (12) seems inadequate as a way of accounting for this stress pattern.

I am not sure what is the correct way to resolve the problem posed by stress systems of the Finnish type, and will only make a suggestion here. I suspect that what is wrong with the theory is the assumption that secondary stresses always receive prominence in inverse proportion to their degree of embedding. A priori, nothing dictates that this must be true; and in fact there are many languages in which there is no evidence for any distinctions at all among the secondary stresses. Suppose, then, that the interpretation of weak nodes is a language-specific matter: the weak nodes of a tree can be interpreted as prominent in either inverse or direct proportion to their degree of embedding, or they

may be interpreted as equal. If this is so, we may replace the trees of (8)a and b with ordinary left and right branching trees respectively, labeled so that dominant nodes are strong, with the weak nodes prominent in direct proportion to their degree of embedding. We can then explain why the stress clashes of these languages do not result in relabeling, since structures of the form $s \ s \ w$ or $w \ s \ s$ are not found.



3. Stress in Yidin^Y

Yidin^Y is an Australian language described in a remarkably detailed and insightful grammar by R. M. W. Dixon (1977b, henceforth GY). A useful, briefer account of most of the facts to be dealt with here is found in Dixon (1977a). I will discuss the phonology of Yidin^Y at some length, partly to present its rather unusual foot labeling rule, and partly to show the utility of metrical theory in describing the facts of Yidin^Y. The analysis to be presented is in most respects Dixon's; my purposes are mainly limited to showing how metrical notation expresses the patterns Dixon has discovered in a simple and natural way, and how it removes those aspects of Dixon's analysis which many phonologists would find objectionable.

According to Dixon, stress in Yidin^Y is assigned by the following rule:

- (1) Stress is assigned to the first syllable involving a long vowel. If there is no long vowel, it is assigned to the first syllable of the word.

Further stresses are then assigned (recursively) to the syllable next but one before, and the next but one after, a stressed syllable.

The rule looks complicated, as it involves a left to right scan to find the first long vowel, plus recursive assignment of alternating stresses in both directions. To understand the rule better, we must examine the patterning of long vowels in Yidin^y. These derive from four different sources: a rule of Penultimate Lengthening, some length inducing suffixes, a glide vocalization rule, and (rarely) underlying representation.

Penultimate Lengthening lengthens the penultimate vowel of a word with an odd number of syllables. Dixon doesn't state the rule formally, but a fair representation of his intent in standard notation would be (2):

(2) Penultimate Lengthening

$$V \rightarrow [+long] / \#C_0V(C_0VC_0V)_0C_0\text{---}C_0VC_0\#$$

The effects of the rule are illustrated in the following examples, with the derivations of gáli-ŋ "go-present" gudá:ga "dog-absolutive", gúdagá-gu "dog-purposive", and gudágudá:ga "dog-reduplicated-abs.":

(3)a. Even-Syllabled Words

galiŋ gudagagu

Penultimate Lengthening

gálin	gúdagágu	Stress
-------	----------	--------

b. Odd-Syllabled Words

gudaga	gudagudaga	
guda:ga	gudaguda:ga	Penultimate Lengthening
gudá:ga	gudágudá:ga	Stress

There are three verbal suffixes in Yidin^Y that induce length on the preceding vowel: the antipassive -:d^Yi/-:rd^Yi, the "going" aspect -:li/-:ri/-:ri, and the "coming" aspect -:ldan/-:dan. I will indicate these suffixes in transcription by underlining them. Vowels that receive this morphologically governed length are stressed in the usual way, as in /wawa/ → wawá:-d^Yi-ŋ "see-antipassive-pres.," /wujaba/ → wúgabá:-d^Yi-ŋ "hunt-antipassive-pres." Notice that unlike Penultimate Lengthening, the morphological lengthening rule may place stress on odd-numbered syllables, as the latter example shows.

The third source of long vowels is a rule Dixon calls Yotic Deletion. Yidin^Y has a constraint to the effect that no syllable may end in /i(:)y/ on the surface. However, Dixon presents ample evidence that such sequences may occur underlyingly. Underlying /iy/ is realized as /i/ before a consonant and /i:/ word finally; while /i:y/ always surfaces as /i:/. We can formulate the rule segmentally as in (4):

(4) Yotic Deletion

$$iy \rightarrow \left[\begin{array}{c} i \\ \langle +\text{long} \rangle \end{array} \right] / ______]_{\$} \langle \# \rangle$$

where]_{\$} indicates the right edge of a syllable. Some examples are

- (5)a. galbiy "catfish-abs."
galbí: Yotic Deletion
- b. galbiy-gu "catfish-purposive"
galbi:y-gu Penultimate Lengthening
galbí:-gu Yotic Deletion
- c. gadigadiy-ni-ŋgu "very small children-genitive-ergative"
gádígádi-ní-ŋgu Yotic Deletion

Notice that in (5)a the long vowel derived from /iy/ attracts stress by the regular rule.

The remaining source of long vowels is lexical representation, as in durgú: "mopoke owl-abs.," galámbará: "march fly-abs.," wará:bugá "white apple tree-abs." Remarkably, these long vowels occur in only 17 morphemes, and always fall in even numbered syllables. As the examples show, underlying long vowels attract stress in the ordinary way.

There is one more rule that mediates between the vowel

length as it is determined above and the stress rule.

Dixon describes it as follows:

(6) Illicit Length Elimination

Shorten vowels occurring in the even syllables of a word having an odd number of syllables.

It applies in derivations like (7):

- (7) barganda-d^yi-n^yu "pass by-antipassive-past"
 barganda:-d^yi-n^yu Lengthening before -d^yi
 barganda:-d^yi:-n^yu Penultimate Lengthening
 barganda-d^yi:-n^yu Illicit Length Elimination
 bargánda-d^yi':-n^yu³ Stress

We can now begin to dissect Dixon's formulation of the stress rule, as it is listed under (1). First, we can ask if the provision requiring that the first long vowel be located is necessary. In words having an odd number of syllables, it will not: all long vowels must occur in even numbered syllables by virtue of Illicit Length Elimination, so that any long vowel can be taken as the starting point for the alternating pattern. The only possible case in which finding the leftmost long vowel would be crucial would be in an even-syllabled word having long vowels in both odd and even syllables. Interestingly, there are no such words: they could not arise through the interaction of Penultimate Lengthening and some other source, since this rule only applies in odd-syllabled words. Furthermore, a grand

conspiracy in the Yidin^y morphology prevents a conflicting length pattern from arising through any of the other sources of vowel length. There is thus no need to specify that the stress rule locates the first long vowel--all that is needed is (8):

(8) Stress Rule (II)

Stress long vowels, or the initial syllable in words having no long vowels. Stress alternating syllables before and after another stress.

There is another, equivalent way of stating (8): suppose we rephrase the rule as (9):

(9) Stress Rule (III)

Stress even numbered syllables if there is an even numbered syllable with a long vowel. Otherwise stress odd numbered syllables.

Under this formulation, there is no need to clean up any vowel length clashes before the rule applies. The only clashes that occur are found in odd-syllabled words, which always receive stress on even syllables, as (9) predicts. Suppose, then, that length clashes are resolved after the stress rule applies. If this is so, we can radically simplify the shortening rule, expressing it in a phonetically natural way as well:

- (13)a. gali-n^Yu "go-past"
 gali:-n^Yu Penultimate Lengthening
 gali:-n^Y Final Syllable Deletion
- b. mad^Yinda-n^Yu-nda "walk up with-dative subordinate"
 mad^Yinda-n^Yu:-nda Penultimate Lengthening
 mad^Yinda-n^Yu:-n Final Syllable Deletion

Actually, a fair number of stems do undergo the rule, as in /gindanu/ "moon" → ginda:nu → ginda:n. The evidence for the underlying stem final vowel is found when a suffix is added, as in the ergative gindanu-ŋgu. Not all stems that meet the phonological requirements undergo reduction: cf. /mulari/ "initiated man" → mula:ri, not *mula:r. Since it isn't predictable whether a stem will reduce or not, we will mark this information in the lexicon with the diacritic [+R] (= Reducible), restating Final Syllable Deletion as follows:

$$(14) \quad (C)V \xrightarrow{\langle +R \rangle_a} \emptyset / \#(C_oVC_oV)_o \langle + \rangle_b C __\#$$

condition: a or b

The diacritic [+R] serves the same function as Dixon's "morphophonemes" /A/, /I/, and /U/--the change is made simply to make the rule statable in standard formalism.

With this rule in mind, let us examine some of the rule orderings that Dixon posits for his system. For the moment, we will assume for the purposes of the argument that Dixon's

formulation of Illicit Length Elimination is the correct one. First, it can be shown that Illicit Length Elimination must apply before Final Syllable Deletion, as under Dixon's formulation the former rule is sensitive to the underlying number of syllables in the word, rather than the number found after Final Syllable Deletion applies. An example of this is (15):

- (15) barganda-d^Yi-n^Yu
- a. barganda:-d^Yi:-n^Yu lengthening rules
 barganda:-d^Yi:-n^Y Final Syllable Deletion
 *--- Illicit Length Elimination
- b. barganda:-d^Yi:-n^Yu lengthening rules
 barganda-d^Yi:-n^Yu Illicit Length Elimination
 barganda-d^Yi:-n^Y Final Syllable Deletion

In addition, we can say that Yotic Deletion must follow Final Syllable Deletion, since the latter rule may be blocked by /y/'s that Yotic Deletion later eliminates:

- (16) galbiy-ni "catfish-genitive"
- galbi:y-ni Penultimate Lengthening
- g albi:y-n i Final Syllable Deletion--
 | | | | | blocked
 (C_oVC_oV)_o+C_o_____
- galbi:ni Yotic Deletion

Compare this with the derivation of /mabi-ni/ "tree kangaroo-gen.", in which there is no /y/ present to block deletion:

(17)	mabi:-ni	Penultimate Lengthening
	m ab i: - n i	Final Syllable Deletion
	(C _o VC _o V) _o + C	
	→ mabi:-n	

If the /y/ in galbi:y-ni deleted before Final Syllable Deletion, we would expect a parallel result, namely *galbi:n.

Another argument for this rule ordering shows that Final Syllable Deletion must also feed Yotic Deletion in certain cases, as well as not being bled by it:

(18)	mabi-yi	"tree kangaroo-comitative"
	mabi:-yi	Penultimate Lengthening
	mabi:-y	Final Syllable Deletion
	mabi:	Yotic Deletion

Our final ordering argument shows that Illicit Length Elimination must follow Yotic Deletion:

(19)	guriliy	"black nose wallaby-abs."
	guri:liy	Penultimate Lengthening
	guri:li:	Yotic Deletion
	guri:li	Illicit Length Elimination

If the opposite order obtained, we would get a final long vowel.

The reader who has kept all this in mind so far will realize that we have just demonstrated an ordering paradox, viz.:

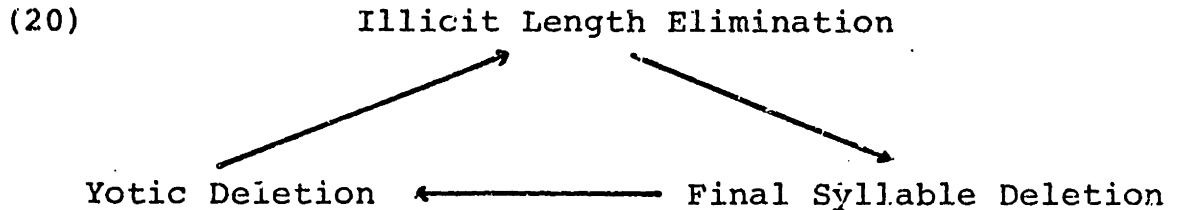

Dixon claims that the paradox isn't an argument against his analysis, arguing that since Illicit Length Elimination embodies a surface-true generalization about Yidin^y word structure, it should be allowed to apply throughout the phonological derivation, or at least at the beginning and end of it. However, this cannot be held to be a privilege of surface true rules in general. For example, we often find cases in which rules introduce new syllables into a representation in order to conform to surface canonical patterns, thereby rendering a preceding stress rule opaque. This is found in Hebrew (Prince 1975), Macassarese (Chap. 3, p. 120), and English (Chapter 5, Section 7). If these rules were allowed to apply anywhere, stress would fall on the wrong syllable. Given the premise that a theory in which rules must be ordered transitively makes stronger claims about language, we must regard the ordering paradox as evidence against Dixon's statement of the rules.

The paradox arises from Dixon's suspect formulation of the Illicit Length Elimination rule: it has to precede Final

Syllable Deletion only because it has been made sensitive to the underlying syllable count of the word. But as we have seen, this isn't necessary: the crucial information is also present in the stress, which falls on even syllables whenever the word has an odd number of syllables in underlying representation. If we state Illicit Length Elimination as a rule shortening stressless vowels, we eliminate the ordering paradox, since Illicit Length Elimination no longer has to precede Final Syllable Deletion. This argument bolsters our claim concerning Illicit Length Elimination, which is already strongly supported by the more natural expression of the rule it affords.

We can't claim to be finished though, since even with our revision, there are still three rules which refer to an alternating syllable count: stress, Penultimate Lengthening, and Final Syllable Deletion. The "alternating count" in the latter two is implicit in any procedure that determines whether a word has an odd or even number of syllables--an odd syllabled word, after all, is just a word in which a syllable is left over after syllables have been counted off in pairs. In addition, at least four minor segmental alternations refer crucially to the odd-even count (for discussion see GY, pp. 128, 142). Rules that delete or modify segments based on whether a word has an odd or even number of syllables are not especially common--it would be a colossal coincidence to find six of them in a single language if all applied on an independent basis, particularly when the

language in question has an alternating stress pattern. To explain how a language could have such a cluster of rules, it is best to provide a single basis for counting off syllables which can feed into all of the relevant rules, rather than counting syllables for each rule separately. It turns out that the metrical structures needed to account for Yidin^y stress can provide this basis quite easily. The analysis that follows could be varied in some of its details, but any of the plausible variants will accomplish the main task of capturing the common basis of the rules that refer to syllable count.

I propose that metrical structure in Yidin^y is created by the following rule:

- (21)a. Going from left to right, form quantity insensitive, binary feet with right nodes dominant.
 b. Form a left dominant word tree.

Some examples are the following:

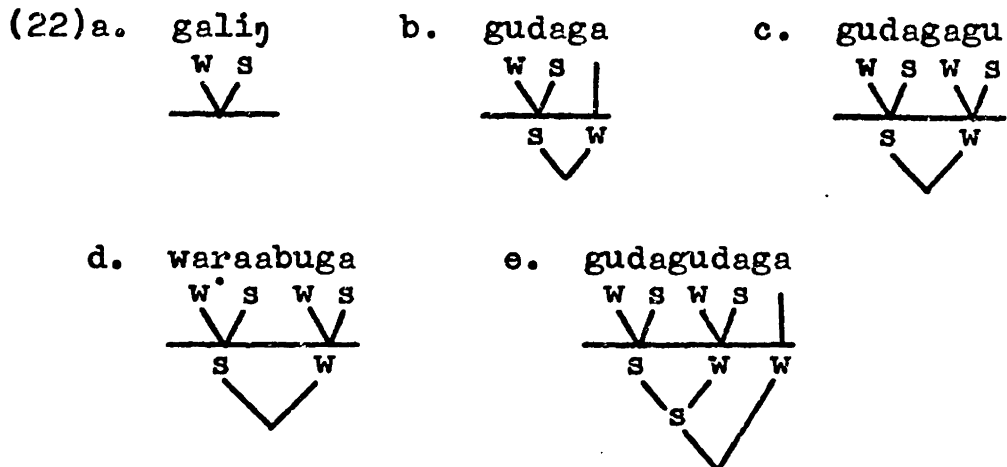

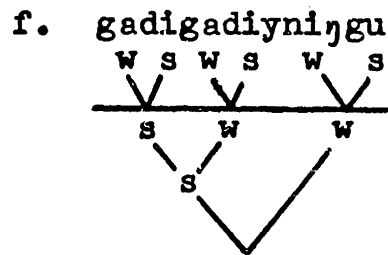

Several features of these rules require comment. The labeling of the feet as w s is obviously preliminary, and is often revised later in the derivation. It isn't absolutely necessary for the feet to be labeled at this stage. However, under my schema for stress rules, a rule of tree construction must specify either right or left nodes as dominant, and certain advantages in fact accrue from making right nodes strong early in the derivation.

The geometry of the word tree, which makes the left-most stress the strongest, is supported by impressionistic and acoustic observations by David Nash (personal communication). Dixon does not mention any distinctions of prominence among the stresses. If his implicit claim that such distinctions are absent is correct, then we would eliminate the word tree rule from (21), and complicate slightly the rules that follow. In view of this uncertainty, I will continue to mark syllables only as stressed or unstressed, without making further distinctions among them.

I have adhered to the standard practice of this thesis in representing long vowels as geminate in (22)d waraabuga-- there is no evidence that would militate against such an analysis, and it has the advantage of allowing us to

represent pre-lengthening suffixes such as -:d^yi and -:ri as -Vd^yi and -Vri, with an unspecified vowel that assimilates to its left neighbor. Further, in fast speech /iyi/ is often heard as /i:/, again suggesting a geminate interpretation.

The degenerate final feet in odd-syllabled words, such as (22)b and e, must be eliminated, since the final syllables of such words aren't stressed on the surface. This can be done either by positing a rule deleting non-branching feet, or by placing a constraint on foot construction to the effect that all feet it creates must branch. In either event, the revised structures for (22)b and e will be:

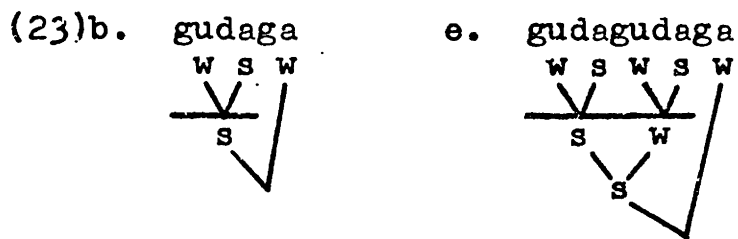

The word final syllables will not be adjoined to their adjacent feet, since as right nodes they would not satisfy the constraint on Stray Syllable Adjunction requiring that adjoined nodes be recessive.

Once the metrical structure has been created, there is no need for any further rules to count up syllables, since the information needed is already present in the tree. For example, Penultimate Lengthening can now be expressed as a rule lengthening strong penults, as in (24):

$$(24) \quad V \rightarrow VV / \begin{array}{c} s \\ | \\ \underline{\quad} \end{array} \sigma \#$$

where σ stands for a syllable. It will apply only in odd syllabled words, since only these words have penultimate stress at this level of the derivation. Examples are:

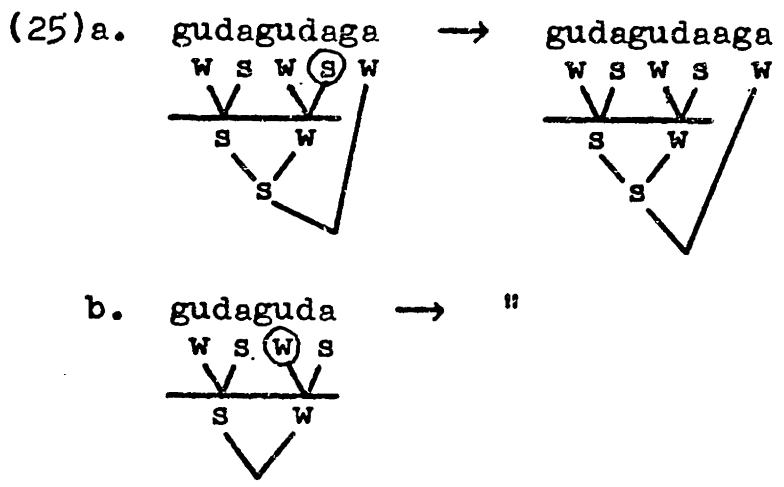

There is a problem with the formulation of (24), in that it would incorrectly lengthen underlying VV to VVVV. This seems to be part of a general problem with vowel lengthening rules in a system where long vowels are counted as geminate-- typically lengthening rules display the pattern $V \rightarrow VV$, $VV \rightarrow VV$ rather than $V \rightarrow VV$, $VV \rightarrow VVVV$. In the present case, we can again invoke McCarthy's claim that phonological rules apply only if their output can be syllabified according to the canonical pattern of the language. If this is so, underlying VV could not be converted into VVVV since canonical Yidin^y syllables may not contain VVVV sequences. In such cases, Penultimate Lengthening would be blocked,

leaving the long vowels as VV.

The metrical theory also provides a simple account for Final Syllable Deletion:

$$(26) \quad (C) \begin{matrix} V \\ \langle +R \rangle \end{matrix} \rightarrow \emptyset \langle + \rangle_b \begin{matrix} W \\ | \\ C _ \# \end{matrix}$$

condition: a or b

Some examples are:

(27) "go up-past"

"walk up-dative subordinate"

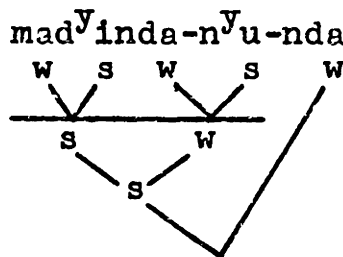
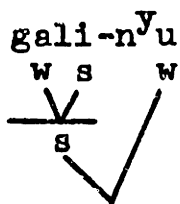

formation of metrical structure

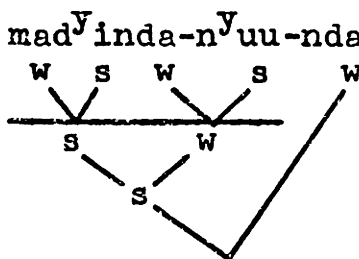
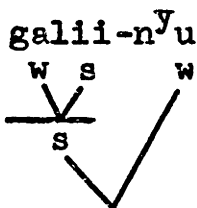

Penultimate Lengthening

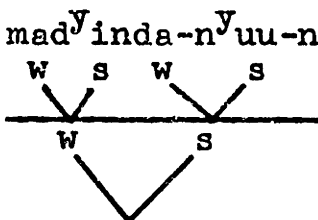
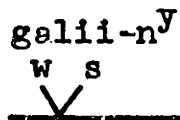

Final Syllable Deletion

It should be noted that in addition to simplifying the rules of Penultimate Lengthening and Final Syllable Deletion, the metrical theory has made them more phonetically

natural as well, since lengthening of stressed syllables and deletion of stressless ones is quite common. The various minor segmental rules that Dixon claims are sensitive to syllable count can similarly be made sensitive to local properties of the metrical tree. As numerous accounts are available, I will not formalize these rules here.

The next rule in the ordering after Final Syllable Deletion is Yotic Deletion, which will require further discussion. This rule, it will be recalled, maps /iy/ and /iiy/ onto /i/ and /ii/ in the following way:

$$(28) \quad \left\{ \begin{array}{l} iy \rightarrow i \\ iiy \rightarrow ii \end{array} \right\} / \underline{\quad}^c$$

$$\left\{ \begin{array}{l} iy \\ iiy \end{array} \right\} \rightarrow ii / \underline{\quad}^\#$$

In a representation in which long vowels are phonologically geminate, we might write this rule as (29):

$$(29) \quad iy \rightarrow \langle i \rangle i / \underline{\quad}]_\$ \langle \# \rangle$$

However, there is some evidence for a different formulation. Dixon observes that when final /iy/ occurs in an even syllable before the stress neutral enclitic -(a)la "now," the /i/ lengthens, but the /y/ doesn't delete:

$$(30) \quad \text{galbiy\#ala} \rightarrow \text{galbi:y\#ala} \quad \text{"catfish-abs.-now"}$$

This suggests that lengthening of /i/ before y# and deletion

of syllable final /y/ are separate processes:

- (31)a. $i \rightarrow ii / __y\#$
 b. $y \rightarrow \emptyset / i___]_\$$

The /y/ deletion rule would apply only above the level of the phonological word (perhaps at the level of the grammatical word, which may contain several phonological words in Yidin^y). The non-deletion of /y/ in (30) would then follow, assuming that syllabification may take place across internal word boundaries. The revised analysis obviates the need for a special /y/ insertion rule in these cases (GY p. 97).⁵

Once all the rules introducing length have applied, the feet may be labeled in their final form, as in (32):

- (32) On the [+syl] projection, relabel all the feet such that dominant nodes are strong iff a dominant node of any foot branches.

Some examples of relabeling are the following:

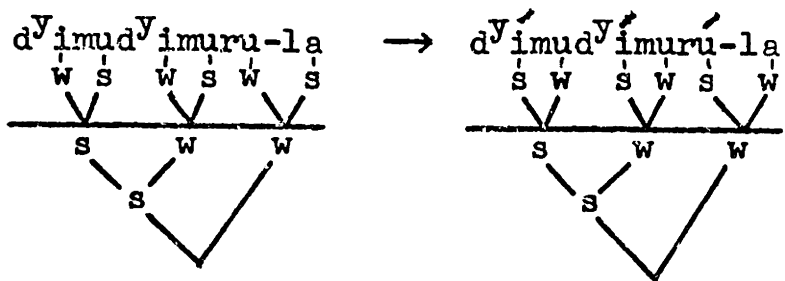
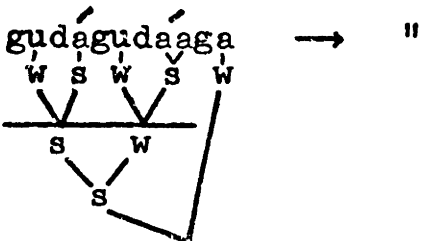
- (33)a.  $d^y i m u d^y i m u r u - l a$ \rightarrow $d^y i m u d^y i m u r u - l a$ "houses-locative"
- b.  $g u d a g u d a a g a$ \rightarrow "

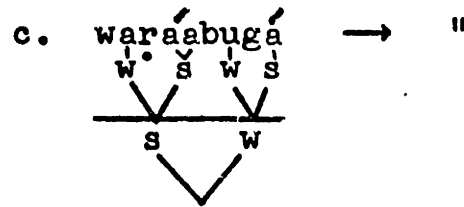

Rule (32) clearly has the effect of (9), stressing even syllables iff there is an even syllable with a long vowel. But the teleology of the rule is a mystery: it is phonetically natural for stress to be retracted off of short vowels, but we don't understand why all of the feet should retain iambic labeling if just one of them is forced to by its long vowel. I would speculate that the "purpose" of the rule is to retract stress off of final vowels, subject to two fairly natural provisions: that no stress clashes (i.e. sequences of two strong syllables) may be formed, and that no branching dominant nodes may be labeled weak. We might then formulate the rule as in (34):

$$(34) \quad \begin{array}{c} F \\ \wedge \\ w \quad s \end{array} \rightarrow \begin{array}{c} F \\ \wedge \\ s \quad w \end{array} / \text{---} \left\{ \begin{array}{c} \# \\ s \end{array} \right\}$$

Condition: may not apply if the output contains a dominant node that branches on the [+syl] projection.

Some examples are:

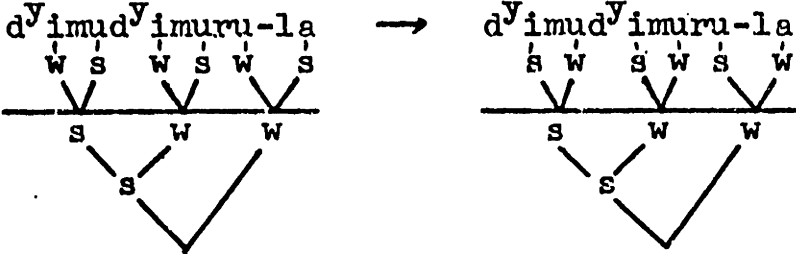
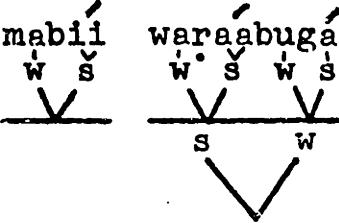
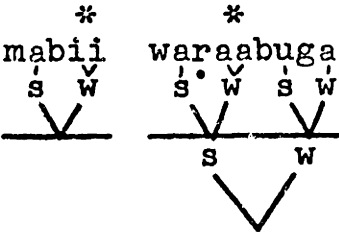
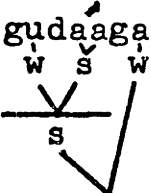
- (35)a. 
- b.  cannot apply; would produce 
- c.  cannot apply; no word final foot

There is a bit of evidence suggesting that this is right: the clitic -#(a)la "now" may optionally be integrated into the stress pattern of the word to which it is adjoined (GY, p. 97). If the latter is even syllabled we get even syllable stress:

- (36) gálijáln^yu#lá "go-comitative-past-now"
 OR gálijáln^yúla

Notice that the shift of stress to even syllables occurs even though there are no long vowels--Penultimate Lengthening does not apply above the word level. However, we don't

need a long vowel to explain the stress shift: if the stress rules are allowed to reapply optionally above the word level, the observed stress pattern is derived:

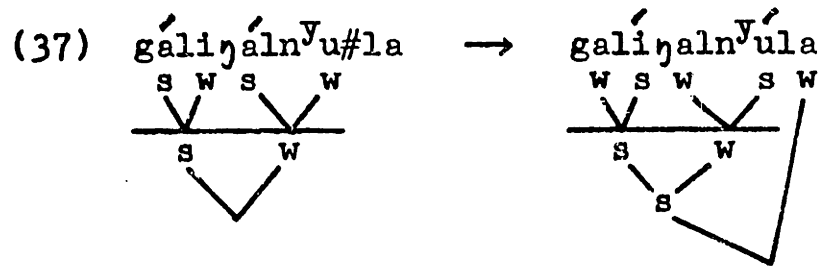

The rightmost foot will not be relabeled s w by (34), since it isn't word final.

Once stress has been settled in the right place, we can shorten all the unstressed vowels, as we proposed earlier. Stated metrically, the rule takes the form (38):

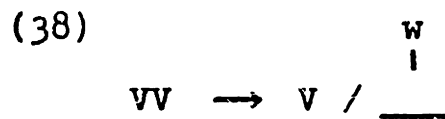

Examples are

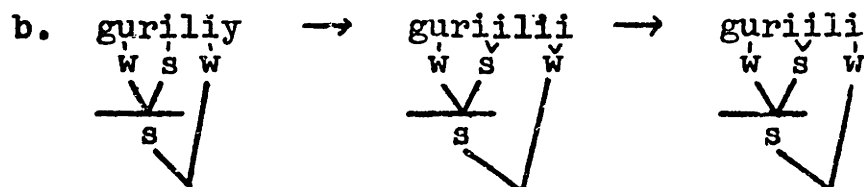
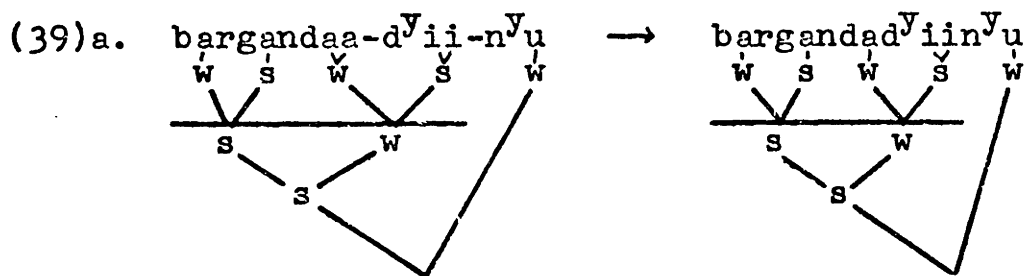

This concludes our revision of Yidin^Y phonology. We have seen that the stress pattern requires a new sort of labeling rule, which has the effect of assimilating the labeling of the feet to one another. However, the analysis has the great advantage of capturing the common basis of the many rules which must refer to syllable count. It is interesting that the metrical feet needed to make the analysis work are perceived intuitively by Dixon himself:

- (40) Yidin^Y plainly prefers each word to contain a whole number of disyllabic stress units (all of the type S(tressed)-U(nstressed), or of the type US). (GY, p. 41)

The metrical analysis formalizes this intuition, and justifies it by providing a simplified analysis of the various rules that crucially refers to the "disyllabic units," a.k.a. metrical feet.

It is also enlightening to see how the analysis might be carried out using a segmental stress feature. The effect of foot construction could be approximated by an iterative rule such as (41):

$$(41) \quad V \rightarrow [+stress] / \left\{ \begin{array}{c} \# \\ V \\ [+stress] \end{array} \right\} C_0 V C_0 \text{---}$$

Penultimate Lengthening and Final Syllable Deletion could then be stated as lengthening or deleting

$\begin{bmatrix} V \\ +\text{stress} \end{bmatrix}$ and $\begin{bmatrix} V \\ -\text{stress} \end{bmatrix}$ respectively, with a parallel

approach taken for the minor segmental rules. However, when the time came to place stress in its proper final position, we would need a rule like (4):

$$(42) \quad C_0 \quad V \quad C_0 \quad \begin{bmatrix} V \\ +\text{stress} \\ -\text{long} \end{bmatrix} \rightarrow \begin{matrix} [+str] & [-str] \\ 1 & 2 & 3 & 4 \end{matrix}$$

1 2 3 4

$$/ \#(C_0VC_0 \begin{bmatrix} V \\ -\text{long} \end{bmatrix})_0 \text{---} (C_0VC_0 \begin{bmatrix} V \\ -\text{long} \end{bmatrix})_0 C_0 \#$$

Rule (42) is not only complex, but also misses a generalization, since it doesn't explain why the assignment of stress to the odd vowels should be accompanied by removal of stress from the even vowels. Under a metrical theory, where stress is a relative matter, this is automatic.

My proposals are not the first metrical account of Yidin^y phonology. I will discuss here briefly the analysis of Nash (1979). Nash's ingenious proposal is more ambitious than mine, in that it attempts to predict all vowel length from the stress pattern, rather than vice versa. The basic metrical rule is the following (Nash 1979, p. 116):

- (43)a. From (N.B.) right to left, pair syllables into binary feet (labeled s w).
- b. If the first foot branches, group the feet into a left branching word tree. Otherwise, group

the feet into a right branching word tree.

The rule produces the contrasting metrical structures of (44):

(44)a. η una[́]ra[́]ra- η gu "whale-ergative"

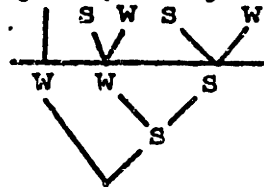

b. d^yimud^yimurú-la "houses-locative"

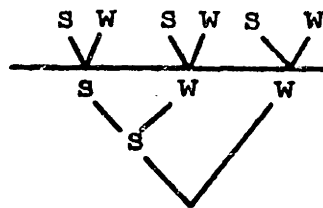

Notice that in (44)a we would expect penultimate main stress. This prediction is corrected, at least to the point where the murky data can indicate, by a rule to be described later.

Using these trees, Penultimate Lengthening can be stated as lengthening the strongest vowel of the word, provided it isn't initial, as in (45):

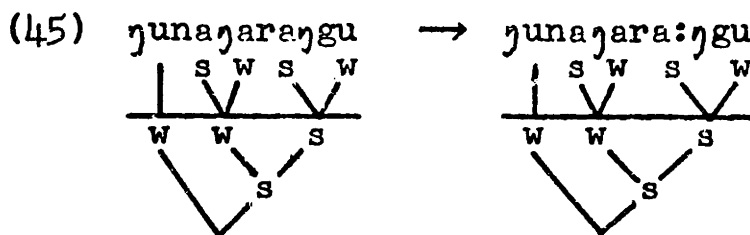

Nash doesn't formalize Final Vowel Deletion, but the right results obtain if it is restricted to apply only in strong final feet.

The long vowels that in Dixon's system are underlying

or derived from iy# are accounted for in Nash's rules by forming aberrant metrical trees, constructed so that the vowel in question will be the strongest syllable of the word, as in (46):

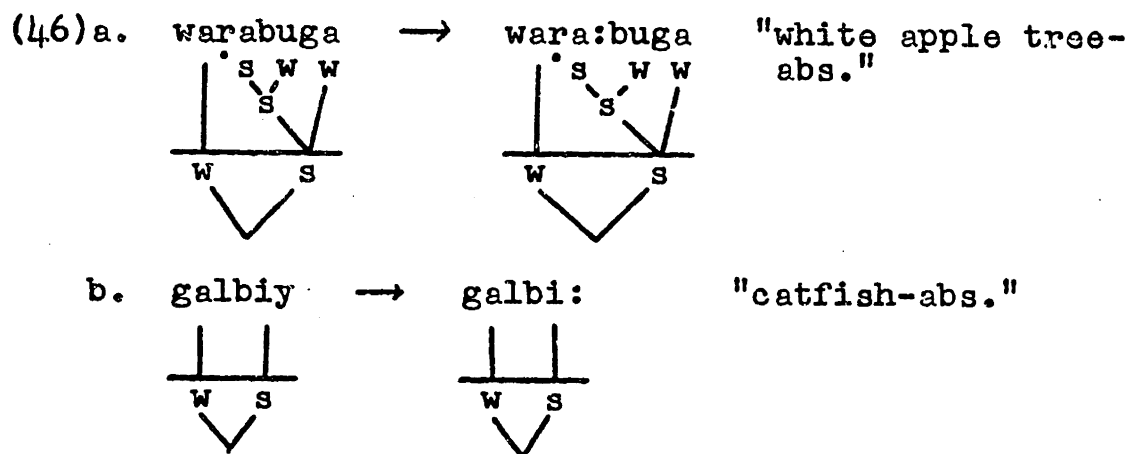

The long vowels result from the rule lengthening the strongest vowel of the word. Notice that (46)a predicts that there will be no secondary stress on the final syllable of wara:buga. This contradicts Dixon's specification of the stress pattern, although the explicit datum needed to refute Nash's claim is not found in Dixon's grammar.

Nash's analysis encounters more difficulties in handling the suffixes that induce length on the preceding syllable. It will be recalled that this length shows up on the surface only in stressed syllables (cf. bargánda:-d^yi':-n^yu → bargánda^yi':n^y). In Nash's system this is handled by restricting the morphological lengthening rule to apply only to strong syllables, as in (47):

$$(47) \quad V \rightarrow [+long] / \underset{\substack{| \\ s}}{\text{---}} C_0 \left[\begin{array}{l} \text{Suffix} \\ +\text{Pre-Lengthening} \end{array} \right]$$

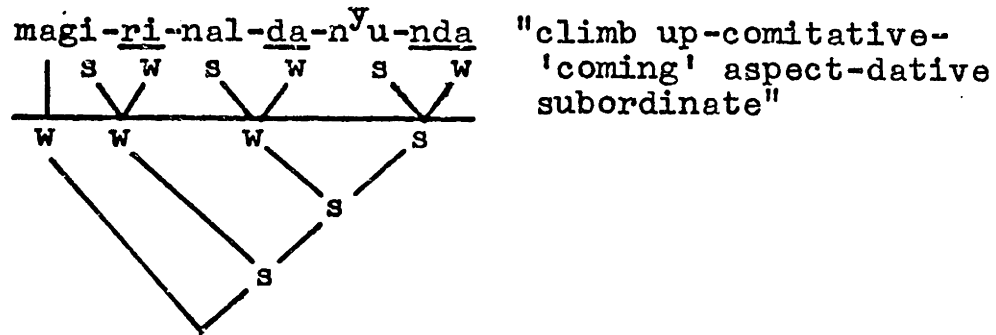

→ magi:-ri-na:l-da-n^yu:-n

Unfortunately, the stress rules don't always put the stress where this will work. In particular, words like wawa:-d^yi-n^yu "see-antipassive-past" are derived incorrectly:

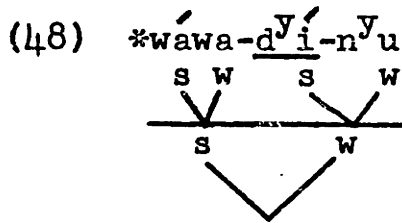

The pre-suffixal lengthening rule won't apply to (48), since the pre-suffixal vowel isn't stressed. To fix this up, Nash must complicate the foot labeling rule in the following way:

- (49) Feet are labeled *s w*, except that they are all labeled *w s* throughout a word in which an irregular (i.e. pre-lengthening--BH) affix begins any foot and no consecutive *w w* syllables result.

Applied to wawa-d^yi-n^yu this produces

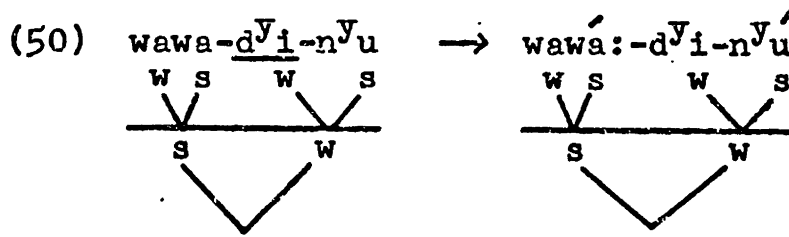

Notice that the stressing predicted here differs from that assigned to the phonetically parallel wara:buga under (46)a. The provision in Nash's rule prohibiting w w sequences is intended to prevent words like barganda-d^yi-n^yu from being labeled as in (51):

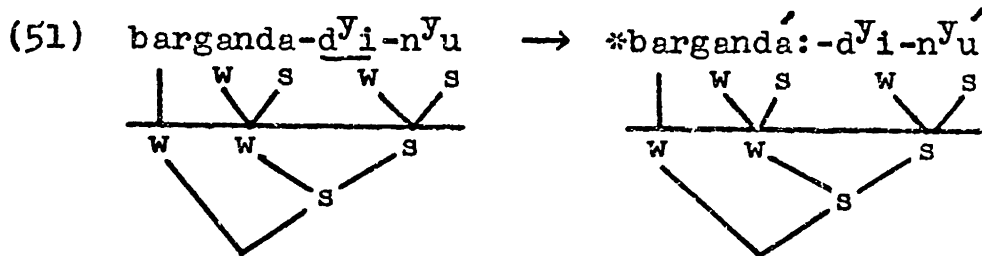

I will now present some reasons why my analysis might be preferred to Nash's. Note first that both analyses require unusual labeling rules which have the effect of labeling every one of the feet of the word iambic if just one foot has a certain property. However, in my analysis the relevant property is a natural one, in which long vowels attract stress, whereas Nash's rule must refer to a diacritically marked distinction, opposing the pre-lengthening suffixes to the others. Furthermore, Nash's analysis must refer to this distinction twice, in the labeling rule and again in the lengthening rule itself. Under my analysis the diacritic

distinction need be referred to only in the lengthening rule, with the stress derived by a rule that is independently needed to stress words with lexical long vowels and final iy#. Finally, the rule constructing the word tree in Nash's analysis appears to be unattested elsewhere; whereas my word tree rule is of a very common type.

Further arguments can be found in other parts of Yidin^y phonology. There is a late phonetic rule in Yidin^y that shifts stress from the second vowel of a word to the first, without regard to vowel length, as in bará:d^yiná → bára:d^yiná "punch-antipassive-purposive." The rule applies optionally, but according to Nash is the norm rather than the exception in connected speech. This is why it is difficult to find phonetic evidence against Nash's right branching word trees, as in (44)b. Nash's formulation of the stress fronting rule is as in (52):

$$(52) \quad \#w \wedge s \quad \rightarrow \quad s \wedge w$$

This will work in even-syllabled words like bára:d^yiná, as (53) shows:

$$(53) \quad \begin{array}{ccc} \text{bará:d}^y\text{iná} & \rightarrow & \text{bára:d}^y\text{iná} \\ \begin{array}{cc} w \cdot s & w \cdot s \\ \swarrow \quad \searrow & \swarrow \quad \searrow \\ s & \cdot w \end{array} & & \begin{array}{cc} s \cdot w & w \cdot s \\ \swarrow \quad \searrow & \swarrow \quad \searrow \\ s & \quad w \end{array} \end{array}$$

But the rule fails when it is applied to examples like gali:na "go-purposive":

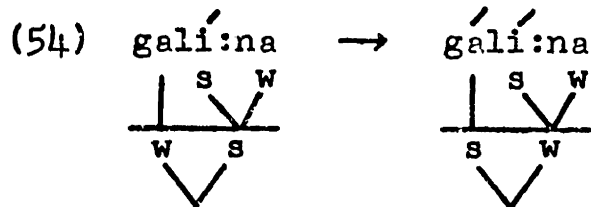

The rule places stress on the first syllable, but incorrectly fails to remove stress from the second. In order to derive the correct gali:na, an ad hoc rule of destressing would be needed. Under my system, however, a single straightforward rule is all that is needed:

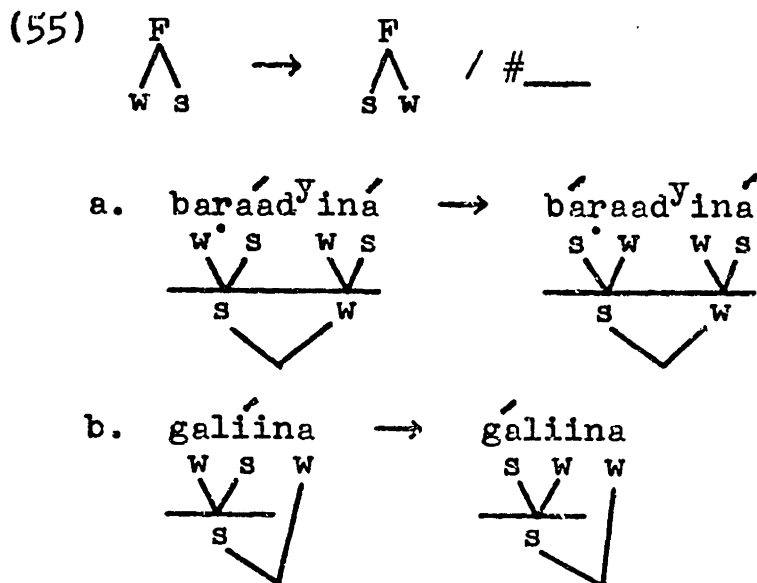

Because the feet are assigned from left to right, the domain of the rule will always be a foot.

A similar argument that the constituent structures assigned by my analysis are the correct ones follows from an observation of Dixon's:

- (56) When (informant) Dick Moses recorded a Yidin^y song, he missed exactly one disyllabic unit each time he took breath--this was either a complete word (the first bugu of búngu búngu yínal), or else the first two syllables of a trisyllabic word (bugu from bugú:ba d^yúndulúbi d^yánaŋ). (GY, p. 41)

Dixon's observation makes sense only if the constituent structure for trisyllabic words is as my analysis rather than Nash's predicts:

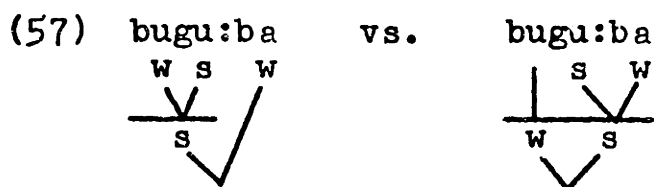

Under my analysis, we can say that what Moses left out was simply a foot, rather than the arbitrary designation "two syllables." We conclude from these facts that Nash's analysis makes too many wrong empirical predictions to be tenable, and should be rejected in favor of my analysis or a better one.

4. Conclusion

What do the cases presented in this chapter tell us about labeling rules? First, it seems that the range of freedom for labeling rules is fairly large: rules may refer to various criteria of branching, various conditions on the nodes being labeled (including morphological ones), and

external conditions such as that found in rhythm rules and the foot labeling rule of Yidin^Y. But it is clear that some rules are more highly valued than others: for example, branching nodes obviously attract strong labeling, so that we would be surprised to find a rule that labeled dominant nodes strong iff they do not branch, or iff their sister recessive nodes do branch. Further, it seems that at least among the feet, dominant nodes tend to attract stress, as is evidenced by two phenomena: the absence of feet (and possibly any trees) in which all recessive nodes are labeled strong, and the prevalence of the labeling convention "dominant nodes strong" over the convention "dominant nodes strong iff they branch." In addition, it is fairly clear that unmarked labeling rules avoid stress clashes, in some as yet undefined sense of the term. This claim is supported by the absence of feet (again, possibly trees) in which all recessive nodes are strong, by the Yidin^Y labeling rule, and by the existence of rhythm rules of various sorts in many languages. Finally, we can state with some confidence that the two least marked labeling conventions are dominant nodes strong, and dominant nodes strong iff they branch.

Footnotes to Chapter 4

¹This is in fact a Classical Arabic form, as it would be stressed by a Cairene speaker. Words of this pattern do not exist in the Cairene dialect, but the Cairene stress rule is productively extended to Classical words.

²Thanks to Alan Prince for pointing this out to me.

³This is not a surface form. The remainder of the derivation will be discussed later.

⁴Dixon actually specifies that C_i must be a possible word final, rather than syllable final consonant. It does no harm to use the latter designation, since the possible word final and syllable final consonants in Yidin^y are the same.

⁵If the revised analysis is correct, it also obliterates our ordering paradox argument against Dixon's version of Illicit Length Elimination. The rules may now be ordered as follows: $i \rightarrow ii / ____y\#$, Illicit Length Elimination, Final Vowel Deletion, $y \rightarrow \emptyset / ____]_\S$. However, since the other arguments against Dixon's formulation seem powerful enough, this is of little consequence.

Chapter 5: Where does English Fit In?

1. Introductory

Earlier in this thesis I have suggested that the rules of tree construction that are sensitive to quantity have only two options for the size of foot they may construct: binary and unbounded. Further, I have suggested that if a foot construction rule is sensitive to quantity, it allows only the dominant terminal node to branch. An obvious challenge for such a system is the stress system of English, which abounds in ternary feet, including ternary feet in which the rightmost recessive node is a branching rime. Such feet are found in English in both strong and weak positions, and both word finally and earlier in the word, as (1) shows:

(1)	detérioràte	Nébuchadnézzar	Américan
	héterodòx	pàraphernàlia	lábyrinth ¹

What I want to show here is that the optimum description of the English stress system not only doesn't need rules that construct ternary feet, but must in fact exclude such rules--that in fact every ternary foot that appears on the surface in English is the result of formal devices other than actual ternary foot construction. The devices that will be found to be necessary are (1) extrametricality; (2) destressing rules; (3) segmental rules applying after foot construction.

A few preliminaries are necessary here. I will assume

roughly the same taxonomy of vowels as that found in Halle (1977):

(2) Long

div <u>i</u> ne	p <u>ou</u> nce	B <u>er</u> muda	C <u>ata</u> wa
ob <u>sc</u> ene	m <u>oo</u> n	p <u>oi</u> nt	Ch <u>ic</u> ago
v <u>a</u> ne	v <u>o</u> te		

Short

p <u>i</u> t	p <u>u</u> t	imp <u>u</u> dent
p <u>e</u> t	p <u>u</u> tt	
p <u>a</u> t	p <u>o</u> t	

It isn't especially crucial what phonological system we assume underlies the vowels of (2); all that will be needed here is a set of underlying representations in which the long vowels contain two consecutive segments and the short vowels contain one. For concreteness I will assume the following underlying forms, in which vowel length has been expressed as gemination by our standard practice:

(3) Long

div <u>i</u> ne	/ii/	p <u>ou</u> nce	/uu/
ob <u>sc</u> ene	/ee/	m <u>oo</u> n	/oo/
v <u>a</u> ne	/æ æ /	v <u>o</u> te	/ɔ ₁ ɔ ₂ /
B <u>er</u> muda	/ʌ ₁ ʌ ₂ /	C <u>ata</u> wa	/ɔ ₂ ɔ ₃ /
p <u>oi</u> nt	/ɔ ₂ i /	Ch <u>ic</u> ago	/aa/

Short

<u>pit</u>	/i/	<u>put</u>	/u/	imp <u>udent</u>	/ɛ/
<u>pet</u>	/e/	<u>putt</u>	/ʌ/		
<u>pat</u>	/æ/	<u>pot</u>	/ɔ _ɛ /		

The correct surface forms are obtained by applying Vowel Shift and Backness Adjustment to all tense vowels (N.B. all non-low short vowels are lax); inserting /y/ before /ɛ/ and rounding it (optionally, if it is short); and unrounding /ɔ_ɛ/. In the examples that follow, I will primarily use orthography rather than the representations of (3) in order to increase legibility.

We will assume here the following syllable divisions for English. Sequences of the form VCV will be syllabified in the unmarked way, i.e. V.CV, at least at the point in the derivation at which the stress rules apply. For discussion of possible later resyllabification, see Kahn (1976), Selkirk (ms. a). Sequences of the form (4):

$$(4) \quad V \text{ obstruent } \left\{ \begin{array}{l} \text{liquid} \\ \text{glide} \end{array} \right\} V$$

will be divided after the initial vowel, as suggested in Chapter 1. The evidence for this, it will be recalled, is that the various phonological rules of English that are sensitive to the distinction between open and closed syllables all treat the first syllable of (4) as open. Sequences of the form (5):

(5) V s obstruent $\left(\left\{ \begin{array}{l} \text{liquid} \\ \text{glide} \end{array} \right\} \right) V$

are more controversial. Kahn (1976) claims that they are always syllabified so that everything after the first vowel falls in the second syllable, citing such stressings as órchestra, pédestal, and sácristan. However, the great majority of words ending in V s [-son] $\check{V} C_0 \#$ in fact have penultimate stress, which suggests that Kahn's examples might attest an aberrant, lexically marked syllable division. The same pattern is found among the other rules of English that are sensitive to open syllables. For example, a rule discussed below which destresses medial open syllables in weak position typically treats /s/ before an obstruent as closing its syllable: cf. infestation, detestation, elasti-
city. One can make a similar argument from the gap in the distribution of the triphthong /yuw/ in English: by and large, this vowel is found in a non-final syllable only if it is open, as in futile, cupric, putrid. Orthographic u in closed non-final syllables is generally pronounced /ʌ/, as in buxom, ductile, sumptuous. Without taking a stand on whether this is due to a phonological rule or a lexical redundancy rule, we note that /s/'s occurring before obstruents generally behave here as if they closed the preceding syllable: cases like rustic, musket, custard are far more common than cases like eustachian. Again, the facts suggest that V . s obstruent V syllable divisions are the exceptional case.

Kahn's best argument lies in his claim that initial weak syllables in words beginning with #C₀Vs [-son]V are regularly destressed, which is the normal case for open, but not closed syllables in this position. However, numerous examples from Kenyon and Knott (1948) such as m[æ]stítis, [ɔ̃]sténsible, pl [æ]stícitý, p[ɛ]stíferous, m[æ]scára, m[ɛ]stízo, M[ʌ]skógee suggest that the regularity of destressing in this position is a peculiarity of Kahn's own dialect. I find that in my own speech, many words undergo Destressing optionally, as in n[æ, ɔ̃]stúrtium, [æ, ɔ̃]stýanax, [ɛ, ɔ̃]scút-cheon. This variation suggests that we may be observing a sound change in progress, a recently introduced rule that resyllabifies /s/ when it occurs at the end of a weak initial syllable. Since this rule must be ordered after the stress rules, and since none of the other arguments concerning syllable division appear to be affected by the change, we are still free to assume that /s/ before an obstruent normally closes its syllable for purposes of stress assignment.

We will assume the following procedure for constructing the word tree in English. As we will see later, the word tree must always be right branching, unless a left branching tree results from cyclic rule application: word tree structure left over from earlier cycles is simply joined up with feet created on the current cycle (see Kiparsky 1979). The conventions for labeling the tree were discussed in part in the preceding chapter. They are stated more fully as follows, roughly in the form provided by Liberman and Prince (1977):

- (6) In the configuration $N_1 N_2$, label the dominant node N_2 as strong iff

a. It branches:

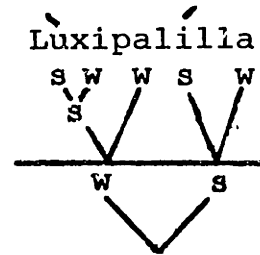
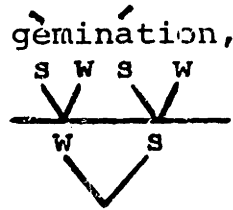

- b. N_1 dominates a non-branching rime, and N_2 doesn't dominate a suffix:

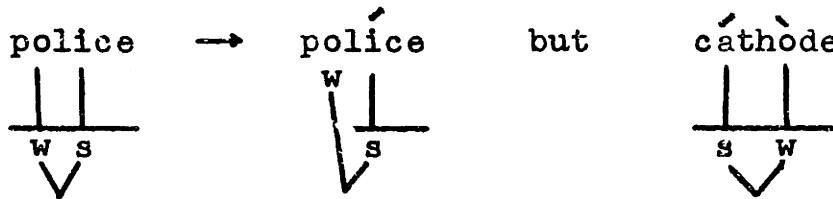

- c. The tree dominates a verb or adjective, N_1 doesn't branch, and N_2 doesn't dominate -ate or -ize:

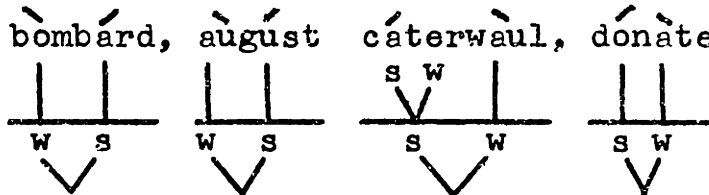

- d. The tree dominates a verb, N_2 dominates

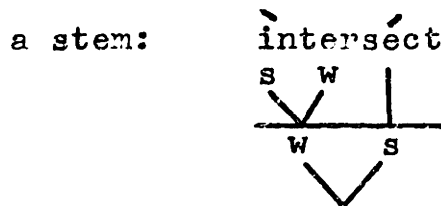

In addition to these labeling rules, I assume a set of diacritics to allow for the labeling of exceptional cases. These include nouns with strong but non-branching final feet

(Tennessee, Kalamazoo); bisyllabic words which have non-branching initial rimes but get initial stress anyway (rabbi, Kellogg); and, quite rarely, words with weak final branching feet (Ladefoged, pomegranate).

A final matter that must be addressed here is the question of how productive the English stress rules are. It is quite possible that English words are in fact listed in the lexicon already stressed (i.e. already having metrical structure), rather than having their stress derived after they are inserted in surface structure. Some evidence for this lies in the fact that word formation rules are often sensitive to the stress of their input words. This appears to be true both for rules of word-boundary affixation (Aronoff 1976) and for rules that attach morpheme boundary affixes (Strauss 1979). The rules that follow thus might be regarded in a sense as lexical redundancy rules, despite their rather derivational appearance.

To say that English stress is listed in the lexicon, however, is not to deny that speakers of English have extensive knowledge of the English stress pattern. The situation seems to be that the English stress rules define the maximum distance to the left that stress may be assigned or retracted (i.e. the maximum size foot that may be constructed), without specifying that this maximum be reached. We thus get words like antenna, Mississippi, where the stress rules would predict antenna, Mississippi. A proposal to handle these cases will be made shortly. That native speakers recognize and

obey the maximum is exemplified nicely by the pronunciation of Russian words such as bábushka, Nínotchka as babúshka, Ninóтчka by any English speaker who knows them but is sufficiently ignorant of Russian. In general, words of the form $X_0 \acute{X} \overset{\circ}{H} \overset{\circ}{X}$, where H is a heavy syllable, are fairly systematically excluded from English,² a result which will follow from the rules to be presented here.

2. Extrametricality Rules in English

With these preliminaries out of the way, we can now examine in detail some of the stress placement phenomena of English. One of the problems for the theory of syllable weight proposed here is the stress behavior displayed by English verbs and a large number of adjectives. These words receive final stress if they end in a string of at least two consonants or with a syllable having a long vowel, and otherwise penultimate stress, as in (4):

(1)	obéy	tormént	astónish
	atóne	usúrp	devélop
	divíne	robúst	cómmon
	discreét	ovért	illícit

This is due to the historical application of a more natural, Latin-like stress rule, followed by the loss of inflectional endings, with the position of the stress remaining the same. The criterion for when a final rime receives stress is thus not simply that of whether it is branching or non-branching: under our system, the final rime of edit[^] counts as branching

just as much as the final rime of divest.³ However, a simple adjustment will make the proposed branching criterion work: suppose that in all English words, final consonants are extrametrical. This can be accomplished by a rule like (2):

(2) Consonant Extrametricality

$C \rightarrow [+ex] / ____]$

The stress pattern of the verbs and adjectives will then follow from an ordinary, unmarked quantity sensitive rule, such as (3):

(3) English Stress Rule

At the right edge of the word, form a binary foot on the rime projection, with the left node dominant.

Feet constructed by (3) are labeled by the unmarked convention, dominant nodes strong. We can now begin the derivations of the words of (4):

(4)	atone	usurp	develop	
	a ɔn	uu urp	e e op	Rime Projection
	a ɔ(n)	uu ur(p)	e e o(p)	Consonant Extrametricality
	a ɔ(n)	uu ur(p)	e e o(p)	English Stress Rule

The surface metrical structures for these words are then derived by additional foot construction, word tree construction, and destressing of initial syllables:

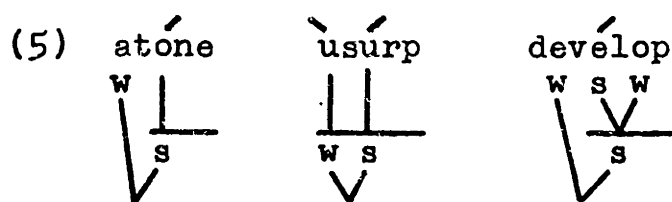

The stress pattern of nouns is somewhat different. In these words the final syllable always receives stress if it contains a long vowel:

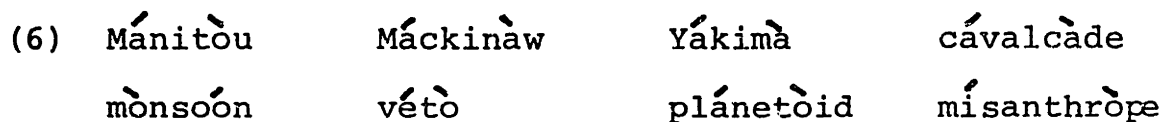

The final syllable also sometimes receives stress even if its vowel is short. Stressing of words of the latter type is lexically idiosyncratic, although tendencies can be discerned which are governed by the final consonant or consonants of the word (see Ross 1972).

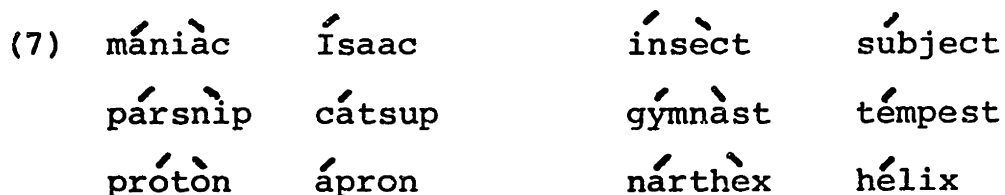

Generally, the final syllable is more likely to be stressed if it contains a consonant cluster or a non-coronal consonant in its rime. However, these are only tendencies, as (7) shows.

The stressing of long vowels will be accounted for here by a rule assigning a monosyllabic foot structure to rimes containing them:

- (8) On the [+syl] projection, construct a non-branching foot in which the dominant node (i.e. the only node) must branch.

Rule (8) applies quite generally, although its effects are sometimes eliminated on the surface by the application of destressing rules. I assume that final stress in words like those of (7) follows from their being represented prior to the application of the stress rules with a word final monosyllabic foot:

- (9) insect parsnip
 ┆ ┆
 ───┆ ───┆

The loose regularities in final stressing discovered by Ross can be accounted for by redundancy rules correlating the presence or absence of this final foot with the nature of the final consonant(s). Given the irregularity of the stressing of final syllables with lax vowels, a purely lexical solution seems to be the best one here.

When the final syllable of a noun is stressless, the situation is more regular. Generally, a heavy penult will receive stress in these cases, while the antepenult will receive stress if the penult is light:

- (10) América Arizóna agénda
 díscipline factótum appéndix
 lábyrinth elítist amálgam

These cases can be stressed by the same English Stress Rule as was postulated for verbs and monomorphemic adjectives, provided that we mark the final rimes of the nouns as extrametrical:

- (11) Noun Extrametricality
 $R \rightarrow [+ex] / _____]_N$

Rules (11) and (3) interact to stress labyrinth and Arizona as follows:

- (12) labyrinth Arizona Rime Projection
 | | | | | | | | | | |
- labyrin(th) Arizona Consonant Extrametricality
 | | | | | | | | | | |
- leby(rinth) Arizoo(na) Noun Extrametricality
 | | | | | | | | | | |

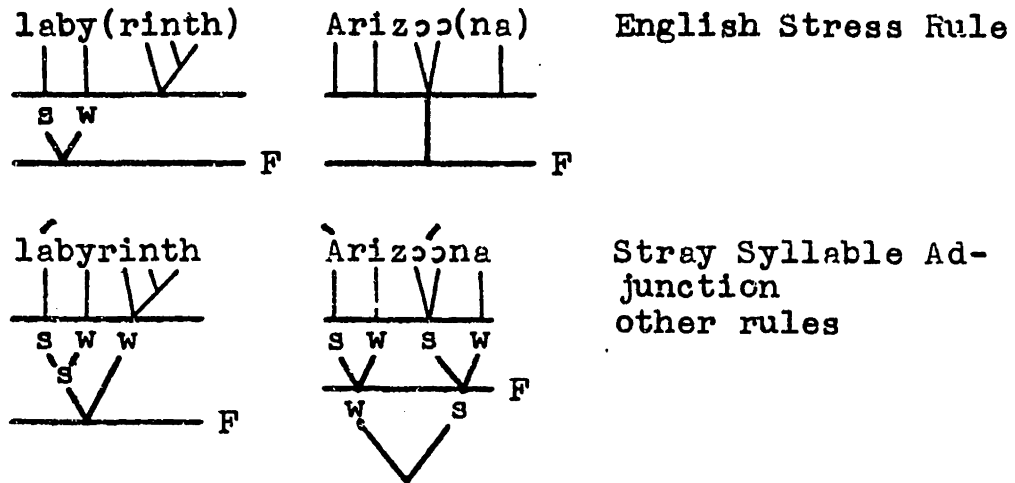

Notice also that when a word has a final monosyllabic foot underlyingly, it is still susceptible to the effects of Noun Extrametricality, as is shown by words like Merrimack, Adirondack:

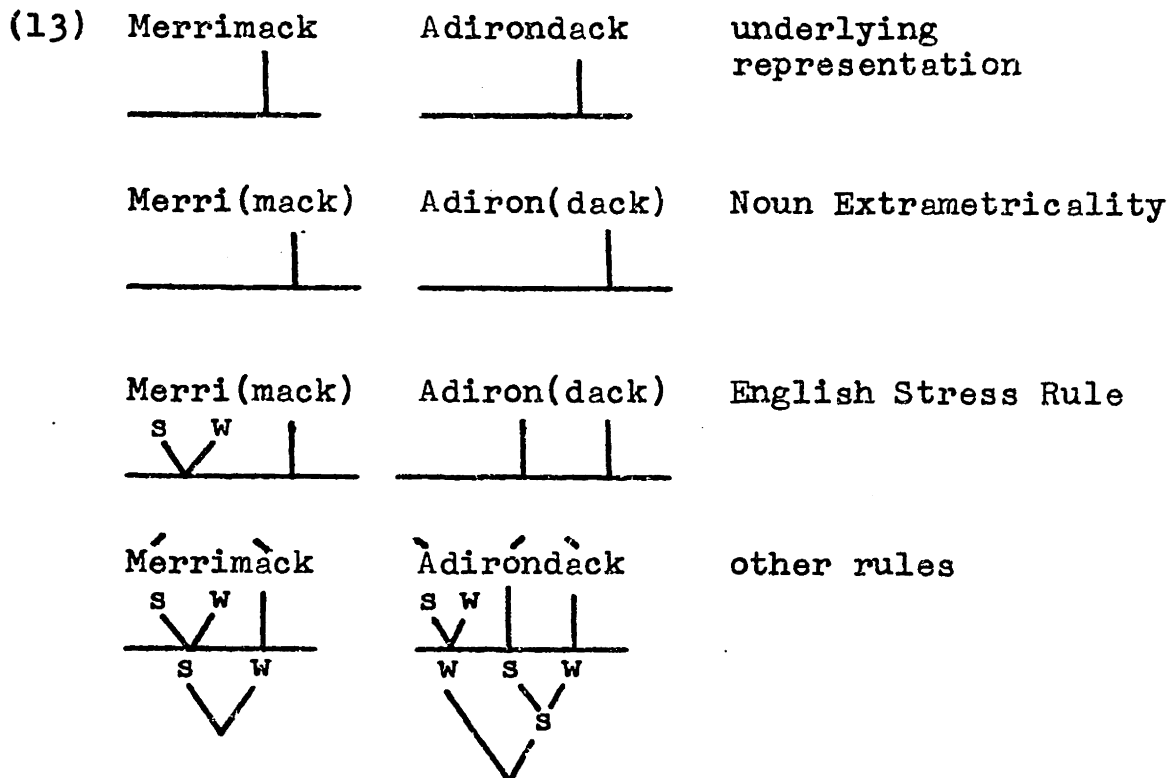

In some nouns, stress is not retracted back as far as the rules expressed so far would indicate:

- (14) persimmon Mississippí
 Kentúcky anténna

Such nouns could be handled in a number of ways: for example, we could make them exceptions to Noun Extrametricality; or we could assign their penultimate syllables the diacritic [+H] to make them honorarily heavy. Some evidence to bear on this question will be presented in Section 6.

Many adjectives follow the same pattern as the regular nouns. These adjectives typically end with suffixes such as -al, -ous, -ant, -ent, and -ive, as in (15):

- | | | | |
|------|-------------|-------------|------------|
| (15) | munícipal | adjectíval | fratérnal |
| | magnánimous | desírouis | treméndous |
| | signíficant | clairvóyant | relúctant |
| | innocent | complácent | depéndent |
| | prímítive | condúcrive | expénsive |

These contrast with the monomorphemic adjectives of (1), which are stressed according to the pattern of verbs. We can account for the difference with the following rule:

- (16) Adjective Extrametricality

$$R \rightarrow [+ex] / + ______]_A$$

The operation of Adjective Extrametricality is illustrated below:

(17)	magnani(mous)	reluc(tant)	Adjective Extrametricality
	magnani(mous)	reluc(tant)	English Stress Rule
	magnanimous	reluctant	Stray Syllable Adjunction
	magnánimous	reluctant	other rules

There are two adjectival suffixes which are exceptions to Adjective Extrametricality: -ic and -id. Adjectives formed by these suffixes receive penultimate stress, as follows:

(18)	intrepi(d)	economi(c)	Consonant Extrametricality
	---	---	Adjective Extrametricality
	intrepi(d)	economi(c)	English Stress Rule
	intrépid	éconómic	other rules

The overall picture here is one of lexical idiosyncrasy in the behavior of final syllables, but rigid constraint on how far back stress may be placed in non-final syllables and in the stressing of long vowels. Final syllables are marked for whether or not they have a non-branching final foot, and for whether they are extrametrical or not. These markings are governed by rules sensitive to the identity of the final consonants, the identity of any final suffixes, and the part of speech to which the word belongs. These rules for the most part express only tendencies, as most of them have exceptions which are not perceived to be phonologically deviant. The English Stress Rule and Long Vowel Stressing, by contrast, are virtually exceptionless, thus accounting for the deviance of imaginary words like Liberman and Prince's póni[Dów]d (where the Long Vowel Stressing hasn't applied) and póděctál (where stress has been retracted further back than the English Stress Rule will allow). We can also see why the Russian words Nínotchka and bábushka were adapted into English with penultimate stress.

The theory has accounted for this pattern of facts while remaining within the set of formal devices allowed under the general framework--we have used a monosyllabic foot construction rule, a rule assigning quantity-based binary feet, and rules assigning extrametricality to single consonants and rimes. What I haven't shown is why the proposal is to be preferred over other accounts. For example, under a looser framework we could unify all non-lexical stress placement

in nouns by specifying a single rule of foot construction such as (19), repeated from Chapter 1:

(19) At the right edge of a word, construct the largest possible foot, subject to the following conditions:

- i. The foot is right branching, with sister nodes labeled *s w*.
- ii. The foot may not contain more than three syllables.
- iii. The rightmost weak syllable of the foot must not contain a long vowel.
- iv. The remaining weak syllable, if there is one, must be light.

In addition, my analysis hasn't accounted for a large number of ternary feet that occur other than in word final position. These generally are found in systematically definable environments. One type, for example, shows up in Greek prefixes ending in -o, such as in héterodòx, hélìcogràph. Ternary feet are also found in weak stressed position in long monomorphemic words, such as Wìnnepesáukee, Kìlimanjáro. Finally, ternary feet are often formed crossing over the phonetic sequence /i^ˇ/, as in detérioràte, méteoròid. In the remainder of this chapter I will show that none of these ternary feet need be constructed by a ternary foot construction rule per se--that in every case the evidence points to an analysis in

which only binary feet are assigned at an earlier stage of the derivation, with the surface ternary foot derived by Stray Syllable Adjunction. Sections 3 and 4 will support and defend the analysis just presented concerning the construction of word final feet. The sections that follow deal with the other environments in which ternary feet are found, and will motivate solutions in which it is binary feet that are assigned by rule. The overall result will support the restrictions on the form of foot construction rules that I have proposed.

3. Stress Retraction

In this section we will fill in some further details of our system, discussing how the feet are constructed which lie to the left of the one constructed by the English Stress Rule. In the course of doing so, we will discover an argument that supports the proposal of the previous section, by which word final feet in English are constructed with the aid of extrametricality rules.

It will be helpful to have a straw man available, both for purposes of attacking and in order to have a basis for describing some of the phenomena involved. I will adopt here as my straw man a modified version of the proposal for English stress assignment made in Liberman and Prince (1977), adapted into a more purely metrical framework. These authors, it will be recalled, use the feature [+stress] instead of distinguishing between foot and word trees. However, translation of what they claim into a foot based framework

should be fairly straightforward. Liberman and Prince propose the following as the basic stress rule of English:

$$(1) \quad V \rightarrow [+stress] / \text{---} C_0 (\check{V} C_0^1) (\check{V} C_0) \left\{ \begin{array}{l} \# \\ [+stress] \end{array} \right\}$$

In metrical terms, (1) is essentially the equivalent of (19) in the previous section. The rule applies iteratively from right to left, assigning all the stresses of the word. Liberman and Prince note, however, that stress often is not placed as far to the left as (1) implies. Such non-maximal stress assignment is typically triggered by particular suffixes. For example, the suffix -ate fairly generally places stress two syllables to its left, without regard to the quantity of the immediately preceding syllable:

$$(2) \quad \begin{array}{ll} \acute{d}\acute{e}sign\grave{a}te & \acute{c}\acute{o}rusc\grave{a}te \\ \acute{e}x\acute{a}cerb\grave{a}te & \acute{c}\acute{o}ncentr\grave{a}te \\ \acute{c}\acute{o}nfisc\grave{a}te & \acute{a}rtic\acute{u}l\grave{a}te \end{array}$$

To account for this, it might seem that we need a special stress rule for -ate, which we will give the name Strong Retraction:

(3) Strong Retraction

$$V \rightarrow [+stress] / \text{---} C_0 V C_0 [+stress]$$

Similarly, many suffixes having a long vowel, such as -ine, -oid, -ile, etc., usually place stress on the immediately preceding syllable if it is heavy, otherwise two syllables

to the left:

(4) molybdenite	stalágmite
sélenite	archimándrite
sólenoid	mollúscoid
cýanide	peróxide

This suggests a further stress rule, which we will call Weak Retraction:

(5) Weak Retraction

$$V \rightarrow [+stress] / _ C_0 (\check{V}C_0^1) [+stress]$$

Lieberman and Prince noted, however, that both Strong and Weak Retraction are in fact expressible as substrings of the full English Stress Rule:

$$(6) V \rightarrow [+stress] / _ C_0 (\check{V}C_0^1) (\check{V}C_0) \left\{ \begin{array}{c} \# \\ [+stress] \end{array} \right\}$$

$$V \rightarrow [+stress] / _ C_0 (VC_0) [+stress] \text{ (Strong)}$$

$$V \rightarrow [+stress] / _ C_0 (\check{V}C_0^1) [+stress] \text{ (Weak)}$$

This suggested a reformulation which didn't require such a proliferation of rules: the parenthesized expressions of the full English Stress Rule were indexed:

$$(7) V \rightarrow [+stress] / _ (\check{V}C_0^1)_a (\check{V}C_0)_b \left\{ \begin{array}{c} \# \\ [+stress] \end{array} \right\}$$

so that Strong Retraction and Weak Retraction could be formulated simply as the suppression of a or b in certain morphological circumstances: Strong Retraction would result from the suppression of the term a whenever the suffix -ate was analyzed as the [+stress] term of the rule, while Weak Retraction would be the suppression of the term b whenever [+stress] analyzed one of the suffixes -ite, -ide, -oid, etc.

It should be noted what happens when Liberman and Prince's rule is translated into a framework lacking the feature [+stress]: the rule would specify that the maximal template for feet in English is as follows:

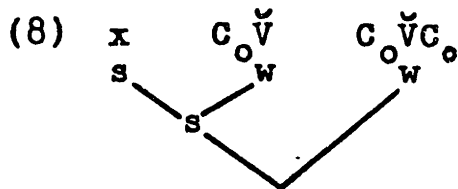

The equivalent notation for the suppression of the terms a and b would be to allow either of the two recessive nodes to be suppressed under the appropriate morphological circumstances. Notice, however, that a foot template of the form (8) would be regarded as highly marked under our theory: it not only is ternary, but also refers simultaneously to two different criteria of syllable quantity, branching vs. non-branching rimes and long versus short vowels. Unless a different analysis of the English stress pattern is available, Liberman and Prince's proposal is a serious counterexample to our theory.

In this thesis we will take a rather different approach to stress retraction in English: we will assume that Liberman and Prince's observation that Strong Retraction is a subpart of the full English Stress Rule does not represent a linguistically significant generalization, and will show that useful descriptive results can be obtained if we assume that Strong Retraction and the English Stress Rule are in fact separate rules. We will further propose that Weak Retraction is not a subpart of the English Stress Rule, but that the two rules are in fact one and the same.

We will begin by providing a formulation for our separate rule of Strong Retraction:

(9) Strong Retraction

Form quantity insensitive, left dominant feet,
going from right to left across the word.

The iterative formulation of the rule will later be seen to be useful in deriving words like Àpalàchicóla, hàmameliánthemum. Now if the English Stress Rule and Strong Retraction are separate rules, we can usefully inquire as to how they are ordered with respect to one another. Recall from the previous section that there are strict constraints on how far to the left the rightmost stress in an English word may fall: cf. *póni[Dowd], *pódectal. If Strong Retraction is ordered before the English Stress Rule, it would be impossible to account for these constraints, as the derivation of (10) shows:

(10) podec(tal)

Noun Extrametricality

podec(tal)



Strong Retraction

pódec(tal)

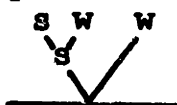

Stray Syllable Adjunction

English Stress Rule

We conclude that Strong Retraction must apply after the English Stress Rule.

There is one more ingredient that must be presented to motivate the argument that follows: it can be shown through numerous examples (some to be presented below) that the English Stress Rule applies cyclically. When it does, the rule differs from most foot construction rules in that it fails to respect the boundaries of feet created earlier: any structure that existed on a earlier cycle is deleted if the new foot constructed by the English Stress Rule encroaches on it. Some examples of this phenomenon are as follows:

(11) [parent]al



[homonym]ous

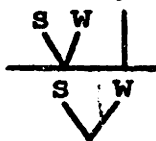

earlier cycles

paren(tal)

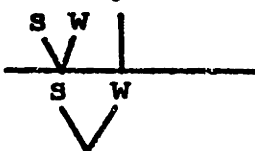

homony(mous)

last cycle
Adjective
Extrametricality

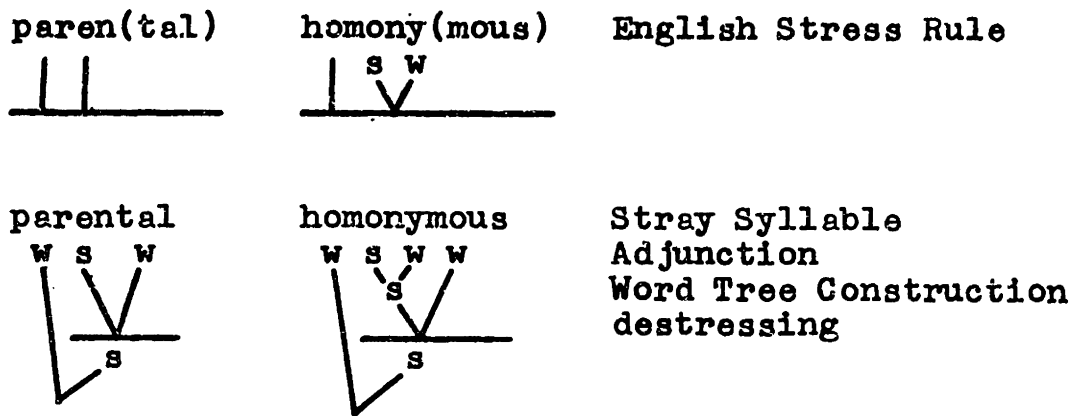

Lieberman and Prince have a different proposal to account for this property of the English Stress Rule: they suggest that at the end of each cycle all metrical structure is deleted, with the information about the location of stresses retained using the feature [+stress]. Such a theory obviously requires us to give up the advantages we gained in abolishing the feature [+stress], and has in fact been shown by Kiparsky (1979) to be wrong on independent grounds.

Now that we have established a fairly explicit analysis, we can present a rather striking argument for it: unlike under Lieberman and Prince's system, it is by and large unnecessary under the new system to mark individual suffixes for the mode of retraction they trigger. Their retraction behavior follows automatically from the rules of extrametricality, which are needed independently. Consider first the verbal suffix -ate, which is a Strong Retractor. Our analysis will derive verbs that end in -ate in the following way. The first rule to apply will be Long Vowel Stressing, which will create a non-branching foot over -ate:

(12) designate coruscate
 _____| _____|

The extrametricality rules come next in the ordering. The only one of them to apply will be Consonant Extrametricality, since the forms of (12) are neither nouns nor suffixed adjectives:

(13) designa(te) corusca(te)
 _____| _____|

We then apply the English Stress Rule, which, it will be recalled, ignores the boundaries of feet created earlier in the derivation. The English Stress Rule will accordingly apply vacuously in this case, restressing the final syllable:

(14) designa(te) corusc a(te) English Stress Rule
 _____| _____|

The next rule in the ordering is Strong Retraction, which constructs a binary, quantity insensitive foot over the first two syllables of both words:

(15) designate coruscate
 s w | s w |
 √ | √ |
 _____| _____|

The final result follows from Word Tree Construction:

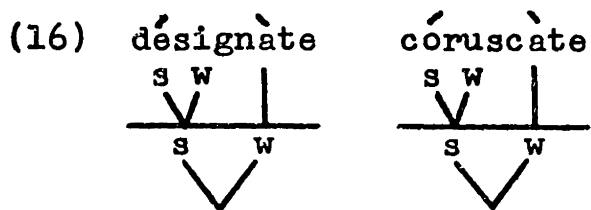

It should be clear that under a theory that applies the English Stress Rule and Strong Retraction as separate rules in the order given, the status of -ate as a Strong Retractor follows automatically from its being a verbal suffix, hence not extrametrical.

Let us now examine two typical weak retracting suffixes: -ite and -ine. We will derive two examples, the noun stalac-tite and the adjective elephan-tine. In both words, the final syllable will be stressed early in the derivation by Long Vowel Stressing:⁴



The extrametricality rules will then apply: Noun Extrametricality to stalactite, and Adjective Extrametricality to elephantine, since -ine is an adjectival suffix:

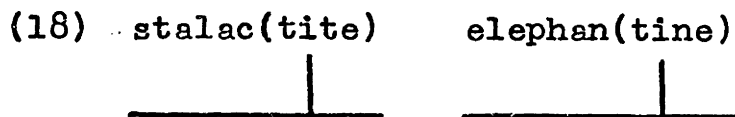

We then apply the English Stress Rule and Strong Retraction:

Adjective Extrametricality is: the suffixes that regularly undergo it include the five stressless suffixes -al, -ent, -ant, -ive, and -ous, plus the following long voweled suffixes: -oid, -ile, -ine, -ose, -ane, -ary, -ory (the latter two will be discussed shortly), and -ate. The latter suffix, which occurs in words like apóstàte, ecóstàte, intéstàte, arístàte, points out another advantage of the present analysis: under our account, it is an automatic consequence that -ate should be a Weak Retractor when it occurs in adjectives, since the rule of Adjective Extrametricality is allowed to apply. By contrast, under Liberman and Prince's account, the retraction properties of each suffix are listed idiosyncratically, so that an ad hoc statement would be required to make -ate a Weak Retractor in adjectives but a Strong Retractor in verbs.

A further argument can be derived from the history of English stress retraction around the first half of the nineteenth century. As Halle and Keyser (1971) point out, prior to this time, verbal -ate was a fairly regular Weak Retractor, while the long voweled nominal and adjectival suffixes often triggered Strong Retraction. The shift in retraction behavior can in both cases be regarded as a step towards regularizing the system: the verbs ending in -ate took on the regular property of verbs in not having their final rimes marked for extrametricality, while the nouns and adjectives, which had to be marked as irregular in not having extrametrical final rimes, simply lost their exceptional markings. The

new explanation for the shift that our theory provides is especially desirable, since it can be shown (Hayes 1978) that Halle and Keyser's explanation is inadequate.

Our theory clearly needs some further work to be firmly established: in particular, we must show that Noun and Adjective Extrametricality are fairly regular processes, and that Strong Retraction is in general adequate to derive all of the feet found to the left of the foot assigned by the English Stress Rule. None of these claims appears to be true on immediate inspection (cf. Häckensäck, mércantile, Winnepesáukee), but a closer look at the facts will show that each claim can in fact be supported.

4. The Phonological Cycle

One of the most elegant contributions of Chomsky and Halle (1968) was the demonstration that the English stress rules must apply cyclically, assigning stress to the internal bracketed domains of derived words before assigning stress to the word as a whole. Chomsky and Halle's proposal accounted for subtle but fairly regular distinctions such as that between ^{3 4 1}indentation, ^{3 4 1}detestation and ^{3 0 1}compensation, ^{3 0 1}confiscation; the former pair displays weak stress on their second syllables because on an earlier cycle, these syllables had received main stress: indént, detést. By contrast, compensation and confiscation have stressless second syllables because in the words of their inner cycles, compensáte and confiscáte, these syllables are stressless. In this section, we will discuss how our rules must be stated in

order to obtain the same good results. Along the way, we will discover another argument that favors our analysis over Liberman and Prince's theory.

For the sake of argument, let us return for the moment to the Liberman and Prince theory, and ask the following question: if suffixes are lexically marked for the kind of retraction they trigger, what kind of retraction is triggered by the suffix -ation? The following examples:

- | | | |
|-----|-------------|--------------|
| (1) | fòrestátion | còruscátion |
| | ìndignátion | cònfiscátion |
| | | òbfuscátion |

suggest that it cannot be Weak Retraction: if this were so, we would get fòrestátion^{3 4 1} in parallel with infestation. The reader might object that in the three examples of the second column, it might be -ate, rather than the full suffix -ation, that is triggering Strong Retraction. However, there is evidence available elsewhere that compound suffixes like -ation are treated by the stress rules as single units: the suffix -ative (to be dealt with below) triggers Weak Retraction no matter whether it is affixed as a morphological unit, or as the concatenation of -ate and -ive:

- | | | |
|-------|-------------|---------------|
| (2)a. | íllustrate | illústrative |
| | démonstrate | démónstrative |
| b. | consérve | consérvative |
| | árgument | arguméntative |

Thus it is reasonable to infer that it is -ation as a whole that must be marked to trigger the retraction in (1).

If -ation cannot be a Strong Retractor, we must examine the remaining possibilities. The following examples:

- | | | |
|-----|----------------|-----------------|
| (3) | diplomatizáció | retrogradáció |
| | democratizáció | multiplícación |
| | legitimizáció | syllabificación |

suggest that -ation might best be regarded as retracting stress across the full domain allowable under the English Stress Rule; in Liberman and Prince's terms it would be called a Long Retractor. Notice that these examples show that -ation definitely could not be a Strong Retractor, since if this were so we would get *démocràtizáció, *diplo-màtizáció, *retrogradáció, etc. But even Long Retraction fails in examples like (4):

- | | |
|-----|----------------|
| (4) | stàndardizáció |
| | sòlemnizáció |
| | fràternizáció |

in which we would expect *stàndàrdizáció, *sòlemnizáció, and *fratèrnizáció. Clearly, there is no one retraction mode which will account for the behavior of all the words in -ation. Do we need, then, to mark every word ending in -ation for the type of secondary stress assignment it undergoes? Obviously not: the secondary stresses in all of the words presented fall on the same syllables that are stressed

in the word from which the noun in -ation is derived. In order to derive the correct results, all we have to do is prevent any more foot construction from being carried out after -ation has been stressed.

Before going on, I should mention that not all the stresses of a base word necessarily show up in the derived word in -ation. The positions in which the earlier stresses disappear are well known, and can be accounted for using the following rule:

(5) Pre-Stress Destressing

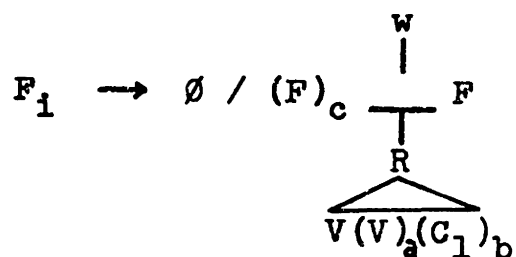

Conditions: a \rightarrow c

b \rightarrow F_1 must be a prefix.

In prose, this says delete a non-branching, non-final foot in weak metrical position. If the foot dominates a long vowel, it must be non-initial (cf. pròvòcátion vs. tòtáality). If it dominates a closed syllable, it must be a prefix (cf. còntáin vs. pòntóon). This rule does not remove feet in post-stress position, as in curscry. As we will show in Section 8, this form of destressing must be carried out by a separate rule. An example of the application of Pre-Stress Destressing is as follows:

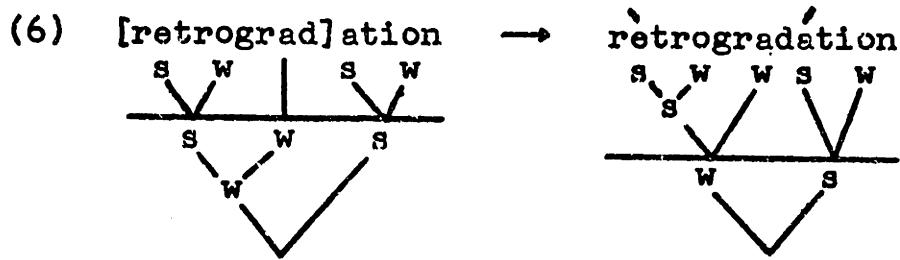

Pre-Stress Destressing is often fed by the Rhythm Rule, as in (7):

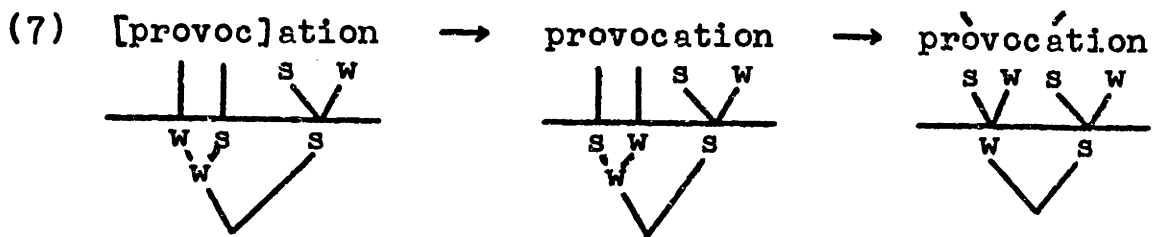

Compare relaxation, in which Destressing cannot apply because the relevant syllable is closed:

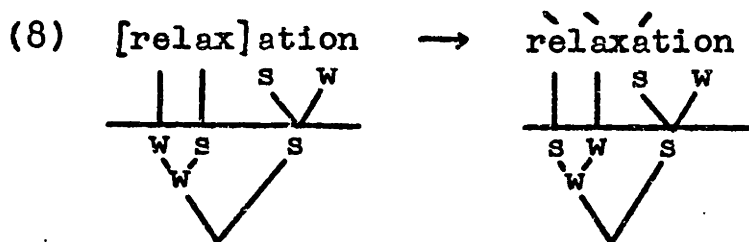

Let us now consider how the theory we are proposing will stress words ending in -ation. The problem is complicated slightly by the existence of a few words ending in -ation, such as indignátion, compurgátion, ostentátion, in which there is no embedded word: obviously, -ation must be able to trigger stress retraction some of the time, in order to stress these examples. We will show here that the present

analysis, without modification, can account for all of these facts. Recall the normal mode of interaction among rules that construct feet (see Chapter 3, p. 79): generally, such rules will respect the boundaries of feet constructed earlier. This principle is supported by numerous analyses throughout this dissertation. The English Stress Rule is an exception to it, as it can delete previously existing structure, as in párent-paréntal. However, we have no reason to suppose that Strong Retraction is an exception, and in fact we get good results if we assume that it behaves in the normal way, respecting previously assigned foot boundaries. Let us consider the derivation of fraternization. In the first cycle, the suffix -ize is not marked as extrametrical, which is the norm for verbs. When the time comes for the English Stress Rule to apply, it constructs a monosyllabic foot over ize:

(9) [fraterniz]ation



Strong Retraction then applies, constructing a foot over frater:

(10) [fraterniz]ation



The first cycle is completed by Word Tree Construction:

(11) [fraterniz]ation

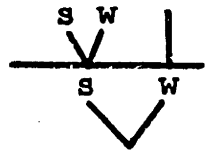

On the next cycle, -ation is stressed in the normal way by Noun Extrametricality and the English Stress Rule. Strong Retraction is then blocked by the presence of metrical structure assigned earlier:

(12) fraterniza(tion)

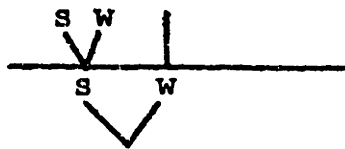
Noun Extrametricality⁵

fraternization

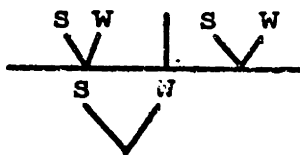
English Stress Rule
Stray Syllable Adjunction

Strong Retraction

The remainder of the derivation is carried out by Word Tree Construction and Pre-Stress Destressing:

(13) fraternization

Word Tree Construction

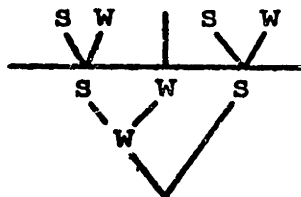

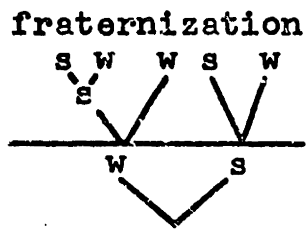

Pre-Stress Destressing
Stray Syllable Adjunction

Notice that the latter rule is optional in words ending in -ization, which accounts for the alternate pronunciation fràtern[ày]zàtion.

The derivation of fraternization should be compared with that of compurgation, in which there is no internal cycle. The first rules to apply will be Noun Extrametricality and the English Stress Rule:

(14) compurga(tion)



After Stray Syllable Adjunction has adjoined the final syllable, Strong Retraction will be free to apply, since no structure already exists over the first two syllables:

(15) compurgation

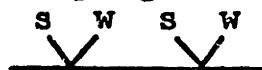

The final result derives from Word Tree Construction:

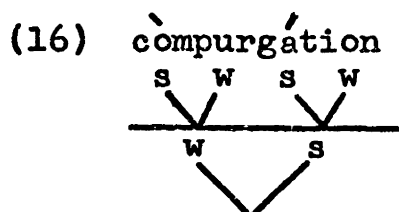

It can be seen that under the analysis proposed here, the quirky retraction behavior of -ation is no accident: the fact that -ation assigns stress to its left only when no previously assigned stress occurs there follows from a principle of universal grammar, which says that in the unmarked case, rules of foot construction respect the boundaries of previously constructed feet.

In order to strengthen this argument, we must show that there is no simple way to modify Liberman and Prince's analysis that would get the same results. The only theory I can think of would be to postulate the principle that foot construction rules in English may apply only if there is at least one syllable in their domain that hasn't been assigned to a foot. Under this theory, the English Stress Rule would be free to construct a foot at the following point in the derivation of compurgation:

(17) compurgation

since there still are free syllables available to be assigned to a foot. But at the corresponding point in the derivation of fraternization: i.e. (18)b:

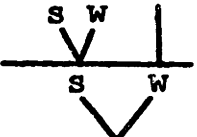
(18)a. [fraterniz]ation first cycle

b. fraternization

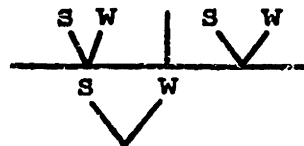

second cycle

the rule would be blocked, since all the available syllables are already incorporated into the metrical structure. Notice that under this theory, the English Stress Rule would still be allowed to derive sentimental from sentiment, since there is one syllable on the second cycle that hasn't been incorporated into the tree:

(19) [sentiment]al



first cycle

sentimental

second cycle
English Stress Rule

sentimental

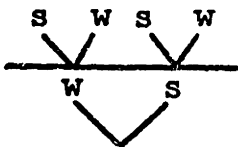



Word Tree Construction

Thus on the data given so far the theory seems to work fairly well. But we encounter serious problems in trying to account for another class of suffixes--those which under Liberman and Prince's framework are marked to trigger Weak Retraction. Consider the following alternations:





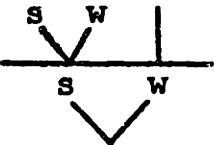



(20)	móllusk	mollúscòid	cícatrìx	cicátricòse
	pýramid	pyrámidòid	fílament	filaméntòse
	gélatin	gelátinòid	élephant	elephántine
	díatom	diátomìte	lábyrinth	labyrínthine
			hýacìnth	hyacínthine
			ámethyst	amethýstine

Under the proposal we have just made, the stress rule would be expected to apply just once in the final cycle of the derived forms, stressing the final long vowel:

(21)	[mollusc]oid	first cycle
		
	molluscoid	second cycle
		English Stress Rule
	*molluscoid	Word Tree Construction
		

Since the remaining portion of the word is already provided with metrical structure, the stress rule could not apply further, so that the phonetic output would be *mólluscòid; similarly *fílamentòse, *díatomìte, etc.

The theory advocated here runs into no such problems. Words like molluscoid and diatomite are stressed in the ordinary way:

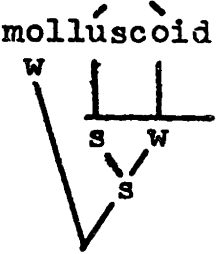
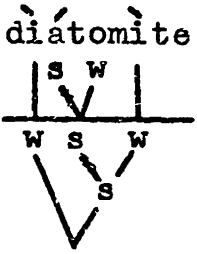
(22)	[mollusc]oid	[diatom]ite	first cycle
			
	molluscoid	diatomite	second cycle Long Vowel Stressing
			
	mollus(coid)	diato(mite)	Adjective Extrametricality Noun Extrametri- cality
			
	mollus(coid)	diato(mite)	English Stress Rule
			
	mollúscoid	diátomite	Word Tree Con- struction Pre-Stress Destressing
			

Under the theory, there is no requirement that free syllables be present in order for the stress rules to apply. Since the English Stress Rule is privileged to delete previously existing metrical structure, it is free to shift the stress in forms like (22).

Notice that the analysis proposed here makes a definite prediction about the stress behavior of -ate: recall that in general, the final rimes of verbs in English are not extrametrical. -Ate accordingly receives the foot constructed by

the English Stress Rule, so that all material to its left must be stressed by Strong Retraction. Since Strong Retraction cannot delete older structure, we would predict that it should be impossible for -ate to destroy structure created on earlier cycles. This prediction appears in general to be true, as the following alternations attest:

(23)	óxygen	óxygenàte	sequéster	sequéstràte
	hýdrogen	hýdrogenàte	mýelin	mýelinàte
	péregrin	péregrinàte	óriènt	¹ ³ ² orientàte

Alternations such as salíva-sálivàte, vagína-eváginàte do not constitute counterevidence, as the stems saliva and vagina are subject to an allomorphy rule shortening their vowels before suffixes, as in sálivàry, váginàl. The true exceptions would include oríginàte and (for some speakers) hydrógenàte. These verbs would have to be marked exceptionally for extrametricality, just like other exceptional -ate verbs, such as imprégnàte, adúbràte.

It is worth pointing out that Kiparsky (1979) has come to essentially the same conclusion concerning the organization of the cyclic stress rules as I have, although on quite different grounds. Kiparsky's argument is based on the contrast of words like those of (24)a with those of (24)b:

(24)a.	³ ² ¹ iconoclastic	b.	³ ² ¹ ² ³ ¹ Ticonderoga Ticonderoga
	³ ² ¹ anticipation		³ ² ¹ ² ³ ¹ Ompompansoosuc Ompompanoosuc
	³ ² ¹ totalitarian		³ ² ¹ ² ³ ¹ Dòdecànèsiàn Dòdecànèsiàn

For many speakers, the words of (24)a must be pronounced with weaker stress on the initial syllable than on the second, whereas in the words of (24)b, either secondary stress may be the stronger. The difference presumably results from the derivational history of the words of (24)a: the base words from which they are formed all have second syllables with stronger stress than their initial syllables: ìcónoclast, àntícipate, tòtálicity. To account for the difference, Kiparsky makes two assumptions: first, that word trees in English are freely constructed as right or left branching; and second, that the cyclic application of the stress rules is governed by the following principle:

- (25) Metrical structure assigned in earlier cycles is kept, insofar as it is not redrawn by (the foot construction rules). (p. 422).

The first assumption allows for two metrical structures to be constructed over Ticonderoga, one left and one right branching:

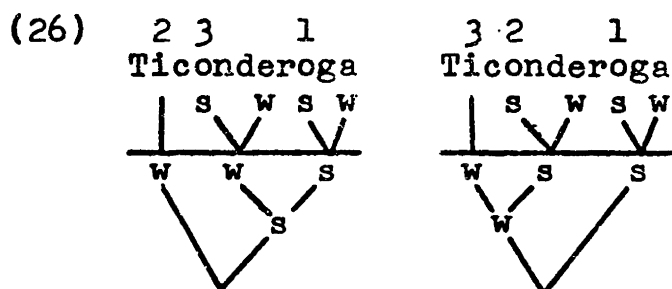

which will account for the phonetic stressings, given the principle that, at least in English, less deeply embedded

weak feet receive greater prominence. In iconoclastic, however, cyclic application of the stress rules will force the construction of a left branching tree:

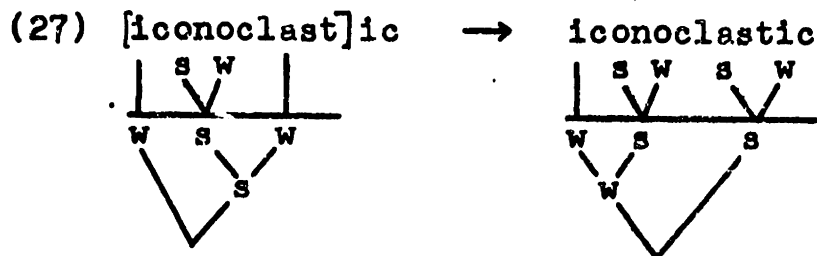

so that only the 3-2-1 stressing is possible. Notice that the Rhythm Rule cannot apply to (27), since as we saw in Chapter 4, it is blocked in cases where the dominant node branches and the recessive node does not.

Kiparsky's crucial assumption, stated under (25), is of course strongly reminiscent of our proposal, in which only the English Stress Rule creates new structure in a given cycle, with the remaining structures preserved intact. Our analysis thus has the advantage of formulating in an explicit and well motivated way the principle of rule application that Kiparsky must assume to make his analysis work.

5. Two Destressing Rules

In this section I will discuss two rules of destressing that have been motivated in the literature. These rules will be shown to eliminate many of the exceptions to the stress assignment rules proposed thus far.

The first destressing rule is presented in Kiparsky, (1979). Kiparsky observes that the suffixes -ory and -ary are normally weak retractors:

(1)	olfáctory	eleméntary	dórmitory
	trajéctory	annivérsary	inhíbitory
	advísory	valedíctory	plánetary

We will discuss how these suffixes should be accounted for later--it should be assumed for the moment that this Weak Retraction is in fact a normal application of the English Stress Rule. The relevant point here, pointed out by Kiparsky, is that there is a fairly systematic class of exceptions to Weak Retraction with these suffixes: when they occur preceded by two syllables, of which the second ends in a sonorant, we get initial stress:

(2)	légendarý	désultory
	mómentary	répertory
	frágmentary	íntentory

Kiparsky proposes that in these words, Weak Retraction (in our terms, the English Stress Rule) applies normally, but that the foot it constructs is sometimes deleted by a destressing rule, which we will phrase as follows:

(3) Sonorant Destressing

$$F_i \rightarrow \emptyset / \begin{array}{c} F \quad F \\ | \quad \text{---} \\ R \\ \triangle \\ V [+son] \end{array} \quad \text{Condition: } F_i \text{ is not dominated by } s.$$

The condition that F_i not be dominated by s insures that strong feet assigned on earlier cycles will not be removed:

cf. infirmary, responsory, dispensary. This means that Sonorant Destressing has to apply in the cycle after foot construction, but before word tree construction, since the word tree would mark the second syllables of legendary, desultory etc. as strong, just like the second syllables of olfactory, elementary. Some illustrative derivations are the following:

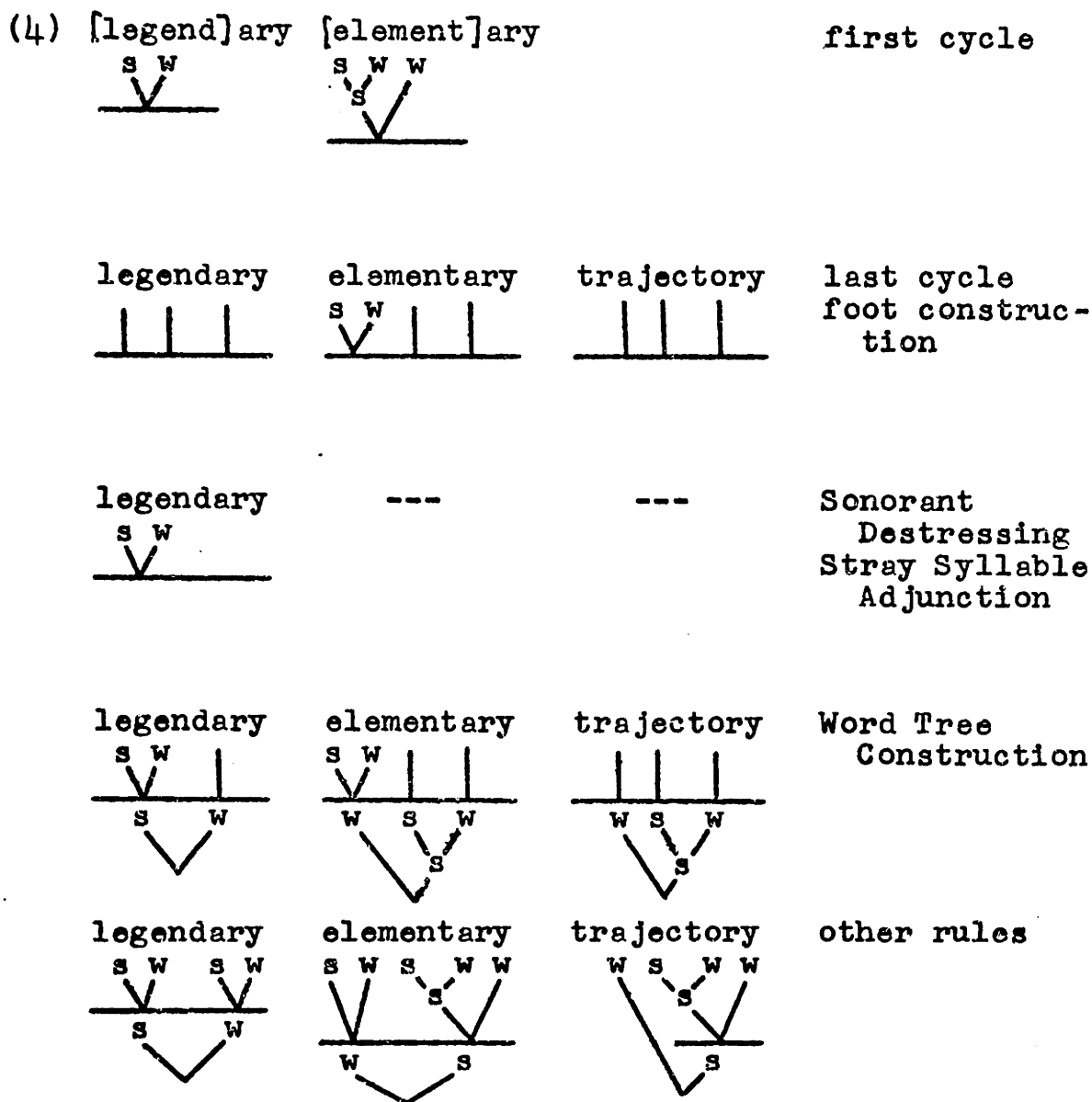

Sonorant Destressing appears to be a fairly general rule of English. For example, it applies before the other

weak retracting suffixes in the same way that it applies before -ary and -ory:





(5)a.	salamándroid	mollúscoïd	hélminthoïd
	epicycloïd	aráchnoïd	cýlindroïd
b.	quadripártite	staláctite	gílbertyte
	archimándrite	gelígnite	árgentyte
c.	elephántine	smarágdine	sérpentyne
	adamántine	uléxine	sáturnine

There are only a few exceptions, such as odóntoïd and Tri-déntyne. I will show here that the stress rules make better predictions if we assume that Sonorant Destressing applies widely among the monomorphemic words of English as well. This claim will have the additional benefit of removing a very large number of putative exceptions to our rules. The words in question are those of the form (6):



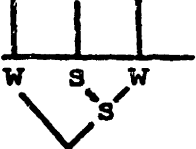
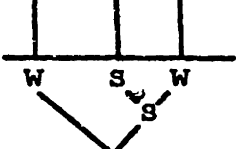

(6)a.	Hóttentòt	Jáckendòff
	bálderdash	ámpersànd
	Háckensàck	Árkansàs
	Álgeròn	máckintosh
b.	dávenpòrt	mérchandise
	cávalcade	pálindròme
	níghtingàle	Áppelbàum
	Áberdeen	mísanthrópe

These words all have final secondary stress, determined either by a foot present in underlying representation, as in (6)a,

or by Long Vowel Stressing, as in (6)b. Without Sonorant Destressing, we would predict penultimate main stress for these words, as in (7):

(7)	ampersand	merchandise	underlying representation
			
	---	merchandise	Long Vowel Stressing
			
	amper(sand)	merchan(dise)	Noun Extrametricality English Stress Rule
			
	*ampérsand	*merchéndise	Strong Retraction Word Tree Construction
			

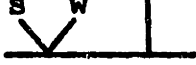
But if we assume that Sonorant Destressing may apply here, the correct results obtain:

(8)	ampersand	merchandise	Long Vowel Stressing Noun Extrametricality English Stress Rule Strong Retraction
			
	ampersand	merchandise	Sonorant Destressing Stray Syllable Adjunction
			

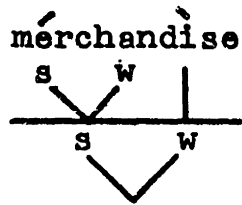
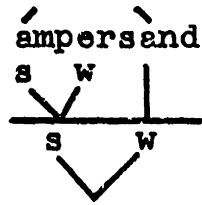

Word Tree Construction

In fact there is good evidence that Sonorant Destressing is applying in the words of (6), since in the great majority of the cases in which Sonorant Destressing cannot apply, we get penultimate main stress:

- | | | | | |
|-------|-------------|--------------|----|-----------|
| (9)a. | Àdiròndàck | Massapéquòd | b. | Monádnòck |
| | Èniwétòk | Mèmphremàgòg | | Hopátcòng |
| | Àgamémnòn | Àniákchàk | | Aquídnèck |
| | Kàlimántàn | | | Penòbscòt |
| | Girilámbòne | | | Orestès |

These will be derived by our normal rules as follows:

- | | | | |
|------|--------------|-------------|--|
| (10) | Adirondack | Monadnock | underlying representation |
| | | | |
| | Adiron(dack) | Monad(nock) | Noun Extrametricality
English Stress Rule |
| | | | |
| | Adirondack | Monadnock | Strong Retraction |
| | | | |
| | --- | --- | Sonorant Destressing |

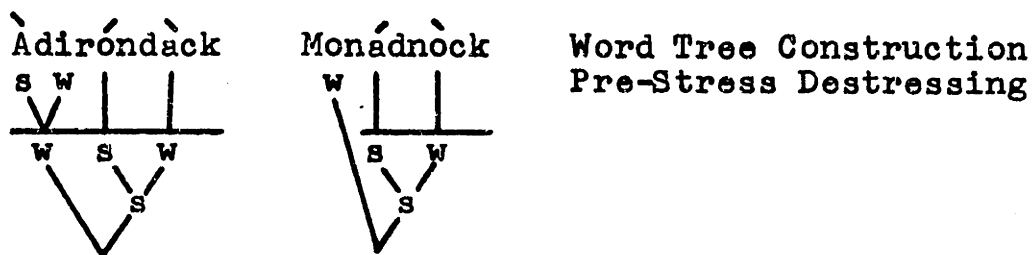

Because of Sonorant Destressing, we can say that Noun Extrametricality is virtually exceptionless. The only nouns I know of that must be marked as exceptions are pálimpsèst, Árbuthnòt, and ánecdòte. In these words, the final syllable must not be extrametrical, so that it will be stressed by the English Stress Rule, thus enabling Strong Retraction to form a foot over the first two syllables.

Another destressing rule of English, discussed and motivated in Ross (1972), deletes a non-branching foot in weak position if (a) it is preceded by a foot that dominates a single non-branching rime; (b) the syllable it dominates has a short vowel. The rule can be stated formally as follows:

$$(16) \quad F \rightarrow \emptyset / \begin{array}{c} \text{w} \\ | \\ \text{F} \\ | \\ \text{R} \\ | \\ \text{VC}_o \end{array}$$

The rule is traditionally called the "Arab Rule", since it accounts for the two dialectal pronunciations of the word arab: [ærəb] and [eýræb]. We can assume that in both pronunciations, one of the redundancy rules motivated in

Ross (1972) specifies a monosyllabic foot in final position. The two pronunciations differ only in the length of the initial vowel, the difference in the stress on the final syllable being an automatic consequence of the Arab Rule:

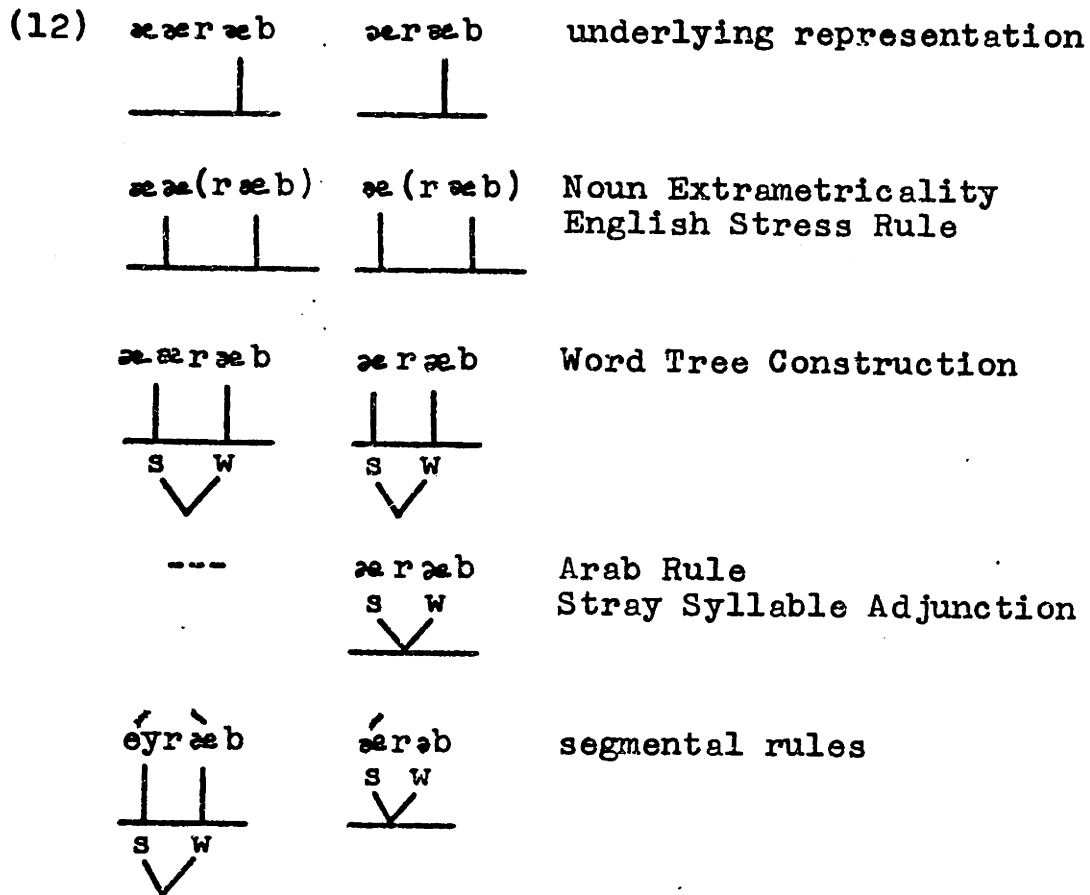

In general, the Arab Rule greatly reduces the number of exceptions to the lexical redundancy rules governing the presence of a monosyllabic word final foot.

The Arab rule can also account for the absence of stress on the second syllable of l`ament`ation, despite the similarity of its derivation to that of in`dent`ation:

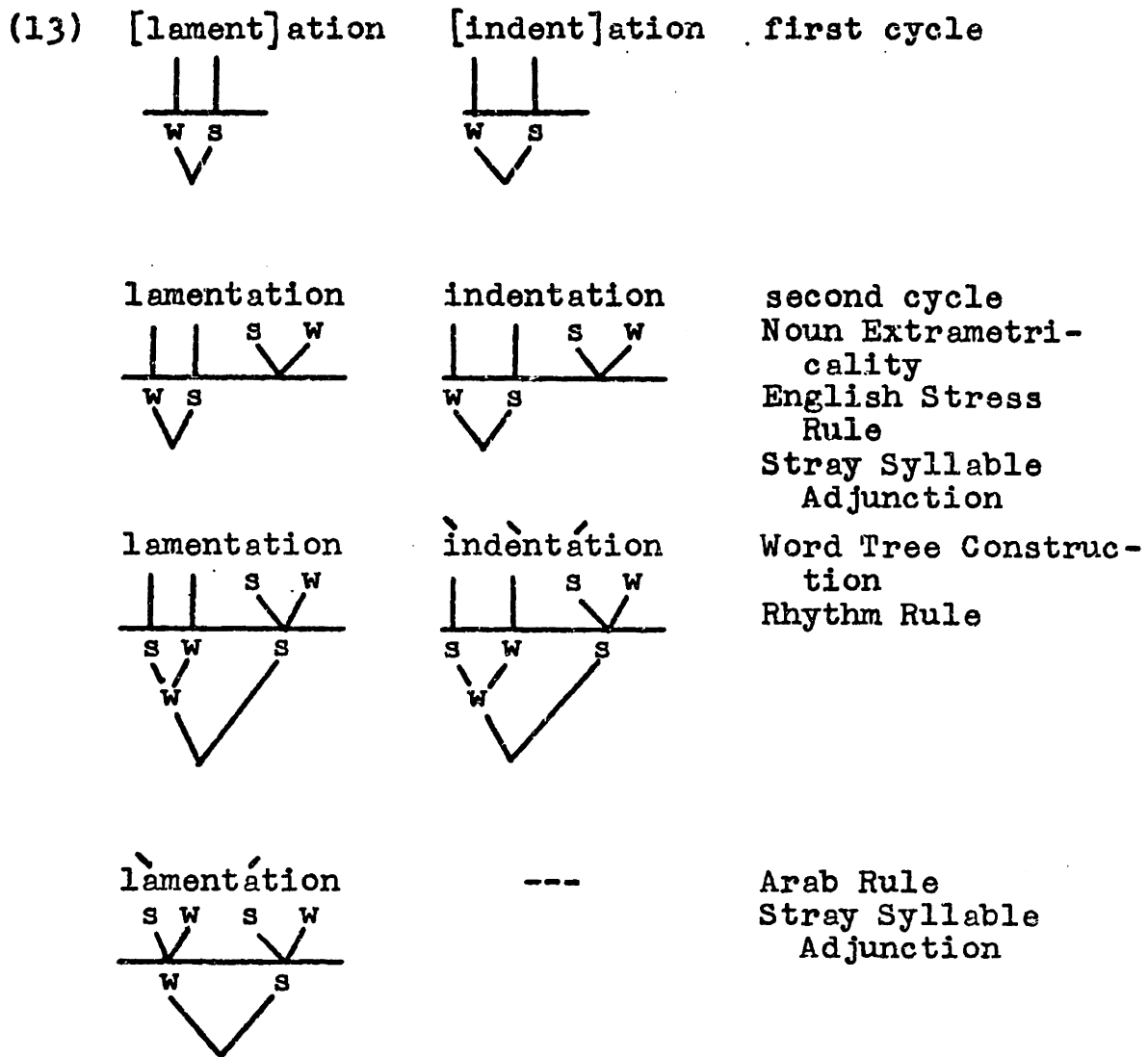

In our analysis, the Arab Rule serves another useful purpose. Recall that under our rules, verbs and monomorphemic adjectives do not have their final rimes marked as extrametrical. This means that if they end in two consonants, they must receive final stress by the English Stress Rule, after Consonant Extrametricality has applied. There are in fact a few exceptions to this prediction:

- (14)a. h^onest m^odest h^aggard j^ocund
 st^ubborn rⁱbald c^overt

b. bóllix góvern flúmmox scávenge
 wárrant

Notice, however, that all of these words are bisyllabic, with a non-branching rime in the initial syllable. This suggests that they are not in fact exceptions to the normal markings for extrametricality, but rather have irregularly labeled word trees: the stress that is placed on their final syllables by the English Stress Rule can then be removed by the Arab Rule, as in (15):

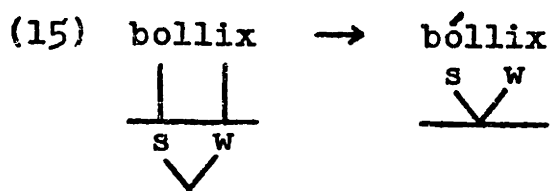

This is essentially the proposal made in Ross (1972), translated into the new framework. The merit of the proposal is that it is no longer a coincidence that the great majority of irregularly stressed verbs and monomorphemic adjectives such as those of (14) have non-branching rimes in their initial syllables. Using the Arab Rule, we can limit the irregular marking of final rimes for extrametricality in such words to a very small number of cases: eárnést and stándard are the only clear examples I know of.



6. Non-Maximal Foot Construction

In some English words main stress falls to the right of what our rules would predict:

(1)	Mississippi	Alabáma
	persímmon	anténna

Such words are quite common, and hardly feel exceptional: as I pointed out before, the function of the English Stress Rule is to specify a maximum, not a minimum foot size. In this section I will discuss some ways we might revise the rules in order to derive words like those of (1).







One proposal that comes to mind is to mark the words of (1) as [-Noun Extrametricality]. Under this theory, the derivation of persimmon would be as follows:

(2)	persimmo(n)	Consonant Extrametricality
	persimmo(n)	English Stress Rule
		
	persímmon	other rules
		

This theory can be shown to be inadequate, since using it we cannot derive words such as those of (3):

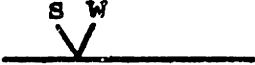
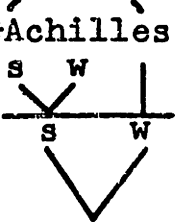
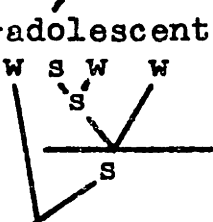
(3)a.	lieuténant	adoléscent	
b.	Ulýssez	Achilles	inspíssate

The stress in these words comes out wrong no matter how we mark them for extrametricality:

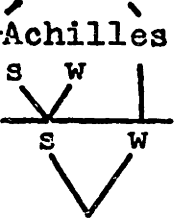
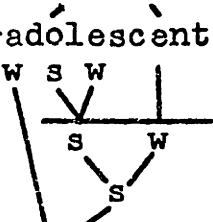
(4)a.	Achilles		Long Vowel Stressing
			
	Achi(lles)	adole(scent)	Noun Extrametricality Adjective Extrametricality English Stress Rule
			
	*Achilles	*adolescent	other rules
			
b.	Achille(s)	adolesc(en)t	Long Vowel Stressing Consonant Extrametricality
			
	---	---	Adjective, Noun Extrametricality
	Achille(s)	adolesc(en)t	English Stress Rule
			
	*Achilles	*adolescent	Strong Retraction other rules
			

The failure of this theory is in fact welcome, since it reinforces the proposal made in the previous section to the effect that Noun Extrametricality is virtually exceptionless. It should be noted in passing that examples like (3)b are exceptions to the theory of Selkirk (1980), in which feet of the form C_0V are held to be restricted to initial position.

Given the failure of the extrametricality theory, we must consider other theories to derive the stress of Mississippi et al. The most reasonable solution appears to be to introduce into English the diacritic [+H], which requires foot construction rules to analyze the rime bearing it as dominant. Representations such as (5):

(5)	Mississippi	Achilles
	[+H]	[+H]

would then be sufficient for obtaining penultimate stress.

7. Further Adjectival Suffixes

A few suffixes have yet to be accounted for. -ory and -ary display Weak Retraction, despite being bisyllabic:

(1)	trajectóry	prómíssory
	advísory	állegory
	sedíméntary	imáginary
	annivérsary	sýllabary

We can account for this by marking them as extrametrical, and assigning them the monosyllabic underlying representations /ɔɔ ry/, /æ æ ry/, along the lines of Liberman and Prince (1977). Their bisyllabic surface forms result from the application of the exceptionless rule (2):

(2) Sonorant Syllabification

[+son] → [+sɪl]/C____#

If (2) is ordered after the labeling of the word tree, we can

account for why -ary and -ory do not receive primary stress, since when labeling occurs they constitute non-branching feet:

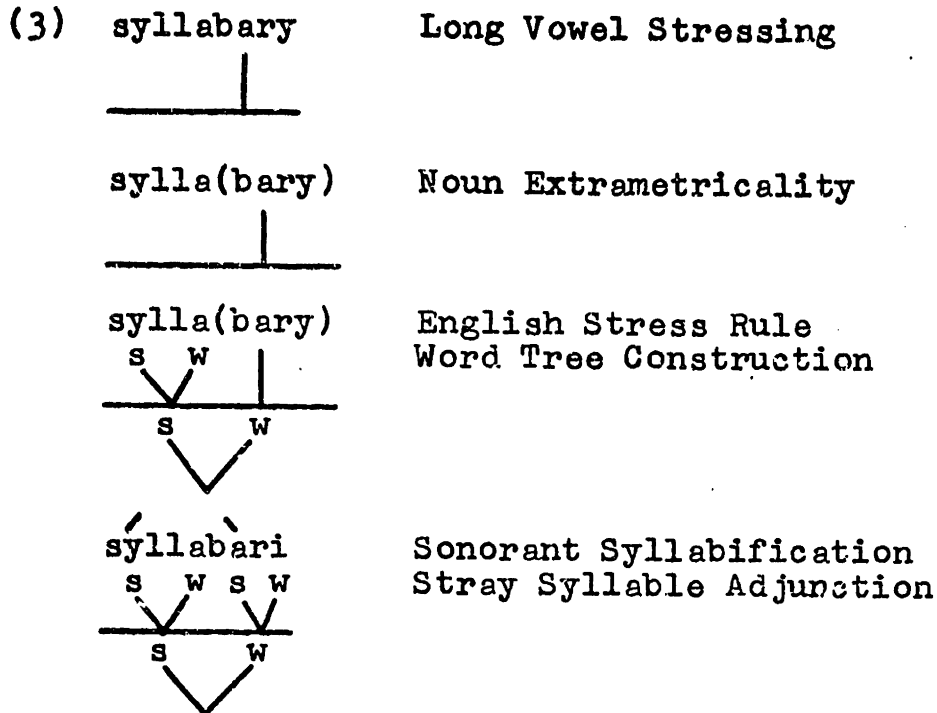

A similar approach yields the stress pattern of words like álligátor, áxolòtl from underlying /æ lig æ æ tr/, /æ ksolotl/. The destressed variants of -ary and -ory, as in trajéctory and annivérsary, result from the rule of Post-Stress Destressing, to be discussed in Section 8.

The wayward children of the English stress system are the suffixes -ative and -atory, both of which are Weak Retractors:

(4)	contéplative	compénsatory
	accúsative	confíscatory
	intérpreatative	manípulatory
	imáginative	úndulatory

Words such as these are the only cases in English where the weak retraction pattern appears more than one syllable from the end of a word. Historically, they derive from the time when -ate was a Weak Retractor, so that the stressing of words like contemplative and compensatory was simply the result of the phonological cycle. To fit them into the synchronic system proposed here we need a special rule of the form (5):

$$(5) \quad \left\{ \begin{array}{l} \text{-ative} \\ \text{-atory} \end{array} \right\} \rightarrow [+ex]/____]$$

Notice that although (5) will make two consecutive rimes [+ex], it still obeys our proposed constraint that extrametricality rules may apply only to constituents, the constituent here being a suffix. The rule (5) might plausibly be viewed as a generalization of the rule of Adjective Extrametricality: rather than marking the final rime of words ending in adjectival suffixes as extrametrical, (5) simply makes the adjectival suffixes themselves extrametrical.

The suffix -ative has the additional peculiarity of bearing secondary stress even though it constitutes a branching final foot. It must therefore be marked diacritically in the same way that words like Ládefòged, rútabàga, and pómegrànete are. The destressed versions of -ative result from Post-Stress Destressing (see section 8), and a minor destressing rule discussed in Nanni (1977).

The greatest peculiarity of -atory is that it isn't pronounced -átory: normally long vowels appearing before -ory bear main stress, as in advisory, illúsyory. As far as I can tell, this is simply an unexplainable quirk under anybody's theory. Under the present framework the best solution would be to say that the underlying form of the suffix is -ǎtory, with a short initial vowel. When -ǎtory is added to verbs ending in -ate, the latter suffix deletes, by the same rule as that deleting -ate before -ee, -ant, and other suffixes, as in nominee, negociant (see Aronoff 1976). We will then have stress derivations such as the following:

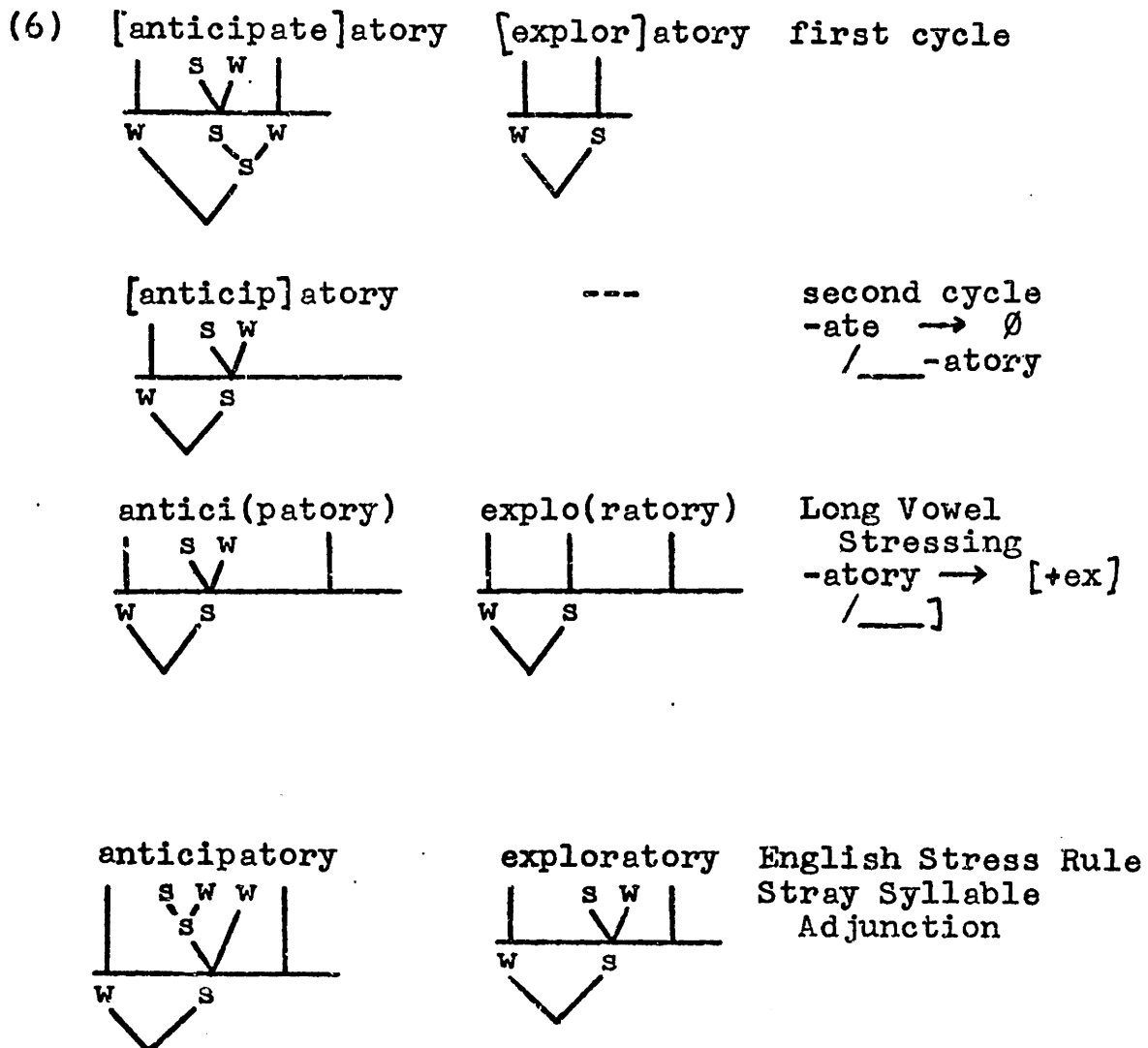

- c. Kalamazóo
 Hardecanúte
 Allamakée
 Illilouétté
 Mattamuskeét
 Antigonísh
 Gallipolís

which is apparently the norm among long monomorphemic words in English. If the rightmost foot of the word is the strongest, as in a, then the foot that precedes it is ternary. If the rightmost foot is weak, the foot that precedes it is binary. The contrast is illustrated in (2):

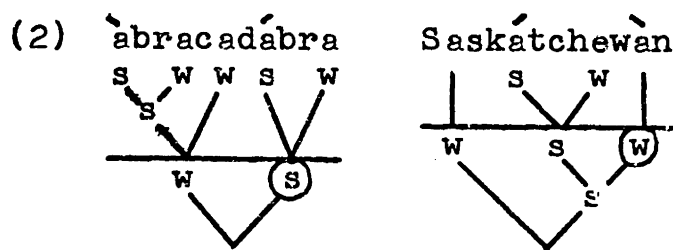

Note that the relevant factor has to be the labeling of the final foot, rather than its syllable count, since in the words of column c, we find that monosyllabic final feet that are idiosyncratically strong occur preceded by ternary feet just like polysyllabic strong final feet.

This relationship initially seems to pose an ordering paradox: the word tree, which establishes the relative prominence of the feet, must surely be drawn after the feet are constructed. But the configuration of the feet seems to

depend here on the labeling of the word tree. Even if the word tree is constructed by adding one foot at a time, along the lines of Liberman and Prince (1977), the paradox persists: since the labeling s w has only a relative meaning, the labeling of the final foot can be accomplished only when the preceding foot with which it is paired has already been constructed.

The theory proposed here offers a way around the paradox. We have assumed that all feet in a word to the left of that assigned by the English Stress Rule are constructed by Strong Retraction, so that at some stage of its derivation a word like abracadabra has the following metrical structure:

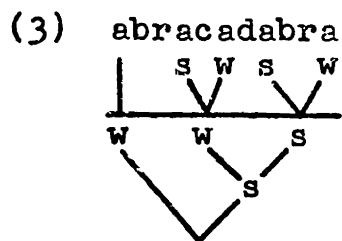

In (3), the rightmost foot has been constructed by the English Stress Rule, the middle one by Strong Retraction, and the leftmost again by Strong Retraction, which may construct non-branching feet when only one syllable is available, by virtue of the Maximal Foot Construction Principle. (3) may be converted to the correct output if we apply a rule that looks like (4):

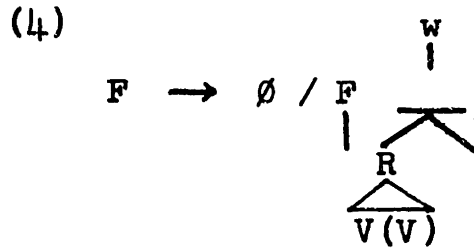

That is, delete a binary foot which is in metrically weak position, which is preceded by a non-branching foot, and whose first syllable is open. (4) would apply to abracadabra as follows:

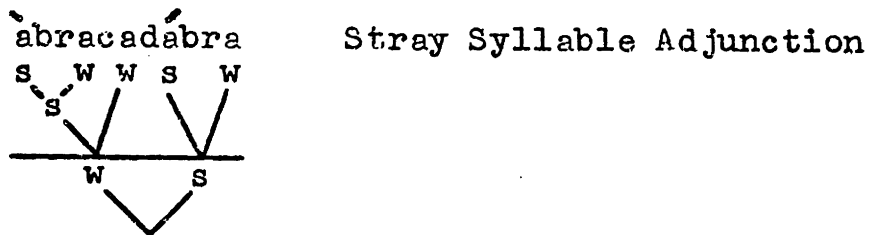
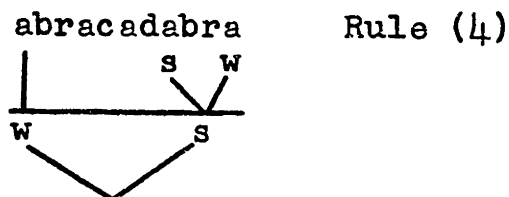
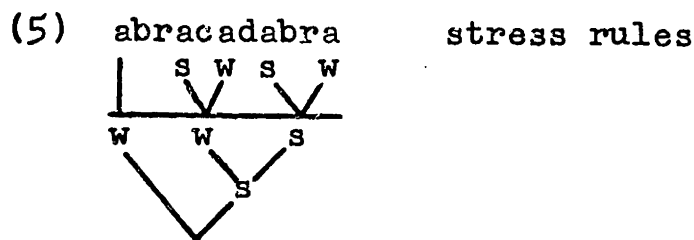

In words like Saskatchewan, however, rule (4) could not apply, since the foot to be removed is in metrically strong position. Thus the analysis captures the distinction between the two classes of words without encountering an ordering paradox.

Interestingly, the rule (4) needed to implement the

solution is already motivated elsewhere: it is the Post-Stress Destressing rule needed to account for the destressed alternants of suffixes like -ory, -ary, and -ative following stressed syllables--cf. advis^ory vs. adm^onit^ory, infirm^oary vs. coroll^oary, altern^oative vs. imit^oative etc. The derivation of a typical case, cursor^oy, is quite parallel to that of abracadabra:

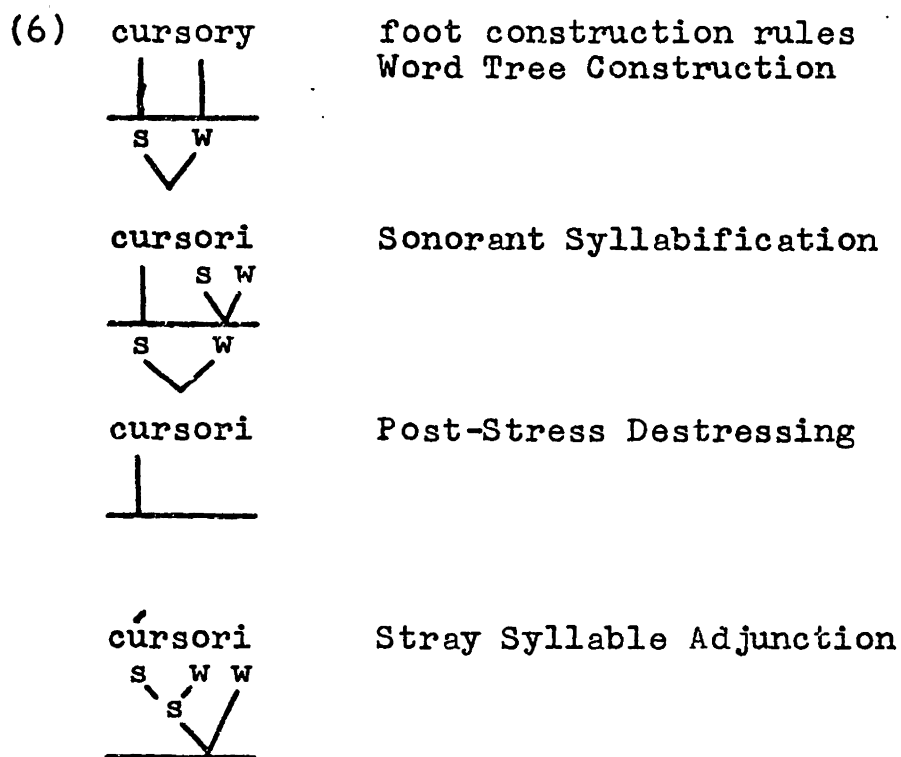

Just as before, a foot must be metrically weak in order to be reduced: cf. McGr^ory, can^oary, creat^oive.

The analysis depends on the assumption that, despite the claims of Liberman and Prince (1977), Post-Stress Destressing is in fact a separate rule from Pre-Stress Destressing, which is formulated on p.260. This seems to be a reasonable claim. First of all, in order to unite the two destressing rules

Liberman and Prince must assume a convention for Stray Syllable Adjunction that doesn't appear to be appropriate for use in other languages: in our framework, it adjoins stray syllables sometimes to a foot, sometimes to the word tree. They also must posit an extra rule of Foot Formation in order to prevent -ory et al. from destressing when occurring after a stressless syllable. Finally, there is at least one morpheme which is an exception to Post-Stress Destressing, but not to Pre-Stress Destressing: many speakers say Hánóver but Hánóverian.

The analysis accounts nicely for an unexplained observation made in Liberman and Prince (1977, p. 276). Whenever stress retraction occurs across a domain of four syllables, the normal case is for two binary feet to be created, rather than a non-branching and a ternary one:

- | | | |
|-----|--------------|------------------|
| (7) | Pòpocàtepétl | Òkalòacóóchee |
| | Àpalàchicóla | Hànamànióa |
| | ìpecàcuána | hàmamèliánthemum |
| | ònomàtopóeia | |

Under our analysis, these cases are completely expected, since it is Strong Retraction, a binary foot construction rule, that erects the non-final feet in the words of (7). The medial feet of these words don't delete, since the feet that precede them branch. The examples of (7) are thus parallel in their behavior to words like prómissòry, apóthecàry, and ìmitàtive.



Another bit of evidence that it is the same rule applying in both contexts is that in both cases, destressing is blocked if the first syllable of the foot to be removed is closed, as in (8):

(8)	Monòngahéla	cárbùncle
	Àtascadéro	áncèstor
	Tìcònderóga	áutòpsy
	Òmpòmpanoósuc	nécròpsy

There are a few words that might suggest that Post-Stress Destressing should be formulated to remove feet whose first syllables are closed as well:

(9)	gálexy	liberty	chivalry
	cýlinder	próvender	índustry

However, it isn't necessary for Post-Stress Destressing to apply to these words at all in order to get the correct output. We can just as well say that their final syllables, including the final /y/ or /r/, are extrametrical, which is the regular case for nouns:

(10)	ga(laksy)	Noun Extrametricality
	ga(laksy)	English Stress Rule
		
	galaksy	Stray Syllable Adjunction
		



Sonorant Syllabification
Stray Syllable Adjunction

Notice that there are cases where this solution is the only one that will work: words like présidency, rélevancy can be derived only with extrametricality, not by Post-Stress Destressing. Cases like intérminable, indómitable, végetable (for those who say [vɛjɔDəbɔl]) similarly show that underlying non-syllabic sonorants that are later syllabified must be counted as part of a preceding extrametrical syllable.

I have mentioned Kiparsky's claim that word trees may be freely constructed as right or left branching, insofar as their shape isn't dictated by the cycle. This proposal is intended to account for the two possible stressings of words like Ticonderoga, Ompompanoosuc, as in (11):

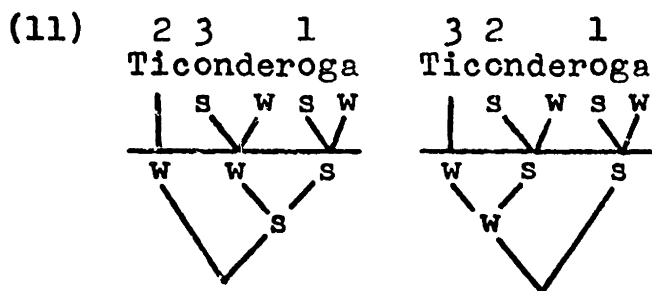

The proposal raises a problem for the present analysis, because if it is true, we would predict stress doublets in words like abracadabra as well:

(12)a. abracadabra

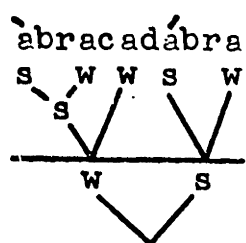
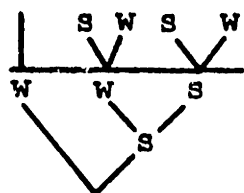

Post-Stress Destressing
Stray Syllable Adjunction

b. abracadabra

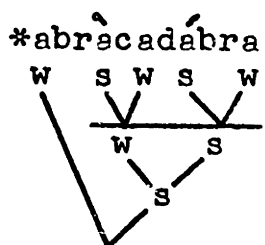
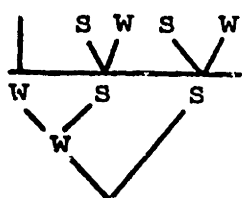

Pre-Stress Destressing

In (12)b, the foot braca would be immune from Post Stress Destressing since it is metrically strong, with the phonetic output *abràcadábra derived by Pre-Stress Destressing. Fortunately for the analysis, it appears that Kiparsky's proposal is wrong, as it makes an incorrect prediction for words that have two final monosyllabic feet, such as Adirondacks,

Massapequod. The left branching word level bracketing:

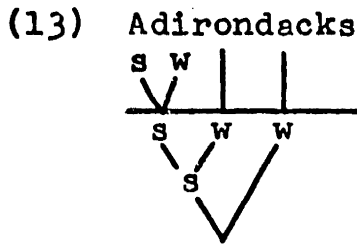

would produce the incorrect stressing *Adirondacks. Thus it appears that word level bracketing in English must always be right branching when it is not determined by the morphology. As for the two possible stressings of Ticonderoga, Ompompanoosuc, there are a number of accounts that one could suggest. As none of them has any great advantage over any other, I will leave the question open here.

Our analysis does provide support for Kiparsky's claim that word tree bracketing is retained throughout the cycle, insofar as it is not altered by foot construction. Notice that morphologically derived long words typically do not display the pattern of secondary stress found in monomorphemic long words; cf. subliminálity vs. òkefenókee, demòcratizátion vs. Àpalàchicóla, Macàssarése vs. Gállipolís. This follows from our formulation of Post-Stress Destressing to apply only to feet in weak position. Compare, for example, the derivations of subliminality and Okefenokee:

(14) [subliminal]ity

first cycle

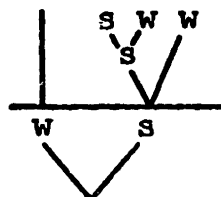

subliminali(ty)

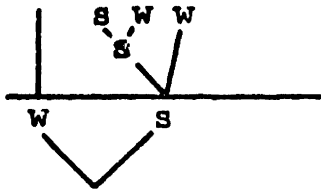

Okefeno(kee)

Noun Extrametricality

subliminality

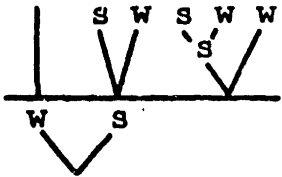

Okefenokee



English Stress Rule
Stray Syllable
Adjunction

Okefenokee



Strong Retraction

subliminality

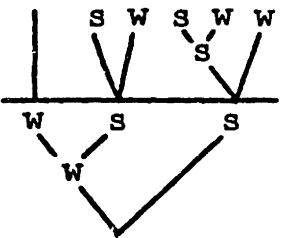

Okefenokee

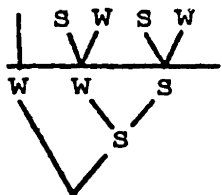

Word Tree Construction

Okefeno^ˈkee

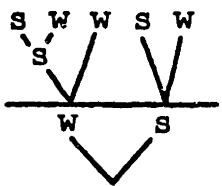

Post-Stress Destressing
Stray Syllable Adjunction

subliminali^ˈty

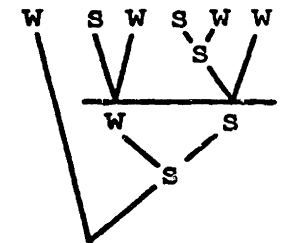

Pre-Stress Destressing

Pre-Stress Destressing from applying as well, since the proper output is Winnepesáukee, not *Winnépésáukee. Our formulation of Stray Syllable Adjunction guarantees this: the rimes liberated by Post-Stress Destressing are automatically adjoined to the preceding foot, since if they were adjoined to the following foot they would not be recessive. The non-branching foot Wi is thereby changed into the branching foot Winnepe, and is rendered immune from Pre-Stress Destressing.

It remains to deal with the exceptions to the generalization of (1). On one hand we find words like Epáminóndas, Atcháfaláya, and Agèsiláus, where a strong final foot is preceded by a binary foot rather than a ternary one. These words must be marked as exceptions to Post Stress Destressing, and are thus similar to words like Hóboken, Rásmússen, prímáry, líbráry. In the other direction we find words like those of (16):

- (16) rígamaròle húllabalòo
 cátamaràn Mánitowòc

A plethora of solutions are available to stress these words, all of which are ad hoc. For example, we might provide a marked minor rule to assign a ternary foot in these words, or exceptionally allow for two word final extrametrical syllables, or allow for some sort of metrical resolution by which the first two syllables are bracketed together into a constituent that counts as terminal for the purposes of the

stress rules, as in (17):

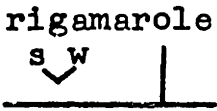
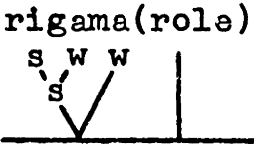
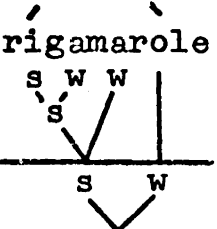
(17)	rigamarole 	underlying form
	rigamarole 	Long Vowel Stressing
	rigama(role) 	Noun Extrametricality English Stress Rule
	rigamarole 	Word Tree Construction

The point is that the means of stressing these words should be somewhat ad hoc, since they are exceptions to the more general pattern exemplified by Mamáronèck, Saskáthewàn, etc. It is interesting that many of the words typified by (16) derive historically from words that were more regularly stressed: for example hullabaloo and catamaran appear in the Oxford English Dictionary with final main stress, so that their secondary stresses could be derived normally. Similarly, rigamaròle is a recently introduced variant of rigmaròle, while rázzamatàzz and tácamahàc alternate in current speech with rázzmatàzz and tácmahàck.

Aside from these examples, however, the analysis here constitutes a fairly good argument in favor of avoiding rules of ternary foot construction: notice that if we did stress

words like Winnepesáukee using such a rule, some ad hoc principle would be required to rule out ternary foot construction in words like Ápalàchicóla. By contrast, the analysis presented here requires no rules to derive the regular cases that are not motivated elsewhere.

With this much of the analysis in hand, we can again pose the question of whether Strong Retraction is adequate to derive all of the stresses lying to the left of the stress assigned by the English Stress Rule. With regard to stresses that on the surface appear to the left of the stress predicted by Strong Retraction, this appears to be true: as we have just seen, the great majority of these surface exceptions are only apparent ones. The other question that must be asked is if there are cases in which stress falls to the right of what would be predicted by Strong Retraction. As far as I know, there is only one such word: Halicárnássus, which we would predict to be stressed in the same way as paraphernália. We can handle the stressing of Halicarnassus by listing it in underlying representation with a non-branching foot over the syllable car, at the same time marking its penultimate rime [+H] in order to get penultimate main stress:

(18)

F
Halicarnassus
[+H]

Its stress derivation would then be

(19) Halicarna(ssus)

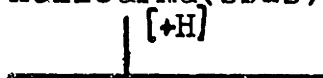

Noun Extrametricality

Halicarnassus



English Stress Rule
Stray Syllable Adjunction

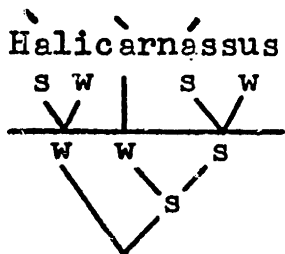

Strong Retraction (N.B.
Structure assigned ear-
lier is preserved.)
Word Tree Construction

The important point about this word, however, is its uniqueness: the fact that examples of this kind should be so rare suggests that we are correct in assuming that stresses to the left of the foot assigned by the English Stress Rule are in general constructed by Strong Retraction. It should be noted that words like chimpanzee, rodomontade are not exceptions to this claim: their penultimate feet can be derived by the English Stress Rule, as follows:

(20) chimpanzee



Long Vowel Stressing

chimpan(zee)

Noun Extrametricality
English Stress Rule

chimpanzée

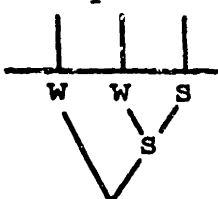
Strong Retraction
Word Tree Construction

Their exceptionality lies in the labeling of their word trees, not in the construction of their feet.

9. A Constraint on Destressing Rules

By now, we have presented four destressing rules in English: Pre-Stress Destressing, Post-Stress Destressing, the Arab Rule, and Sonorant Destressing. The first three all share as part of their environments the expression

W
|

_____. The remaining rule, Sonorant Destressing, requires the condition that the foot to be destressed not be in strong position. It would obviously be a good idea to factor this common restriction out of the individual rules, phrasing it as a more general constraint:

- (1) Destressing rules may not remove feet in strong position.

(1) is simply a generalization of the constraint of Sonorant Destressing, but it will appropriately constrain the other

de-stressing rules as well. Because these rules apply after Word Tree Construction in the cycle, (1) is equivalent to

W
|

adding _____ to their environments.

It is reasonable to suppose that (1) is not confined to English, but is a universal constraint: there are no exceptions to it in this thesis, and it allows us to simplify the de-stressing rule of Tiberian Hebrew (p. 157) as well as the English rules.

10. Prefix-Stem Words and the Strict Cycle

The stressing of Greek-derived words consisting of a prefix and a stem, such as in (1):

(1)	hélicogràph	eléctrogràph
	síderoscòpe	larýngoscòpe
	héteroným	kaléidoscòpe
	plálatinotýpe	hómóným

poses two problems for the proposals I have advanced here. First, when the phonological requirements are met, these words contain ternary feet which are neither at the right edge of a word nor in metrically weak position, hence not derivable by the rules I have presented so far. Second, words of this sort regularly display stress on their final syllables, even though on purely phonological grounds we would often expect stress on a syllable lying further to the left. The situation is complicated by the fact that when suffixes are added to words like those of (1), the final

stems lose their stress, as in (2):

- (2) heterónymous
 pentágonal
 helicógraphy⁶

We therefore cannot account for the stressings in (1) with a simple principle saying that stress may not retract beyond the left boundary of a stem.

The best solution seems to be a return to the proposal made in Chomsky and Halle (1968): that in words like (1), both the prefix and the stem constitute cyclic domains for stress assignment. If we assume that prefixes behave like nouns in the assignment of extrametricality, then we will get stresses assigned in the right places:

- (3) [hete(ro)] [(nym)] first cycle
 Extrametricality
- [hete(ro)] [(nym)] English Stress Rule
- $$\begin{array}{c} s \quad w \\ \diagdown \quad \diagup \\ \hline \end{array}$$
- [hetero] [nym] Stray Syllable Adjunction
 Word Tree Construction
- $$\begin{array}{c} s \quad w \quad w \\ \diagdown \quad \diagup \quad | \\ \hline \end{array}$$

It is in the second cycle that the analysis may initially seem inadequate: why shouldn't the English Stress Rule apply again to produce *heterónym? The answer to this question comes from the Strict Cycle (see Mascaro 1978), which

I formulate as follows:

- (4) A cyclic rule may apply on a cycle j only if it crucially refers to
- a. A string X such that j is the earliest cycle containing it;
 - b. Two strings Y, Z such that j is the earliest cycle that contains both of them;
 - c. A string W which has been modified by a rule applying earlier on cycle j .

The rather wordy formulation of (4) is provided for explicitness; more intuitively we can say that a cyclic rule may apply on cycle j only if it crucially refers to information about the string that is first made available on cycle j . My formulation of the Strict Cycle disagrees with Mascaro's in that it allows rules to apply on the first cycle, which seems to be crucial in handling English stress. It may be a special characteristic of metrical rules to apply on the first cycle; see for example Nash (1980), in which stress in Warlpiri is accounted for by metrical rules that apply first within morphemes, then within words.

Now if (4) is right, let us see what rules could apply to a representation such as (3)c. Under the interpretation of the Strict Cycle that seems most reasonable, the English Stress Rule itself should be able to apply, since in principle it could construct a foot dominating material in both the prefix and the stem, thus satisfying condition b.

However, the extrametricality rules, for both consonants and rimes, would be blocked: the final consonant and the final rime in (3)c lie at the right edge of their stress domain in both the first cycle and the second. The extrametricality rules clearly do not refer crucially to material uniquely in the second cycle. Thus when the English Stress Rule applies to (3)c, it may only restress the final foot vacuously. The representation for heteronym will remain the same.

The word tree rule will of course be free to apply on the second cycle, as it joins together two feet that lie in two different cyclic subdomains. By the normal application of the rule, we get

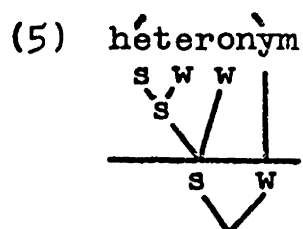

Now if we add a suffix to a prefix-stem word, thus adding a cycle to its derivation, the extrametricality rule will be able to refer to material uniquely in the current cycle:

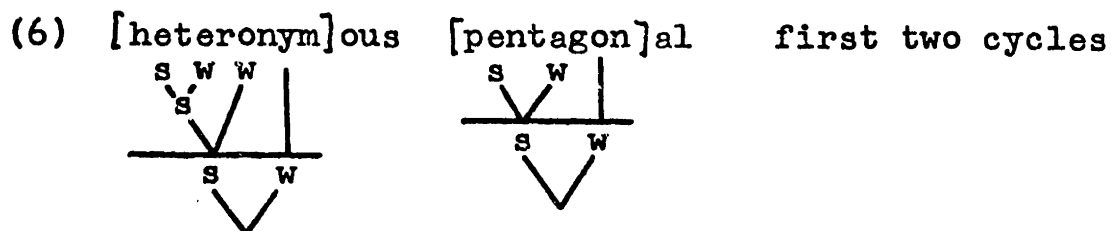

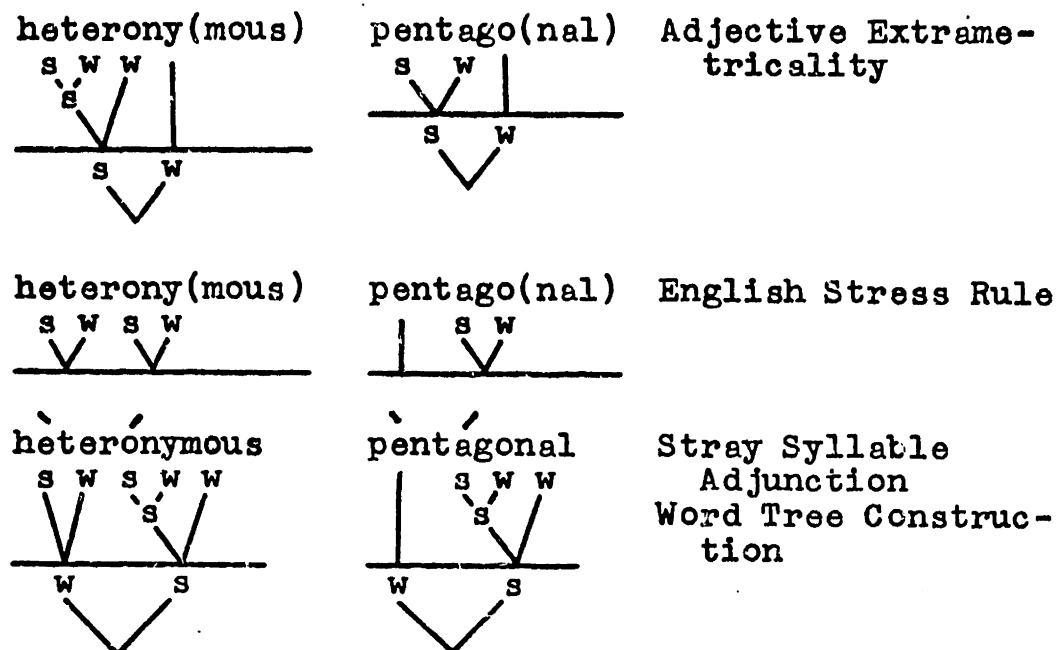

The theory thus accounts for why Greek stems receive stress on the surface only when they are not followed by a suffix. Notice that all we had to stipulate arbitrarily was that prefixes and stems constitute cyclic domains. The other ingredients--i.e. the strict cycle, and the formulation of the stress rules--are motivated elsewhere, or are stipulated in universal grammar.

The rather unusual stress behavior of the Greek nominalizing suffix -y should be mentioned here. Descriptively speaking, this suffix is a weak retractor:

- | | |
|--|---|
| (7)a. hétéronóym-héterónóymy
télegràph-telégràphy | b. állomórfh-állomórfhy
óρθodòx-óρθodòxy |
|--|---|

but with a glitch. When it occurs in a final binary foot, that foot receives secondary stress, as (7)b shows. This can be handled if we make two assumptions: (a) -y is underlying syllabic /i/; (b) it is marked as extrametrical for purposes

of word tree labeling. These assumptions will cause heteronymy and allomorphy to be correctly stressed as follows:

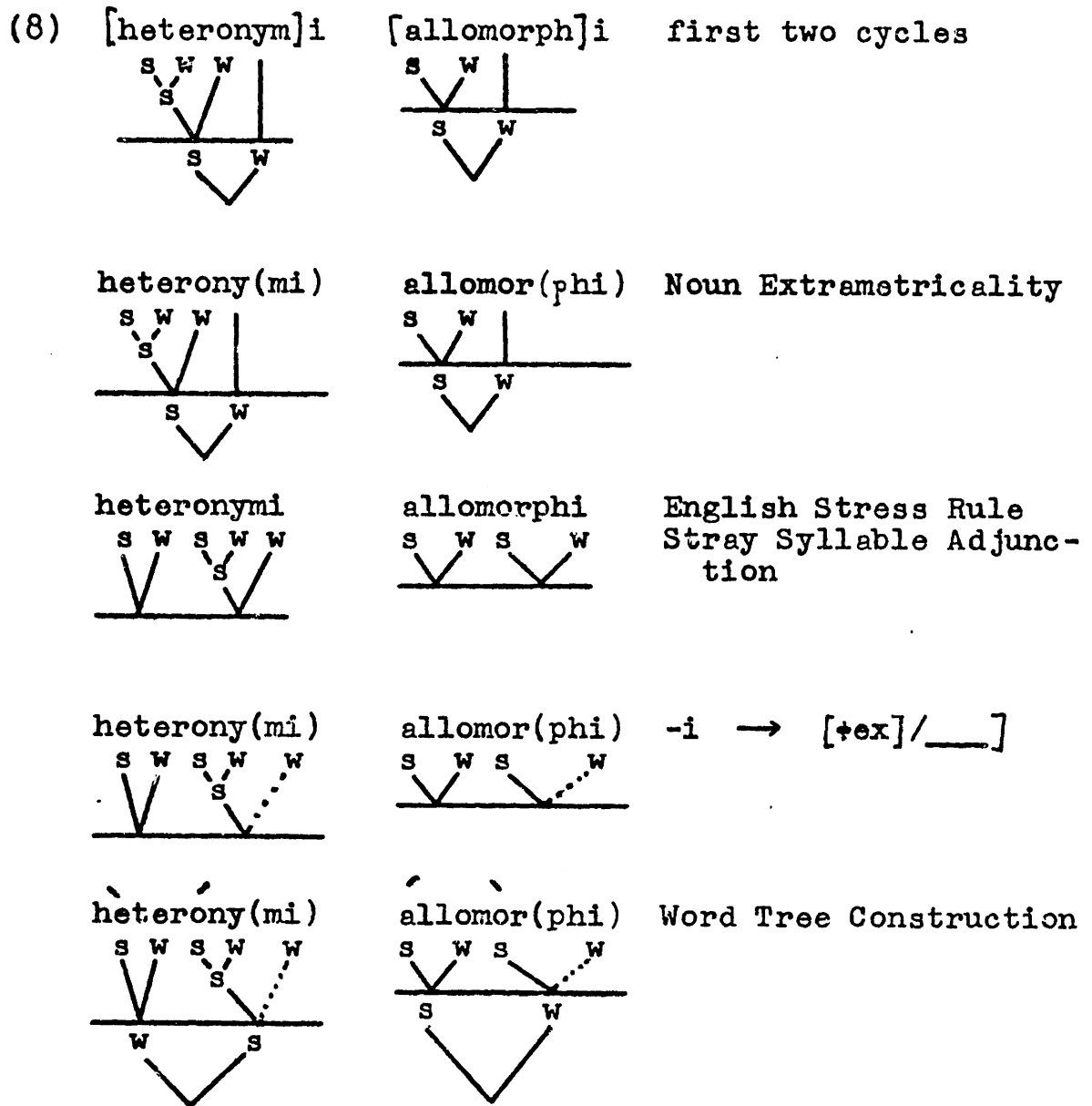

Note that Stray Syllable Adjunction need not and does not apply when -y is made extrametrical late in the derivation-- it is already part of a foot. The extrametricality rule simply specifies that -y should be ignored for purposes of labeling the word tree. In this respect -y extrametricality resembles the rule of Consonant Extrametricality, which

simply excludes a consonant from the domain of the English Stress Rule, rather than actually affecting its syllabification.

The notion of word tree extrametricality propounded here should probably be extended to include words like Ládefòged, pómegrànte and the adjectives in -ative, replacing the diacritic which allowed final branching feet to be labeled as weak. This is not due just to Occam's razor: the extrametricality theory predicts that there are no weak final ternary feet, since a final ternary foot will be labeled as strong even when its final syllable is extrametrical. This prediction is exceptionlessly true, which would be a complete accident under the diacritic analysis.

The main potential defect of this account of the Strict Cycle is the following: if the stress rules must refer to the labeled bracket to the right of the material being stressed, should not the new labeled bracket referred to in each cycle constitute a derived environment, so that the stress rules could apply on all cycles? To be sure, as Mascaro formulated the Strict Cycle only segmental material may constitute a derived environment, but since the two possible interpretations of the Strict Cycle seem equally plausible a priori, we must argue in favor of the one needed here. The only possible counterexample to the claim that I can think of is the case of the Finnish rule $e \rightarrow i / ___\#$, which must precede the demonstrably cyclic rule $t \rightarrow s / ____i$ in derivations such as (9) (Kiparsky 1973a):

- (9) #vete#
 #veti# e → i / ___#
 #vesi# t → s / ___i

In many current theories, word boundaries are represented not as terminal symbols in the phonological string, but as labeled brackets, as in]_{word} (see Selkirk (ms. b), Rotenberg 1978). However, it is important to see that (9) does not prove the rule e → i / ___# to be cyclic--it only shows that it can feed a cyclic rule, t → s / ___i. If we assume that the word level is one of the domains in which cyclic rules may apply, then (9) is not a counterexample to the claim made here. The cyclic rule t → s / ___i may apply on the word level cycle because it refers crucially to the output of a rule applying earlier in the cycle--even though that rule is not cyclic.

However, we need evidence to show that labeled brackets must not constitute environments for cyclic rules. The evidence offered here is the fact that denominal verbs and deverbal nouns usually display the stress pattern of their sources. For example, denominal verbs such as páttérn, évidéncé, mónítór, and díscíplíné are stressed on the nominal pattern of their sources, showing that they did not undergo restressing on their outermost cycle based on the environment /___]v. Similarly, the deverbal nouns adváncé, regárd, regrét show that when a final stressed verb is converted to a noun and receives another cycle in its stress derivation,

A closer look at the facts, however, shows that this is not the case. Virtually every verb-noun pair similar to those of (10) is morphologically composed of a prefix and a stem. One can argue that the pairs of (1) consist not of verbs with their related nouns, but simply verbs and nouns which are derived from the same prefix and stem.⁷ Under this analysis, the derivations of pémit and permit are as under (12):

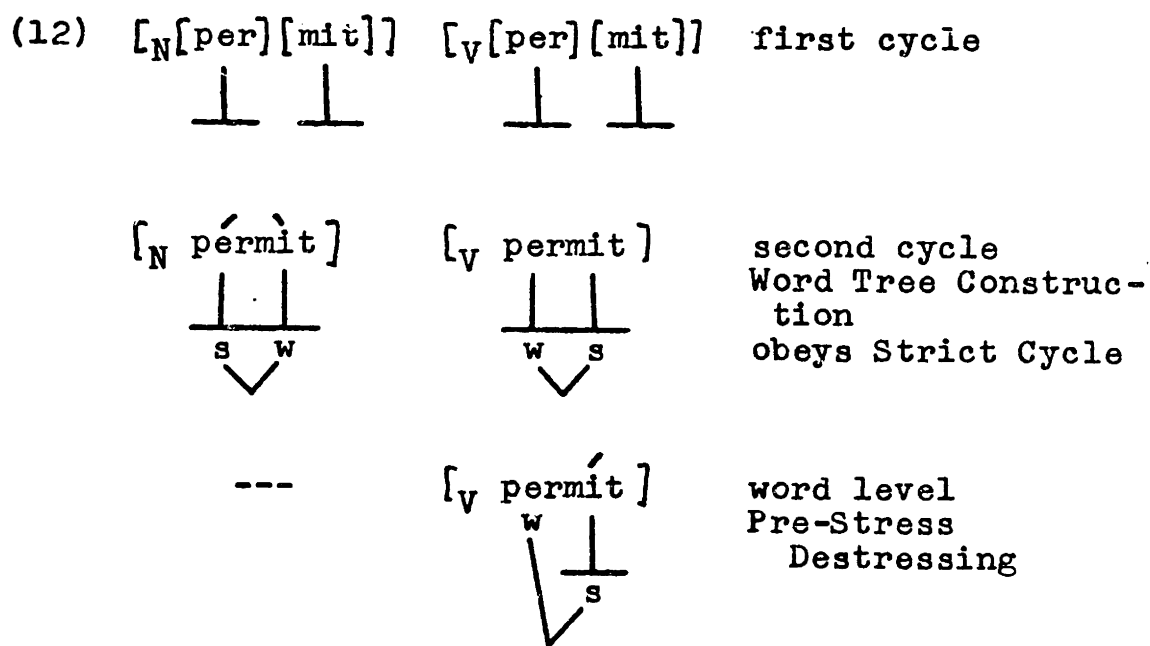

What evidence supports this view? First, there is a fair number of nouns which display the $\acute{x} \grave{x}$ stress pattern, which are not derived from verbs, and would not be expected to receive final secondary stress anyway by virtue of the phonetic composition of their final syllables:

- (13) \acute{a} bsc \grave{e} ss \acute{e} gr \grave{e} ss \acute{i} nc \grave{o} me
 \acute{a} cc \grave{e} ss \acute{e} xc \grave{e} ss \acute{i} ng \grave{r} ess
 \acute{a} dv \grave{e} nt \acute{i} nc \grave{e} st \acute{i} ng \grave{u} est

These would be stressed correctly under my theory, which claims that $\acute{x} \grave{x}$ is the normal stress pattern for all prefix-stem nouns. However, a theory that claimed that $\acute{x} \grave{x}$ is characteristic of deverbal nouns only would have to mark them as exceptions, so that they could receive final secondary stress.

Another argument can be found by examining the noun-verb pairs in which the stress doesn't alternate, as in con-sent_{N,V}, appeal_{N,V}, reform_{N,V}. My theory would regard the nouns of these pairs as actually deverbal, i.e. as having the structure $[_N[_V[_{Pre} X][_{Stem} Y]]]$. If this is so, they will be stressed correctly under the provisions of the Strict Cycle:

(14) $[_N[_V[_{Pre} con][_{Stem} sent]]]$ first cycle

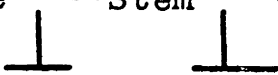

$[_N[_V consent]]$ second cycle
Word Tree Construction



blocked by Strict Cycle third cycle
Word Tree Construction

$[_N[_V \text{ consen}^{\acute{t}}t]]$ word level
Pre-Stress Destressing



Pairs of the type $\text{consént}_V \sim \text{consént}_N$ seem to be roughly as numerous as those of the type $\text{permit}_V \sim \text{pérmít}_N$, but there is an important difference between the two groups: the cases in which the semantic relation between the noun and the verb is remote are far more common among the pairs with stress shift, as (15) suggests:

- | | | |
|--------|--|---|
| (15)a. | ábst`r`act-abstráct | dígèst-digést |
| | áf`f`ect-afféct | éxp`l`oít-exploít |
| | cómb`i`ne-comb`i`ne | íncè`n`se-incè`n`se |
| | cómp`r`ess-compréss | prócè`d`s-procédéé |
| | cóncè`r`t-concér`t (ed) | pród`u`ce-produce |
| | cónsè`r`ve(s)-consérve | prój`e`ct-projéct |
| | défè`c`t-deféct | réf`u`se-refúse |
| b. | exháust _N -exháust _V | presérve(s) _N -presérve _N |
| | revérse _N -revérse _V | |

This is entirely natural under the theory proposed here: if a noun and a verb are related only by virtue of containing the same prefix and stem, we would expect them to have a looser semantic connection than if the noun is directly derived from the verb, i.e. as $[_N[_V[\text{Pre } X][\text{Stem } Y]]]$. The question remains of what happens when a semantically compositional pair displays the stress pattern $x \acute{x}_V, \acute{x} \grave{x}_N$, or when a pair with the pattern $x \acute{x}_V, x \acute{x}_N$ isn't semantically compositional: in dictating the morphological bracketing, does semantics or phonology win out? I will leave this question

open, pointing out only that the theory proposed here does predict the right tendency. A theory that claimed that stress patterns of the type $\acute{x} \grave{x}_N$ are the result of derivation from verbs would if anything make the wrong prediction, since the semantically deverbal nouns more often have the $x \acute{x}$ stress pattern.

The last argument derives from the existence of a fair number of verbs which display the nominal stress pattern, at least for some speakers:

(16)	áccé`nt	co`ntáct	ímpáct	pró`fíle
	állý	co`ntóur	índéx	pró`grám
	clí`max	co`nvoy	pró`cèss	ré`tail
	co`mmé`nt	dí`scóunt		

since these all have a straightforward semantic relationship with their associated nouns, it seems reasonable to derive them as denominal verbs--because of the strict cycle, they retain the nominal stress pattern. Several of the verbs are in fact historically derived from nouns. A nice example of the phenomenon is the verb discount, which is pronounced by many speakers as disco`unt when it means "give little importance to" but as dí`scóunt with the meaning "sell at a discount." The latter instance, which is clearly denominal in meaning, receives its stress correctly under the strict cycle if it is bracketed as $[_V[_N[_{pre} \text{dis}][_{stem} \text{count}]]]$.

In searching for counterexamples to the claims made here, we would want to find noun-verb pairs which were

morphologically simplex, but had the $x \acute{x}_V, \acute{x} \grave{x}_N$ stress alternation. One possible case would be words which contain recognizable Latinate prefixes, but whose stems occur nowhere else in the English lexicon, so that it would be more difficult for the language learner to decompose them morphologically. My complete list of such words is as follows:

- | | | |
|------|---------------------|-----------------|
| (17) | allóy-álloy | decóy-décòy |
| | annéx-ánnèx | explóit-éplóit |
| | combíne-cómbine | invíte-ínvite |
| | contrást-cóntràst | perfúme-pérfúme |
| | concért(ed)-cóncèrt | recrúit-récrúit |

Even if we grant that these words are morphologically unitary (which seems debatable to me), they offer very little support for the theory that $x \acute{x}_V - \acute{x} \grave{x}_N$ alternations are the result of deverbal derivation. For one thing, three of the nouns of (17), combine, concert, and exploit, have meanings which are not predictable from their ostensibly related verbs. Furthermore, all the nouns of (17) except concert and contrast would be expected to receive $\acute{x} \grave{x}$ stressings as nouns even if they weren't derived from verbs: their final syllables attract stress by virtue of having long vowels or typically stress-attracting final clusters (in annex). We would thus derive the right stressings from the lexical representations [_Vinviit], [_Ninviit], without any deverbal derivation.⁸

Aside from the cases with unique stems, very few

examples remain. The pairs escórt_V-éscort_N and essay_V-éssay_N would be counterexamples if es- is considered not to be a prefix, but once again we would expect é é stress in the nouns purely on phonological grounds. The words torment, augment, and ferment might constitute better counterexamples. However, the pair fermént_V-férmént_N is semantically non-compositional, and the verbs torment and augment are pronounced as tórmént and áugmént by many speakers. Given the rarity of these cases, it would seem better simply to mark words such as ferment as exceptions, rather than making them the basis of the general theory. This could be done by assigning them final monosyllabic feet in the representations prior to the application of the stress rules.

To sum up, we have made two assumptions in this section: that prefixes and stems constitute cyclic domains of stress assignment, and that labeled bracketings do not constitute derived environments for the purposes of cyclic rules. These assumptions, coupled with the stress rules proposed here, account for a fair number of the stress properties of prefix-stem words, in both the Greek and Latin derived portions of the lexicon. Despite the prevalence of ternary feet on the surface in Greek prefix-stem words, we found that the restricted foot inventory proposed in Chapter 3 is adequate to account for the facts.

11. Ternary Feet Across $\check{V}\check{V}$ and the i-y Rule

We turn now to the remaining case in which ternary feet occur systematically on the surface in English. In Liberman

and Prince (1977), it is claimed that whenever stress is retracted across a sequence of two adjacent short vowels, the Long mode of stress retraction is selected, no matter what type of stress retraction would be indicated by the morphological environment. For example, váriegàte and detérioràte exhibit Long Retraction, despite the status of -ate as a Strong Retractor; while in méteoròid and Ébionìte, the Weak Retraction characteristic of -oid and -ite is overridden by the presence of ǃǃ.

A closer look at the relevant cases shows that they all fit a pattern much more specific than ǃǃ: in each case the first short vowel is /i/.

(1)	álienàte	méteoròid	gànglionàry
	amélioràte	váriolòid	tóreadòr
	detérioràte	vesúvianìte	
	váriegàte	Ébionìte	
		própionàte	
		étiolàte	

Liberman and Prince list more cases, but these can be handled by devices already presented. Their etoilate is apparently a misprint for etiolate. Chomsky and Halle (1968, hereafter SPE) point out that the appearance of /i/ or /y/ in the environment /C___V is to a large extent predictable by rule, although some degree of dialectal and lexical idiosyncrasy is present. This suggests a means (proposed tentatively in SPE) of accounting for words like deteriorate

and meteoroid, without directly assigning ternary feet. If we assume that when the stress rules apply the surface /i/'s of these words appear as /y/, the correct stressings will result from the ordinary application of the English Stress Rule or Strong Retraction. A later rule is needed to take the /y/'s to /i/'s.

(2) deter[y]orate

English Stress Rule



deter[y]orate

Strong Retraction



deter[y]orate

Strong Retraction (second iteration)

Word Tree Construction

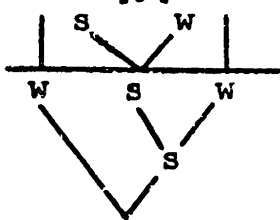

de'tér[i]oràte

y → i
Stray Syllable Adjunction
Pre-Stress Destressing

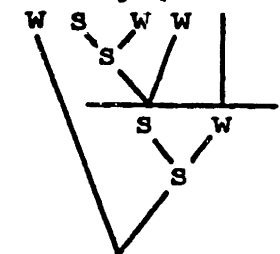

The theory is made plausible by cases in which the /y/ optionally shows up on the surface: ameliorate (amél[i,y]oràte), alienate (ál[i,y]enàte). In addition, there is one case, meridional, in which a quaternary foot is found. This stressing is not derivable at all under Liberman and Prince's theory, but follows nicely from the

underlying representation merid[y]onal under the suggested analysis.

In order to make our solution work, we must (a) Assume that all /i/'s in the relevant positions are underlyingly /y/; (b) Show that the later rule which governs the surface distribution of /i/ and /y/ goes in the direction y to i rather than i to y. The latter task is especially important, since in SPE it was proposed that the rule goes in the opposite direction.

The reason why SPE assumed an /i/ to /y/ rule was to account for the behavior of suffixes like -ion and -ious, which always assign stress to the immediately preceding syllable. Under SPE's theoretical framework, this would follow only if these suffixes had underlyingly bisyllabic forms such as /i[̥]n/ and /ios/, so that two syllables would be available for the stress rule to skip across. However, under the theory assumed here, stress rules are based on syllable quantity, so that representations like /y[̥]n/ and /yos/ will do just as well. At the relevant stage of the derivation, no syllable-initial Cy clusters exist in English, so that any C[̥]VC sequence preceding /y[̥]n/ or /yos/ will count as a closed syllable, and will thus receive stress just like any other heavy penult. Because of this, the behavior of suffixes like -ion and -ious can't be taken as an argument against assuming a /y/ to /i/ rule.

In fact one can argue that the rule must have the form y → i. Notice first that there are a fair number of environments in which /i/ always appears. These are listed under (3):

(3) i / [d, t, r, θ] ___ V	invidious, Poinsettia, imperial, Cynthia
i / n+ ___ +V	centennial, felonious, colonial
i / + ___ um	gallium, titanium, ammonium
i / [^C ___ -cor] ___	Vesuvianite, champion, Kentuckian
i / [F ___	delineate, pecuniary, teleology

The last environment of (3) would in more traditional terms be expressed as / ___ $\left[\begin{array}{c} V \\ +stress \end{array} \right]$. We also find that in the environment / \bar{V} l___, /i/ and /y/ are in free variation: Ame[i]a-Amel[y]a, al[i]enate-al[y]enate, paraphernal[i]a-paraphernal[y]a, etc. Elsewhere, the distinction is usually not predictable, as (4) shows:

(4) California	Lithuania
petunia	schizophrenia
rebellious	filial
familiar	cilia
Norwegian	Glaswegian
contagious	vestigial

There is one environment, however, where /y/ seems to be the norm:

- (5) y / ___ \check{V} n# onion, batallion, million,
rebellion

From the evidence presented so far, one might imagine that these regularities would best be captured by lexical redundancy rules. But there is good evidence that the rules must be ordered, in that they override one another in a systematic fashion. For example, the three relevant /i/ environments of (3) always override the /y/ environment of (5):

- (6) i / [d,t,r, θ]___V Kantian, accordion,
criterion, Pythian
i / n+___+V Newtonian, Oxonian,
Darwinian
i / $\left[\begin{array}{c} C \\ -cor \end{array} \right]$ ___V champion, Vivian, Parseghian

The other two environments of (3) override the systematic optionality characteristic of / \bar{V} l___:

- (7) i / +___um helium, endothelium, scholium
i / [\bar{F} ___] foliation, polio, oleander

The environment / \bar{V} l___ in turn overrides the environment /___ \check{V} n# in chameleon (=chamel[y]on, chamel[i]on). Assuming that lexical redundancy rules cannot be ordered, the only way we can account for these facts is by assuming that at least (8)a and b are phonological rules, going in the direction

y to i.

(8)a. $y \rightarrow i / \bar{V}1 _ V$ (optional)

b. $y \rightarrow i$ $\left\{ \begin{array}{l} [d, t, r, \theta] _ V \\ + _ um \\ n+ _ +V \\ [F _ V \end{array} \right\}^9$

(8)a must be ordered before (8)b to account for the facts of (7). Both rules follow (9):

(9) $\left[\begin{array}{l} -cons \\ +high \\ -back \end{array} \right] \rightarrow [-syll] / _ \check{V}n\#$

which may be regarded as a lexical redundancy rule, as no phonological rule needs to precede it. Notice that this solution will only work if the rules go in the direction y to i.

Another argument can be based on words like beneficiary, auxiliary. These words have two possible pronunciations, one with /i/ and a full, stressed vowel in -ary, the other with /y/ and a reduced vowel in -ary. (In beneficiary /y/ is deleted by a later rule.) In SPE, these variants are generated by varying the conditions on the i to y rule, which is formulated in essence as follows:

(10) $i \rightarrow y / \left[\begin{array}{l} C \\ +cor \end{array} \right] _ \left[\begin{array}{l} V \\ \alpha stress \end{array} \right]$

Conditions: $\alpha = -$, or $\alpha \neq 1$

When α is specified as $\neq 1$, we derive $\text{auxil}[\text{y}\text{ə}]ry$ and $\text{benefi}[\text{š}\text{ə}]ry$ as follows:

(11)	$\text{auxil}[\text{i}]^1\text{ary}^2$	$\text{benefic}[\text{i}]^1\text{ary}^2$	
	$\text{auxil}[\text{y}]^1\text{ary}^2$	$\text{benefic}[\text{y}]^1\text{ary}^2$	$i \rightarrow y$
	$\text{auxil}[\text{y}]^1\text{ary}^0$	$\text{benefic}[\text{y}]^1\text{ary}^0$	Post-Stress Destressing
	$\text{auxil}[\text{y}\text{ə}]^1ry$	$\text{benefi}[\text{š}\text{ə}]^1ry$	Other Rules

But when α is set at $-$, the $i \rightarrow y$ rule will be unable to apply. Since the /i/ remains syllabic, Post-Stress Destressing will also be blocked, with the surface forms $\text{auxil}[\text{i}]ry$ and $\text{benefic}[\text{i}]ry$ resulting.

Forms like emaciate, however, always contain /i/, a problem which is solved ingeniously in SPE. Under the SPE system, the suffixes -ary and -ate are both assigned main stress early in the derivation. Stress is then retracted to the left, by the Stressed Syllable Rule in the case of -ary and by the Alternating Stress Rule in the case of -ate. The $i \rightarrow y$ rule is in fact ordered between the Stressed Syllable Rule and the Alternating Stress Rule, so that when it applies -ary has secondary stress and -ate has primary stress. It thus follows from the formulation of the rules that in both dialects only /i/ can appear before -ate, whereas both /i/ and /y/ can appear before -ary in different dialects.

The SPE analysis is ingenious, but can be shown to be wrong on two counts. A minor point is that there are probably not two separate "dialects" with regard to the

The examples above ending in -ose are particularly illuminating. Although after palatal consonants /y/ is by far the more common phonetic output, the first three examples show /i/. The fourth example fails to show the optional variant /y/ characteristic of the context / $\bar{V}l$ ____ . These words are rare, but the argument they provide is strong, since the pronunciations that are predicted to be possible by the SPE theory ([riylíjòws], [ówsòws], [jiynyáy], etc.) are totally implausible. The prevalence of /i/ over /y/ before stressed vowels in English is virtually exceptionless, a fact which the SPE analysis fails to account for in claiming that Weak Retractors are systematically allowed to have /y/.

It seems likely that what distinguishes -ary from other tense suffixes in its ability to be preceded by /y/ is the fact that it has a stressless alternant derived by Post-Stress Destressing. Notice, for example, that the suffix -ative, which may also be destressed by Post-Stress Destressing, appears to take part in parallel alternations: ini[š̥iə]tive-ini[š̥ə]tive and appre[š̥iə]tive-appre[š̥ə]tive derive from earlier ini[š̥i]ative-ini[š̥y]ative and appre[š̥i]ative-appre[š̥y]ative by the rule destressing -ative in the environment / V [+son] _o ____ (Nanni 1977) and the rule deleting /y/ after palatals. This property of -ary and -ative can be exploited in our analysis by ordering the vocalization rule (8)b freely with respect to Post-Stress Destressing. The two versions of auxiliary, for example, will then be derived as follows:

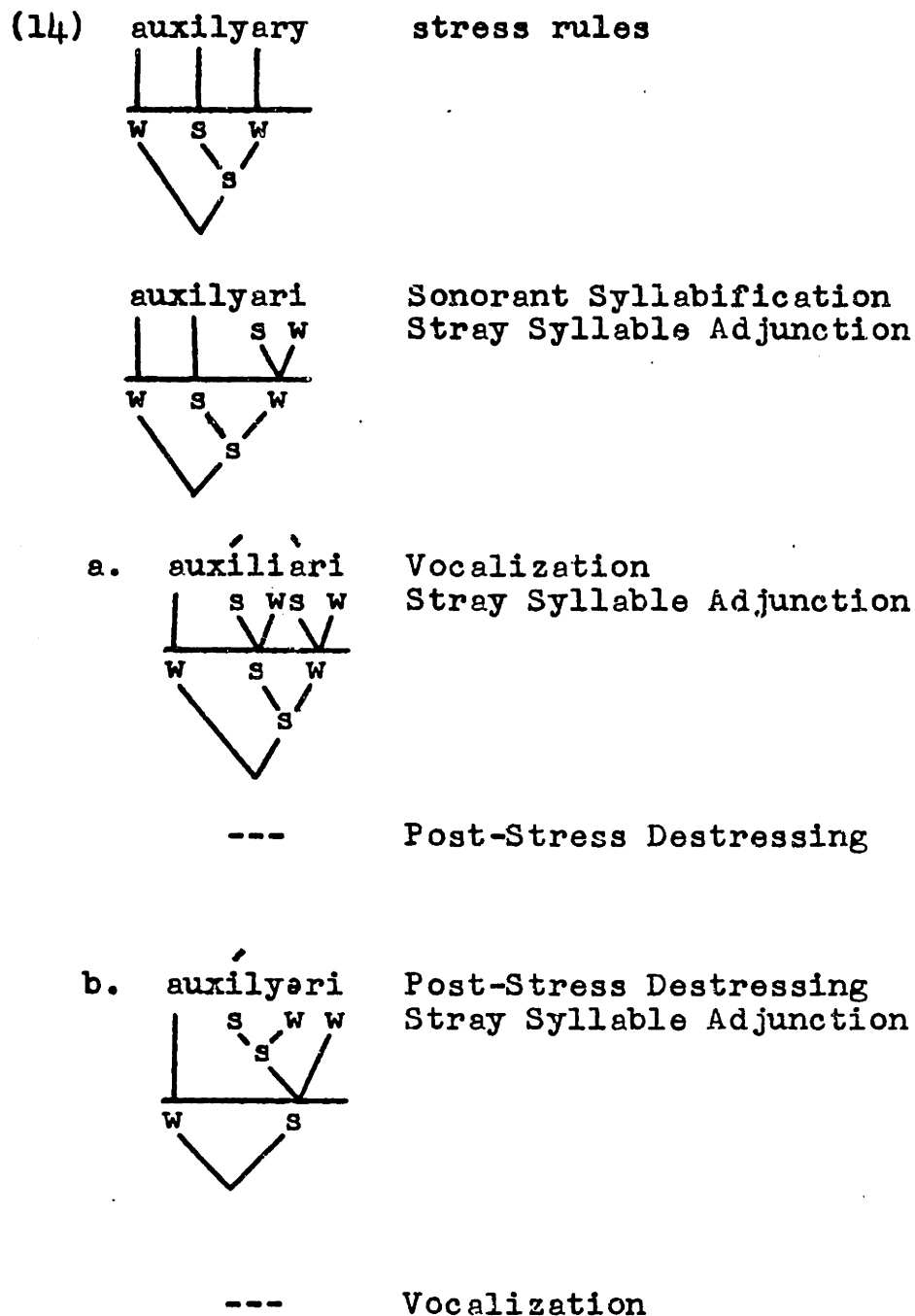

The two rules bleed each other, producing the correct results. In words like emaciate, genii, the final syllable can never be destressed (since it is in a non-branching foot), so that /y/ always vocalizes. Note that a comparable analysis using an /i/ to /y/ rule would be impossible: there is no way that -ary could be made to destress after stressless syllabic /i/;

nor is there a principled means of converting /i/ to /y/ in the environment / [F ___] only before affixes which happen later to undergo Post Stress Destressing. An /i/ to /y/ analysis would thus predict auxil[i]ary as the only possible pronunciation.

The theory advocated here provides a simple account of words that always display /i/, such as pecuniary. These need merely be listed in the lexicon with /i/ underlying. With this representation, Post-Stress Destressing will never be able to apply, even in the ordering where it precedes Vocalization. Notice that it would be impossible for the theory to describe a word which always had /y/, since the Vocalization, Post-Stress Destressing ordering will always produce the /i/ variant at least as an option. As noted above, this seems to be in accord with the facts. Some speakers profess a definite preference for /y/ in certain words. The theory would claim that for these speakers the ordering Post-Stress Destressing, Vocalization is strongly preferred, and that their particular pronunciations of -iary words have crystallized by being encoded in the lexicon with underlying /i/ or /y/.

We see, then, that there is good evidence that the regularity in the distribution of /y/ and /i/ is due to a rule of vocalization, not devocalization. Because of this, we don't need an ad hoc rule of ternary foot construction for words like meteoroid and deteriorate--the stressing of these words is the consequence of independently motivated

rules, given the underlying representations met[y]oroid,
deter[y]orate.

12. Conclusion

I infer from the preceding sections that the effort to remove rules of ternary foot construction from English has by and large been a success. Most of the new theories that were proposed to eliminate a rule of ternary foot construction turned out to have favorable consequences elsewhere in the phonology. The partition of the stress rules into Extrametricality, the English Stress Rule, Long Vowel Stressing, and Strong Retraction, which was originally proposed to account for word final ternary feet, allowed us to avoid marking suffixes for the mode of retraction they trigger, and provided a better theory of how the stress rules apply in the cycle. The extension of Post-Stress Destressing to account for words like Winnepesáukee provided an explanation for stress assignment in forms like Ápalàchicóla. The use of the Strict Cycle to account for ternary feet in Greek prefix-stem words had useful consequences in the stressing of deverbal nouns and denominal verbs. Finally, the use of a y to i rule to form the ternary feet of words like deteriorate led to a better understanding of the i-y alternation and of the derivation of words like auxiliary. These improvements suggest that trying to eliminate rules of ternary foot construction may be a fruitful strategy in other languages, and that the facts of English in general support the model of tree geometry proposed here.

Footnotes to Chapter 5

¹The word tree labeling rules of English are such that the fourth possible case, a strong ternary foot in final position, is excluded.

²The surface exceptions to this generalization have been explained elsewhere in the literature. Words like férvidness, Míchelson contain an internal word boundary. Words like gálexy, chívalry end in an underlying /y/ glide which is later syllabified, so that when the stress rule applies they are bisyllabic. Finally, cases like ádjéctive, désignate_N illustrate the application of a late rule shortening the vowel of the suffixes -ive and -ate_N before word boundary (compare ádjéctíval, désignate_V.)

³I have assumed arbitrarily that the syllable rimes of English are left branching.

⁴Elephantine will actually have a cyclic derivation, as discussed below. The effects of the earlier cycle will not be relevant to the argument made here.

⁵I assume that the suffix spelled as -ion is phonologically /yǃn/. This assumption is justified in Section 11.

⁶Stress shifts such as mícroscòpe-mícróscopy, íchthyopháge-íchthyóphagy seem to violate the phonological requirements on stress placement. For these words we must posit an allomorphy rule shortening the vowel of a stem before a suffix. This rule is fairly well attested elsewhere,

in alternations such as presíde-président, precéde-précedent, cárnivòre-carnivorous.

⁷A proposal roughly along these lines appears in Lieber (forthcoming). Lieber goes further, however, in claiming that even those noun-verb pairs which do not display a stress alternation, such as demánd_{V,N}, are derived separately rather than the noun from the verb.

⁸The words annex and alloy would in fact normally be stressed as annéx, alloy, since their initial rimes don't branch (see p. 234). Thus they are exceptional under either theory.

⁹Contrary to SPE, I have assumed that the presence of a morpheme boundary in the left environment is not necessary in order for /y/ to appear in the output; cf. cases like Califor-
nia, Patricia. SPE also assumes that /y/ is possible after /d,t/, but in every such case, Spirantization (p. 229) applies to the output, as in division, contrition. When i to y fails to apply, we get words like Poinsettia, quotidian, since Spirantization applies only in the environment /___yV, not /___iV. I have assumed that Spirantization is in fact ordered before the rule governing the distribution of /i/ and /y/, and that words like Poinsettia, quotidian are marked as exceptions to Spirantization, not to a putative i to y rule. This has empirical support: under the SPE system we would expect words like quotidian to undergo i to y in the regular environment / ___ǃn#, thus surfacing as *quotidi[ǃə]n by Spirantization and other rules.

Bibliography

- Abaev, V. I. (1964) A Grammatical Sketch of Ossetic, Indiana University Center in Anthropology, Folklore, and Linguistics, Bloomington, Indiana.
- Allen, W. S. (1973) Accent and Rhythm, Cambridge University Press, Cambridge, England.
- Anderson, J. M., and C. Jones (1974) "Three Theses Concerning Phonological Representations," Journal of Linguistics 10, 1-26.
- Anderson, S. (1974) The Organization of Phonology, Academic Press, New York.
- Armbruster, C. (1960) Dongolese Nubian: a Grammar, Cambridge University Press, Cambridge, England.
- Aronoff, M. (1976) Word Formation in Generative Grammar, Linguistic Inquiry Monograph No. 1, MIT Press, Cambridge, Mass.
- Blake, B. (1969) The Kalkatungu Language, Australian Institute of Aboriginal Studies, Canberra.
- Boxwell, H., and M. Boxwell (1966) "Weri Phonemes," in S. A. Wurm, ed., Papers in New Guinea Linguistics No. 5, Australian National University, Canberra, pp. 77-93.
- Bunn, G., and R. Bunn (1970) "Golin Phonology," in Pacific Linguistics, Series A, No. 23, Australian National University, Canberra, pp. 1-7.
- Carlson, L. (1978) "Stress in Finnish," unpublished manuscript, MIT, Cambridge, Mass.
- Chai, N. (1971) A Grammar of Aklan, unpublished Doctoral dissertation, University of Pennsylvania, Philadelphia.
- Chomsky, N., and M. Halle (1968). The Sound Pattern of English, Harper and Row, New York.
- Churchward, C. M. (1940) Rotuman Grammar and Dictionary, Australian Medical Publishing Co.
- Crowley, T. (1978) The Middle Clarence Dialects of Banjalong, Australian Institute of Aboriginal Studies, Canberra.
- Dixon, R. M. W. (1977a) "Some Phonological Rules in Yidin^y," Linguistic Inquiry 8, 1-34.

- Dixon, R. M. W. (1977b) A Grammar of Yidin^y, Cambridge University Press, Cambridge, England.
- Freeland, L. S. (1951) Language of the Sierra Miwok, Memoir 6 of International Journal of American Linguistics, Indiana University, Bloomington, Indiana.
- Fudge, E. C. (1969) "Syllables," Journal of Linguistics 5, 253-286.
- Furby, C. (1974) "Garawa Phonology," Pacific Linguistics, Series A, No. 37, Australian National University, Canberra.
- Goldsmith, J. (1976) Autosegmental Phonology, unpublished Doctoral dissertation, MIT. Reproduced by the Indiana University Linguistics Club, Bloomington, Indiana.
- Goodman, M. (1967) "Prosodic Features of Bravanese, a Swahili Dialect," Journal of African Languages 6, 278-284.
- Haas, M. (1977) "Tonal Accent in Creek," in L. Hyman, ed., Studies in Stress and Accent, Southern California Occasional Papers in Linguistics No. 4, University of Southern California, Los Angeles, pp. 195-208.
- Hale, K., and J. White Eagle (1978) "A Preliminary Metrical Account of Winnebago Accent," to appear in International Journal of American Linguistics.
- Halle, M. (1977) "Tenseness, Vowel Shift, and the Phonology of the Back Vowels in Modern English," Linguistic Inquiry 8, 611-625.
- _____, and S. J. Keyser (1971) English Stress: Its Form, its Growth, and its Role in Verse, Harper and Row, New York.
- _____, and P. Kiparsky (1979) Review of P. Garde, Histoire de l'accentuation slave, unpublished manuscript, MIT, Cambridge, Mass.
- Hayes, B. (1978) "Constraints on Stress Retraction and the History of the English Stress Rule," unpublished manuscript, MIT, Cambridge, Mass.
- _____, (1979a) "Vowel Harmony in Eastern Cheremis," unpublished paper, MIT, Cambridge, Mass.
- _____, (1979b) "Extrametricity," in K. Safir, ed., MIT Working Papers in Linguistics, Vol. 1, pp. 77-87.

- Howard, I. (1972) A Directional Theory of Rule Application in Phonology, unpublished Doctoral dissertation, MIT, Cambridge, Mass.
- Hyman, L. (1977) "On the Nature of Linguistic Stress," in L. Hyman, ed., Studies in Stress and Accent, SCOPIL 4, University of Southern California, Los Angeles.
- Itkonen, E. (1955) "Über die Betonungsverhältnisse in den finnisch-ugrischen Sprachen," Acta Linguistica Academiae Scientiarum Hungaricae 5, 21-34.
- Ingemann, F., and T. Sebeok (1961) An Eastern Cheremis Manual, Indiana University, Bloomington, Indiana.
- Jensen, J. T. (1974) "A Constraint on Variables in Phonology," Language 50, 675-685.
- _____ (1977) Yapese Reference Grammar, University Press of Hawaii, Honolulu.
- Jeanne, L. (1978) Aspects of Hopi Grammar, unpublished Doctoral dissertation, MIT, Cambridge, Mass.
- Johnson, C. D. (1972) Formal Aspects of Phonological Theory, Monographs on Linguistic Analysis 3, Mouton, The Hague.
- Kahn, D. (1976) Syllable-Based Generalizations in English Phonology, unpublished Doctoral dissertation, MIT, Cambridge, Mass.
- Kenstowicz, M. and C. Kisseberth (1977) Topics in Phonological Theory, Academic Press, New York.
- Kenyon, J. S., and T. A. Knott (1953) A Pronouncing Dictionary of American English, G. & C. Merriam Company, Springfield, Mass.
- Kiparsky, P. (1966) "Über den deutschen Akzent," Studia Grammatica 7, 69-98.
- _____ (1973) "Elsewhere in Phonology," in S. Anderson and P. Kiparsky, eds., A Festschrift for Morris Halle, Holt, Rinehart, and Winston, New York.
- _____ (1973a) "Phonological Representations," in O. Fujimura, ed., Three Dimensions in Linguistic Theory, TEC Publishing Co., Tokyo.
- _____ (1977) "The Rhythmic Structure of English Verse," Linguistic Inquiry 8, 189-247.

- Kiparsky, P. (1979) "Metrical Structure Assignment is Cyclic," Linguistic Inquiry 10, 421-441.
- Kirton, J. F. (1977) "Angula Phonology," Pacific Linguistics, Series A. no. 10, Australian National University, Canberra.
- Kisseberth, C., and M. I. Abasheikh (1974) "Vowel Length in Chi-Mwi:ni--A Case Study of the Role of Grammar in Phonology," in A. Bruck, R. Fox, and M. LaGaly, eds., Papers from the Parasession on Natural Phonology, Chicago Linguistic Society.
- Krueger, J. R. (1961) Chuvash Manual, Indiana University, Bloomington, Indiana.
- Larsen, R. S., and E. V. Pike (1949) "Huasteco Intonations and Phonemes," Language 25, 268-277.
- Lehiste, I. (1970) Suprasegmentals, MIT Press, Cambridge, Mass.
- Liberman, M. (1975) The Intonational System of English, unpublished Doctoral dissertation, MIT, Cambridge, Mass.
- _____, and A. Prince (1977) "On Stress and Linguistic Rhythm," Linguistic Inquiry 8, 249-336.
- Lieber, R. (forthcoming) On the Organization of the Lexicon, Doctoral dissertation, MIT, Cambridge, Mass.
- Lunt, H. (1952) A Grammar of the Macedonian Literary Language, Skopje.
- Manning, M., and N. Jagers (1977) "A Tentative Phonemic Analysis of Ningil," in R. Loving, Phonologies of Five Papua New Guinea Languages, Summer Institute of Linguistics, Ukarumpa, Papua New Guinea.
- Mascaro, J. (1978) Catalan Phonology and the Phonological Cycle, unpublished Doctoral Dissertation, MIT, Cambridge, Mass. Reproduced by the Indiana University Linguistics Club.
- McCarthy, J. (1979a) Formal Problems in Semitic Phonology and Morphology, unpublished Doctoral dissertation, MIT, Cambridge, Mass.
- _____, (1979b) "On Stress and Syllabification," Linguistic Inquiry 10, 443-466.

- McArthur, H., and L. McArthur (1956) "Aguacatec (Mayan) Phonemes in the Stress Group," International Journal of American Linguistics 22, 72-76.
- McCawley, J. (1974) Review of The Sound Pattern of English, International Journal of American Linguistics 40, 50-88.
- Meerendonk, M. (1949) Basic Gurkhali Grammar (no publisher given).
- Nanni, D. (1977) "Stressing Words in -Ative," Linguistic Inquiry 8, 752-763.
- Nash, D. (1979) "Yidin^y Stress: a Metrical Account," in E. Batistella, ed., Proceedings of the Ninth Annual Meeting of the North East Linguistic Society, CUNYForum nos. 7-8.
- _____ (1980) "Warlpiri Stress," unpublished manuscript, MIT, Cambridge, Mass.
- Nicholson, R., and R. Nicholson (1962) "Fore Phonemes and their Interpretation," Oceanic Linguistic Monographs No. 6, University of Sydney.
- Odden, D. (1977) "Overspecification and Variables in Phonology," Linguistic Analysis 3, 177-196.
- Oehrle, R. (1971) "Some Remarks on the Role of Morphology in the Assignment of Stress," unpublished paper, MIT, Cambridge, Mass.
- Osborn, H. (1966) "Warao I: Phonology and Morphophonemics," International Journal of American Linguistics 32, 108-123.
- Pesetsky, D. (1979) "Menomini Quantity," in K. Safir, Ed., MIT Working Papers in Linguistics, Vol. 1, pp. 115-139.
- Pike, K. (1964) "Stress Trains in Auca," in D. Abercrombie, ed., In Honour of Daniel Jones, Longmans, London.
- Pike, K., and E. Pike (1947) "Immediate Constituents of Mazateco Syllables," International Journal of American Linguistics 13, 78-91.
- Prince, A. (1975) The Phonology and Morphology of Tiberian Hebrew, unpublished Doctoral dissertation, MIT, Cambridge, Mass.
- _____ (1976) "Applying Stress," unpublished manuscript, University of Massachusetts, Amherst.

- Ramstedt, G. J. (1902) Bergtscheremissische Sprachstudien,
Memoires de la societé finno-ugrienne 17, Helsinki.
- Reinisch, L. (1903) Die Somali-Sprache III: Grammatik,
Alfred Holder, Vienna.
- Ross, J. (1972) "A Reanalysis of English Word Stress," in
M. K. Brame, ed., Contributions to Generative Phonology,
University of Texas Press, Austin and London, 229-323.
- Rotenberg, J. (1978) The Syntax of Phonology, unpublished
Doctoral dissertation, MIT, Cambridge, Mass.
- Safir, K. (1979) "Metrical Structure in Capanahua," in K.
Safir, ed., MIT Working Papers in Linguistics, Vol. 1,
Cambridge, Mass., pp. 95-114.
- Sapir, E. (1930) Southern Paiute, a Shoshonean Language,
Proceedings of the American Academy of Arts and Sciences,
Vol. 65, nos. 1-3.
- _____, and M. Swadesh (1960) Yana Dictionary, University of
California Publications in Linguistics, no. 22, Berkeley
and Los Angeles.
- Schultz-Lorentzen, (1945) A Grammar of the West Greenlandic
Language, C. A. Reitzel, Copenhagen.
- Seidel, A. (1900) "Die Sprache von Ufiomi in Deutsch-
Ostafrika," Zeitschrift für afrikanische und oceanische
Sprachen 5, 165-175.
- Selkirk, E. (forthcoming) "On the Role of Prosodic Categories
in English Word Stress," to appear in Linguistic Inquiry
11.3.
- _____
(ms. a) "The Phonological Structure of English,"
unpublished manuscript, University of Massachusetts,
Amherst, Mass.
- _____
(ms. b) "Prosodic Domains in Phonology: Sanskrit Sandhi
Revisited," unpublished manuscript, University of Massa-
chusetts, Amherst, Mass.
- Shürmann, C. W. (1844) A Vocabulary of the Parnkalla Language,
George Dehane, Adelaide, Australia.
- Sjögren, J. (1861) Livische Grammatik nebst Sprachproben,
Commissionäre der Kaiserlichen Akademie der Wissen-
schaften, St. Petersburg.

- Striade, D. (1979) "Degenerate Syllables and the Accentual System of Ancient Greek," unpublished manuscript, MIT, Cambridge, Mass.
- Stowell, T. (1979) "Stress Systems of the World, Unite!" in K. Safir, ed., MIT Working Papers in Linguistics, Vol. 1, Cambridge, Mass., pp. 51-76.
- Strauss, S. (1979) "Stress Assignment as Morphological Adjustment in English," paper read at the 1979 Winter Meeting of the Linguistic Society of America, Los Angeles.
- Street, J. C. (1963) Khalkha Structure, Indiana University, Bloomington, Indiana.
- Strong, W. M. (1913-1914) "The Rora and Mekeo Languages of British New Guinea," Zeitschrift für Kolonialsprachen 4, 286.
- Trager, G. L., and H. L. Smith (1951) An Outline of English Structure, American Council of Learned Societies, Washington.
- Tryon, D. T. (1970) An Introduction to Maranungku, Pacific Linguistics Monographs, Series B, No. 14, Australian National University, Canberra.
- Tyler, S. A. (1969) Koya: An Outline Grammar, University of California Publications in Linguistics, No. 54, University of California Press, Berkeley and Los Angeles.
- van der Tuuk (1971) A Grammar of Toba Batak, Martinus Nijhoff, The Hague.
- Vergnaud, J.-R. (1977) "Formal Properties of Phonological Rules," in R. Butts and J. Hintikka, eds., Basic Problems in Methodology and Linguistics, D. Reidel, Dordrecht,
- Vergnaud, J.-R., and M. Halle (1978) "Metrical Structures in Phonology," unpublished manuscript, MIT, Cambridge, Mass.
- Worsley, A. (1925) Sudanese Grammar, Society for Promoting Christian Knowledge, London.
- Walker, J. (1791) A Critical Pronouncing Dictionary, reproduced by Scholar Press, Menston, England.

Biographical Note

The author was born June 9, 1955, in Seattle, Washington, the son of Donald and Florence Hayes. He attended public schools in Ithaca, New York, and received a B.A. cum laude in Linguistics and Applied Mathematics from Harvard College in 1976. While at MIT he held an NSF Graduate Fellowship and a teaching assistantship. He has accepted a position in the Department of Linguistics at Yale University. He enjoys playing the piano and listening to lieder, and is a closet Cornell hockey fan. His publications are:

- (1976) "The Semantic Nature of the Intervention Constraint," Linguistic Inquiry 7, 371-376.
- (1976) "Prepositional Phrase Extraposition," in J. Hankamer and Judith Aissen, eds., Harvard Studies in Syntax and Semantics, Vol. 2, pp. 222-241.
- (1979) "Extrametricity," in K. Safir, ed., MIT Working Papers in Linguistics, Vol. 1, pp. 77-87.
- (1979) "Ternary Stress Feet in English," in K. Safir, ed., MIT Working Papers in Linguistics, Vol. 1, pp. 88-94.
- (forthcoming) "Akran Stress: Disjunctive Ordering or Metrical Feet?" to appear in the Proceedings of the Eleventh Annual Meeting of the Northeastern Linguistic Society, University of Ottawa.

(forthcoming) "The Rhythmic Structure of Persian Verse," to appear in Edebiyat.