

ENERGY LABORATORY

MASSACHUSETTS INSTITUTE  
OF TECHNOLOGY

THE FUEL CYCLE ECONOMICS OF IMPROVED URANIUM  
UTILIZATION IN LIGHT WATER REACTORS

by

Ali T. Abbaspour  
Michael J. Driscoll

DOE Contract No. EN-77-S-02-4570, Nuclear Engineering  
Department Report No. MITNE-224, Energy Laboratory  
Report. MIT-EL 79-001. January 1979.



COO-4570-9  
MITNE-224  
MIT-EL-79-001

THE FUEL CYCLE ECONOMICS OF IMPROVED URANIUM  
UTILIZATION IN LIGHT WATER REACTORS

by

Ali T. Abbaspour  
Michael J. Driscoll

DOE Contract No. EN-77-S-02-4570, Nuclear Engineering  
Department Report No. MITNE-224, Energy Laboratory  
Report. MIT-EL 79-001. January 1979.

THE FUEL CYCLE ECONOMICS OF IMPROVED URANIUM UTILIZATION  
IN LIGHT WATER REACTORS

by

Ali T. Abbaspour  
Michael J. Driscoll

Department of Nuclear Engineering  
and  
Energy Laboratory  
MASSACHUSETTS INSTITUTE OF TECHNOLOGY  
Cambridge, Massachusetts 02139

Sponsored by

U.S. Department of Energy

NOTICE

This report was prepared as an account of work sponsored by the United States Government. Neither the United States nor the United States Department of Energy, nor any of their employees, nor any of their contractors, subcontractors, or their employees, makes any warranty, express or implied, or assumes any legal liability or responsibility for the accuracy, completeness or usefulness of any information, apparatus, product or process disclosed, or represents that its use would not infringe privately owned rights.

Printed in the United States of America

Available from

National Technical Information Service  
U.S. Department of Commerce  
5285 Port Royal Road  
Springfield, VA 22161

Price: Printed Copy, \$10.75; Microfiche, \$3.00.

DISTRIBUTION

NASAP Control Office  
U.S. Department of Energy  
Room F-409, Mail Stop B-107  
Germantown, Maryland 20767  
(3 copies c/o Howard Rohm)

C.E. Till  
Director, Applied Physics  
Argonne National Laboratory  
9700 South Cass Avenue  
Argonne, Illinois 60439

N.L. Shapiro  
Manager, Advanced Design  
Projects  
Combustion Engineering, Inc.  
1000 Prospect Hill Road  
Windsor, Connecticut 06095

M.C.J. Carlson  
Manager, Alternate Fuel Development  
Hanford Engineering Development Lab  
P.O. Box 1970  
Richland, Washington 99352

J.F. Jessick  
Project Manager  
Combustion Engineering, Inc.  
1000 Prospect Hill Road  
Windsor, Connecticut 06095

A. Gietzen  
Manager, TRIGA Reactor Development  
General Atomic Company  
P.O. Box 81608  
San Diego, California 92138

R.A. Matzie  
Project Manager  
Combustion Engineering, Inc.  
1000 Prospect Hill Road  
Windsor, Connecticut 06095

K.D. Kirby  
Project Manager  
Southern Science Applications,  
Inc.  
P.O. Box 10  
Dunedin, Florida 33528

D.E. Bartine  
Project Manager  
Oak Ridge National Laboratory  
P.O. Box X  
Oak Ridge, Tennessee 37830

J.R. Engel  
Project Manager  
Oak Ridge National Laboratory  
P.O. Box Y  
Oak Ridge, Tennessee 37830

R. Crowther  
Project Manager  
General Electric Company  
175 Curtner Avenue  
San Jose, California 95125

M. Steinberg  
Associated Universities, Inc.  
Brookhaven National Laboratory  
Upton, New York 11973

E. Straker  
Project Manager  
Science Applications, Inc.  
8400 Westpark Drive  
McLean, Virginia 22101

F.L. Ribe  
Principal Investigator  
University of Washington  
College of Engineering  
Department of Nuclear Eng'ring  
Seattle, Washington 98195

R.P. Omberg  
Manager, Advanced Concepts  
Hanford Engineering Development Lab  
P.O. Box 1970  
Richland, Washington 99352

S. Zwickler  
Project Engineer  
Burns and Roe  
P.O. Box 663  
Route 17, South  
Paramus, New Jersey 07652

S.M. Stoller  
President  
S.M. Stoller Corporation  
1250 Broadway  
New York, New York 10001

W.C. Lipinski  
Project Manager  
Argonne National Laboratory  
9700 South Cass Avenue  
Argonne, Illinois 60439

W.R. Harris  
Project Manager  
RAND Corporation  
1700 Main Street  
Santa Monica, California 90406

T.H. Row  
Oak Ridge National Laboratory  
P.O. Box X  
Oak Ridge, Tennessee 37830

B.A. Pasternak  
Research Director  
Booz-Allen and Hamilton  
4330 East-West Highway  
Bethesda, Maryland 20014

A. Weitzberg  
Principal Investigator  
Science Applications, Inc.  
8400 Westpark Drive  
McLean, Virginia 22101

M. Higgins  
Vice President for Energy  
and Environment  
Science Applications, Inc.  
8400 Westpark Drive  
McLean, Virginia 22101

I. Spiewak  
Project Manager, Nuclear  
Energy Assessments  
Oak Ridge National Laboratory  
P.O. Box Y, Bldg. 9201-3  
Oak Ridge, Tennessee 37830

V. Uotinen  
Project Manager  
The Babcock and Wilcox Co.  
P.O. Box 1260  
Lynchburg, Virginia 24505

C. Sege  
U.S. Department of Energy  
Room F-403, Mail Stop B-107  
Germantown, Maryland 20767

Peter M. Lang, Assistant Director  
LWR Development Branch  
Mail Stop G-434  
U.S. Department of Energy  
Washington, D.C. 20545

S. Strauch  
Acting Deputy Director  
Fuel Cycle Evaluation  
U.S. Department of Energy  
Room F-416, Mail Stop B-107  
Germantown, Maryland 20767

B. Feldman  
Chief, Reactor and Safeguards  
Branch  
Office of Classification  
U.S. Department of Energy  
Room A-23204, Mail Stop A-23220  
Germantown, Maryland 20545

Mr. John F. Foran  
Resource Planning Associates, Inc.  
44 Brattle Street  
Cambridge, Massachusetts 02138

Dr. Bal Raj Sehgal  
Nuclear Safety & Analysis Department  
Electric Power Research  
Institute  
3412 Hillview Avenue  
P.O. Box 10412  
Palo Alto, California 94304

Dr. A. Radkowsky  
Tel-Aviv University  
School of Engineering  
Ramat-Aviv, Tel Aviv 69970  
ISRAEL

Mr. C.M. Newstead  
Brookhaven National Laboratory  
Technical Support Organization  
Building 197  
Upton, New York 11973

B. Feldman  
Office of Classification  
U.S. Department of Energy  
Washington, D.C. 20545  
(2 copies)

Prof. M.C. Edlund  
Department of Mechanical Engineering  
Virginia Polytechnic Institute  
Blacksburg, Virginia 24061

Dr. W.H. McVey, Chief  
Technology Branch  
Division of Nuclear Power Development  
U.S. DOE  
Washington, D.C. 20545

John Cleveland  
Oak Ridge National Laboratory  
P.O. Box Y, Bldg. 9201-3  
Oak Ridge, Tennessee 37830

W.F. Witzig  
Nuclear Engineering Dept.  
Penn State University  
231 Sackett Bldg.  
University Park, PA 16802

Mr. Herbert Feinroth  
Special Assistant  
Division of Nuclear Power  
Development  
U.S. Department of Energy  
Mail Station B-107  
Washington, D.C. 20545

K.A. Trickett  
Senior Technical Assistant  
Division of Nuclear Power  
Development  
U.S. Department of Energy  
Mail Station B-107  
Washington, D.C. 20545

T. Robbins  
Pickard, Lowe & Garrick  
Suite 612  
1200 18th St. N.W.  
Washington, D.C. 20036

FINAL REPORTS ONLY

R. Braitsch  
Prog. Anal. for ETP  
US Department of Energy  
Room 7117  
Casimir Pulaski Bldg.  
20 Mass. Ave. NW  
Washington, DC 20545

T. Abernathy  
Chief, Documents Management Branch  
Technical Information Center  
U.S. Department of Energy  
P.O. Box 62  
Oak Ridge, TN 37830

(2 copies)

P. Afansenko  
Int. Adv. to Asst. Secy. for ET  
U.S. Department of Energy  
Room A-220, Mail Stop A-229  
Casimir Pulaski Bldg.  
20 Mass. Ave. NW  
Washington, DC, 20545



THE FUEL CYCLE ECONOMICS OF IMPROVED URANIUM UTILIZATION  
IN LIGHT WATER REACTORS

ABSTRACT

A simple fuel cycle cost model has been formulated, tested satisfactorily (within better than 3% for a wide range of cases) using a more elaborate computer program, and applied to evaluate a variety of PWR fuel cycles and fuel management options, with an emphasis on issues pertinent to the NASAP/INFCE efforts. The uranium and thorium cycles were examined, lattice fuel-to-moderator and burnup were varied, and once-through and recycle modes were examined.

It was found that increasing core burnup was economically advantageous, particularly if busbar or total system cost is considered in lieu of fuel cycle cost only, for both once-through and recycle modes, so long as the number of staggered core batches is increased concurrently. When optimized under comparable ground rules, the once-through fuel cycle is competitive with the recycle option; differences are well within the rather large ( $\pm 20\%$ ) one sigma uncertainty estimated for the overall fuel cycle costs by propagating uncertainties in input data. Optimization on mills/kwhre and ore usage, tones/GWe,yr, are generally, but not universally, compatible criteria.

To the extent evaluated, the thorium fuel cycle was not found to be economically competitive. Cost-optimum thorium lattices were found to be drier than for current PWRs, while cost-optimum uranium lattices are essentially those in use today. The cost margin of zircaloy over stainless steel decreases as lattice pitch is decreased, to the point where steel clad could be useful in very dry cores where its superior properties might be advantageous.

Increasing the scarcity-related escalation rate of ore price, or the absolute cost of ore, does not alter any of the major conclusions although the prospects for thorium and recycle cores improve somewhat.

### ACKNOWLEDGEMENTS

The work presented in this report has been performed primarily by the principal author, Ali Abbaspour, who has submitted substantially the same report in partial fulfillment of the requirements for the Nuclear Engineer degree at M.I.T.

The present work was supported by a Department of Energy (DOE) contract administered through the M.I.T. Energy Laboratory. Computer calculations were carried out at the M.I.T. Information Processing Center and the Laboratory for Nuclear Science.

The principal author would like to thank Francisco Correa for the information gained from many technical discussions.

Typing of this manuscript was ably handled by Ms. Cindi Mitaras.

## TABLE OF CONTENTS

	Page
TITLE PAGE	1
ABSTRACT	2
ACKNOWLEDGEMENTS	3
LIST OF TABLES	8
LIST OF FIGURES	11
 CHAPTER 1 INTRODUCTION	 14
1.1 Foreword	14
1.2 Background	15
1.3 Purpose and Outline of the Present Work	17
CHAPTER 2 A SIMPLE MODEL FOR FUEL CYCLE COST CALCULATION	20
2.1 Introduction	20
2.2 Derivation of Simple Model	21
2.2.1 Fuel Cost as a Depreciable Investment	21
2.2.2 Fuel Cost as an Expensed Cost	36
2.3 Computer Codes for Fuel Cycle Cost	38
2.3.1 MITCOST-II	38
2.3.2 GEM	39
2.3.3 A Comparison of MITCOST with GEM	40
2.4 Comparison of Simple Model with MITCOST-II	42
2.4.1 Base Case Study	42
2.4.2 Parametric Variations and Sensitivity Analysis	47
2.5 Analysis of Approximations	51
2.5.1 Effect of Startup Batches	51
2.5.2 Effect of Shutdown Batches	57
2.5.3 Effect of Using a Single Cash Flow for Revenue and Depreciation	59
2.6 Summary and Conclusions	62

	Page
CHAPTER 3 ECONOMIC ANALYSIS OF COUPLED FUEL CYCLES	65
3.1 Introduction	65
3.2 Reactor Systems Analyzed	65
3.3 Optimization of Fuel Cycle Cost	72
3.3.1 Effect of Fuel-to-Moderator Volume Ratio	72
3.3.2 The Indifference Value of Fissile Material	72
3.3.3 $^{235}\text{U}/^{238}\text{U}$ Coupled with $\text{Pu}/^{238}\text{U}$	76
3.3.4 $^{235}\text{U}$ (93%)/ $^{232}\text{Th}$ Reactors Coupled with $^{233}\text{U}/^{232}\text{Th}$ Reactors (Segregated Case)	84
3.3.5 The Once-Through Fuel Cycle	92
3.4 Effect of Ore Scarcity on the Economics of Coupled Fuel Cycles	96
3.4.1 Nature of the Problem	96
3.5 Comparative Analysis of Coupled Fuel Cycles	108
3.6 The Unit Price of Fissile Material	116
3.7 $^{235}\text{U}/^{232}\text{Th}$ Units Coupled with $^{233}\text{U}/^{232}\text{Th}$ Units (non segregated)	124
3.8 Summary and Conclusions	127
CHAPTER 4 ECONOMIC ANALYSIS OF PWR CORE DESIGN AND FUEL MANAGEMENT	132
4.1 Introduction	132
4.2 Allowing for the Presence of $^{236}\text{U}$ in Discharged Fuel	133
4.2.1 A Blending Method	133
4.2.2 Re-enrichment	143
4.3 Effect of Burnup of Fuel Cycle Cost	149
4.3.1 Once-through Fuel Cycle	149
4.3.2 Uranium Cycle with Uranium and Plutonium Recycle	158
4.3.3 Analysis of Approximations	163
4.4 Effect of Ore Escalation Rate on Optimum Discharged Burnup	164

	Page
4.5 Effect of Other Options on the Optimum Discharged Burnup	167
4.5.1 Short Refueling Downtime	167
4.5.2 Effect of Discharged Burnup on the Busbar Cost	169
4.5.3 Consideration of Replacement Cost	172
4.6 Effect of Different Ways of Treating Nuclear Fuel Transactions	174
4.6.1 Expensed Fuel Costs	174
4.6.2 Front-end Depreciated and the Back-end Cost Expended	176
4.7 Economic Analysis of Cladding Effects	176
4.7.1 Breakeven Cost of Low-Absorption Clad	176
4.7.2 Effect of $V_f/V_m$ on the Comparative Analysis of Zircaloy and Stainless Steel	180
4.7.3 Effect of Discharged Burnup on the Comparative Analysis of Zircaloy and Stainless Steel Clad	183
4.8 Summary and Conclusions	187
4.8.1 Summary	187
4.8.2 Conclusions	188
 CHAPTER 5 SUMMARY, CONCLUSIONS AND RECOMMENDATIONS	 191
5.1 Introduction	191
5.2 Summary and Conclusions	192
5.3 Recommendations for Further Work	206
 APPENDIX A DERIVATION OF PSEUDO-CASH-FLOW FORMULATION	 208
APPENDIX B SIMMOD PROGRAM	211
APPENDIX C MODIFICATION OF MITCOST-II	219
APPENDIX D MASS FLOWS CHARGED AND DISCHARGED	222
APPENDIX E CALCULATION OF TRANSACTION QUANTITIES	232
E.1 Once-Through Cycle	232
E.2 <sup>235</sup> U/U Cycle with Uranium and Plutonium Recycle	233

	Page
E.3 $^{235}\text{U}/\text{Th}$ Cycle	242
E.4 $^{233}\text{U}/\text{Th}$ and Pu/U Cycle	244
E.5 Tables of Transaction Quantities	244
APPENDIX F TREATMENT OF INFLATION	245
REFERENCES	258

## LIST OF TABLES

	Page	
2-1	A NUMERICAL COMPARISON OF RESULTS BETWEEN THE ORIGINAL AND MODIFIED VERSIONS OF GEM AND MITCOST	41
2-2	CHARACTERISTICS OF A REPRESENTATIVE PWR	43
2-3	CHARACTERISTICS OF CORE START-UP BATCHES	44
2-4	BASE CASE FUEL CYCLE TRANSACTIONS	45
2-5	COMPARISON OF MITCOST AND SIMPLE MODEL FOR SEVERAL PARAMETRIC VARIATIONS	49
2-6	EVALUATION OF THE EFFECT OF ORE ESCALATION RATE	50
2-7	CHARACTERISTICS OF 250 MWth, BATCH-LOADED PWR	55
2-8	TRANSACTION QUANTITIES FOR BATCH LOADED PWR	56
2-9	THE OVERALL LEVELIZED FUEL CYCLE COST FOR THE BASE CASE	64
3-1	MAINE YANKEE CORE PARAMETERS	67
3-2	UNIT PRICES AND ECONOMIC DATA FOR COUPLED FUEL CYCLES	77
3-3	OVERALL LEVELIZED FUEL CYCLE COST OF $^{235}\text{U}/^{238}\text{U}$ UNITS COUPLED WITH $\text{Pu}/^{238}\text{U}$ UNITS	80
3-4	OVERALL LEVELIZED FUEL CYCLE COST OF $^{235}\text{U}(93\%)/^{232}\text{Th}$ REACTORS COUPLED WITH $^{233}\text{U}/^{232}\text{Th}$ REACTORS	88
3-5	ORE AND SWU REQUIREMENTS FOR THE $^{235}\text{U}(93\%)/^{232}\text{Th}$ CYCLE	90
3-6	ORE USAGE AND FUEL CYCLE COST FOR THE ONCE-THROUGH FUEL CYCLE	95
3-7	TIME-ZERO COST OF ORE FOR DIFFERENT SCENARIOS	106
3-8	VALUES OF $\alpha$ , $\beta$ , $\tau$ FOR $\text{Pu}$ AND $^{233}\text{U}$	123
4-1	UNIT COST OF DIFFERENT STEPS IN THE FUEL CYCLE	151
4-2	FUEL MANAGEMENT DATA FOR 3 BATCH CORE, ONCE-THROUGH MODE	153
4-3	FUEL MANAGEMENT DATA FOR A SIX BATCH CORE ON THE ONCE-THROUGH FUEL CYCLE	155
4-4	THE BREAKEVEN INCREASED COST OF LOW-ABSORPTION ZIRCALOY	179

5-1	COMPARISON OF MITCOST AND SIMPLE MODEL FOR SEVERAL PARAMETRIC VARIATIONS	195
5-2	OVERALL LEVELIZED FUEL CYCLE COST OF $^{235}\text{U}(93\%)/^{232}\text{Th}$ REACTORS COUPLED WITH $^{233}\text{U}/^{232}\text{Th}$ REACTORS	197
5-3	OVERALL LEVELIZED FUEL CYCLE COST OF $^{235}\text{U}/^{238}\text{U}$ UNITS COUPLED WITH $\text{Pu}/^{238}\text{U}$ UNITS	198
5-4	ORE USAGE AND FUEL CYCLE COST FOR THE ONCE-THROUGH FUEL CYCLE	199
5-5	FUEL CYCLE COST AND ANNUAL ORE USAGE FOR THE THREE BATCH CORE	201
5-6	FUEL CYCLE COST AND ANNUAL ORE USAGE FOR THE SIX BATCH CORE	202
5-7	FUEL CYCLE COST, BUSBAR COST AND TOTAL SYSTEM COST FOR THE THREE BATCH CORE ON THE ONCE-THROUGH FUEL CYCLE	204
D-1	CHARGE AND DISCHARGE MASSES FOR THE $\text{UO}_2$ (SLIGHTLY ENRICHED U-235) REACTOR	223
D-2	CHARGE AND DISCHARGE MASSES FOR THE $\text{PuO}_2/\text{UO}_2$ REACTOR	224
D-3	CHARGE AND DISCHARGE MASSES FOR THE $\text{UO}_2$ (93% ENRICHED U-235)/ $\text{ThO}_2$ REACTOR	225
D-4	CHARGE AND DISCHARGED MASSES FOR THE $^{233}\text{UO}_2/\text{ThO}_2$ REACTOR (SEGREGATED)	226
D-5	CHARGED AND DISCHARGED MASSES FOR THE TIGHT-LATTICE PITCH $^{233}\text{U}/\text{Th}$ UNITS (SEGREGATED)	227
D-6	MASS FLOWS CHARGED AND DISCHARGED FOR 3 BATCH CORE, ZIRCALOY CLAD, $V_f/V_m = 0.513$	228
D-7	MASS FLOWS CHARGED AND DISCHARGED FOR THE 6 BATCH CORE ZIRCALOY CLAD $V_f/V_m = 0.513$	229
D-8	MASS FLOWS CHARGED AND DISCHARGED FOR THE 3 BATCH CORE $^{233}\text{U}/\text{Th}$ CYCLE, ZIRCALOY AND STAINLESS STEEL CLAD	230
D-9	MASS FLOWS CHARGED AND DISCHARGED FOR 3 BATCH CORE STAINLESS CLAD (18 mils) ( $V_f/V_m = 0.513$ )	231



		Page
E-1	TRANSACTION QUANTITIES $^{235}\text{U}/\text{U}$ UNIT, 3 BATCH CORE	246
E-2	TRANSACTION QUANTITIES FOR $\text{Pu}/\text{U}$ UNITS, 3 BATCH CORE	247
E-3	TRANSACTION QUANTITIES FOR $^{235}\text{U}(93\%)/\text{Th}$ , 3 BATCH CORE	248
E-4	TRANSACTION QUANTITIES FOR $^{233}\text{U}/\text{Th}$ UNITS, THREE BATCH CORE	249
E-5	TRANSACTION QUANTITIES FOR $^{233}\text{U}/\text{Th}$ UNITS, 3 BATCH CORE (tight lattice pitch)	250
E-6	TRANSACTION QUANTITIES FOR $^{235}\text{U}/\text{U}$ CYCLE 3 BATCH-ZIRCALOY CLAD	251
E-7	TRANSACTIONS QUANTITIES OF THE 6 BATCH CORE, ZIRCALOY CLAD	252
E-8	TRANSACTION QUANTITIES OF THE THREE BATCH REACTOR	253
E-9	TRANSACTION QUANTITIES FOR THREE BATCH AND STAINLESS STEEL CLAD (ONCE THROUGH MODE)	254

## LIST OF FIGURES

	Page
1.1 Schematic Diagram of the LWR Nuclear Fuel Cycle	16
2.1 Nuclear Cash Flow Diagram for a Batch of Fuel	22
2.2 Cash Flow Diagram Considered for Simple Model	24
2.3 Sequence of Equilibrium Batches for a 3 Batch Core	25
2.4 Variation of Overall Levelized Fuel Cycle Cost with Ore Cost	48
3.1 $^{235}\text{U}/\text{Th}$ Units Coupled with $^{233}\text{U}/\text{Th}$ Unit for a. Non-Segregated and b. Segregated Cases	68
3.2 A $^{235}\text{U}/^{238}\text{U}$ Cycle Coupled with the $^{239}\text{Pu}/^{232}\text{Th}$ Cycle to Produce $^{233}\text{U}$ for a $^{233}\text{U}/^{232}\text{Th}$ Cycle	70
3.3 A $^{235}\text{U}/^{238}\text{U}$ Cycle Coupled with the $^{239}\text{Pu}/^{238}\text{U}$ Cycle	71
3.4 Power Cost of Producer and Consumer Reactors as a Function of the Unit Price of Fissile Material	75
3.5 Overall Levelized Fuel Cycle Cost versus Unit Price of Fissile Plutonium for $^{235}\text{U}/^{238}\text{U}$ and $\text{Pu}/^{238}\text{U}$ Cycles	81
3.6 Overall Levelized Fuel Cycle Cost and Ore Requirement as a Function of Fuel to Moderator Volume Ratio for Coupled $^{235}\text{U}/^{238}\text{U}$ and $\text{Pu}/^{238}\text{U}$ Cycles	82
3.7 Overall Levelized Fuel Cycle Cost of $^{235}\text{U}/^{232}\text{Th}$ and $^{233}\text{U}/^{232}\text{Th}$ Fueled Reactors as a Function of the Unit Price of $^{233}\text{U}$	86
3.8 The Overall Levelized Fuel Cycle Cost and Ore Requirement as a Function of $V_f/V_m$ for Coupled $^{235}\text{U}/\text{Th}$ (segregated) and $^{233}\text{U}/\text{Th}$ Cycles	87
3.9 Overall Levelized Fuel Cycle Cost of $^{235}\text{U}/^{232}\text{Th}$ Units Coupled with $^{233}\text{U}/^{232}\text{Th}$ Units versus Fuel to Moderator Volume Ratio of the Consumer Reactor (extended scale)	93
3.10 Fuel Cycle Cost and Ore Usage versus $V_f/V_m$ for the Once-Through Fuel Cycle	94
3.11a Overall Levelized Lifetime Fuel Cycle Cost of $^{235}\text{U}/\text{U}$ units Coupled with $\text{Pu}/\text{U}$ units versus $V_f/V_m$ for 0%, 6% and 10%/yr Ore Price Escalation Rate	98
3.11b Overall Levelized Fuel Cycle Cost of $^{235}\text{U}/\text{Th}$ Units Coupled with $^{233}\text{U}/\text{Th}$ Units versus $V_f/V_m$ for 0%, 6% and 10% yr Ore Price Escalation Rates	99

	Page
3.12 Schematic Representation of Ore Price Escalation Scenarios	105
3.13 Fuel Cycle Cost of $^{235}\text{U}/\text{U}:\text{Pu}/\text{U}$ System and $^{235}\text{U}/\text{Th}:\text{}^{233}\text{U}/\text{Th}$ Systems versus $V_f/V_m$ for Different Time Zero Cost of Ore and 0% Escalation Rate	107
3.14a Overall Levelized Fuel Cycle Cost versus $V_f/V_m$ for $^{235}\text{U}/\text{U}:\text{Pu}/\text{U}$ and $^{235}\text{U}/\text{Th}:\text{}^{233}\text{U}/\text{Th}$ Systems (30 Steady State Batches)	109
3.14b Overall Levelized Fuel Cycle Cost versus $V_f/V_m$ for $^{238}\text{U}/\text{U}:\text{Pu}/\text{U}$ and $^{235}\text{U}/\text{Th}:\text{}^{233}\text{U}/\text{Th}$ Systems (Reactor Lifetime 30 years)	111
3.15 Fuel Cycle Cost as a Function of Ore Escalation Rate (Time Zero-Cost of Ore is the Same for all Cases)	112
3.16a Fuel Cycle Cost as a Function of Fissile Price for Low $V_f/V_m$	115
3.16b Fuel Cycle as a Function of Fissile Price for High $V_f/V_m$	115
3.17 Variation of $\alpha$ with Escalation Rate	121
3.18 Fuel Cycle Cost of the $^{235}\text{U}/\text{Th}:\text{}^{233}\text{U}/\text{Th}$ System (non-segregated) versus Fuel-to-Moderator Volume Ratio	126
4.1 Recycling of Uranium Using the Blending Method	135
4.2 Variation of Net Credit for Discharged Fuel with the Weight per cent of $^{236}\text{U}$ in the Fuel Fed to the Reactor	141
4.3 Schematic Diagram of Re-enrichment Method	145
4.4 Overall Levelized Fuel Cycle Cost versus Burnup for Three and Six Batch Cores for Once-Through Operation	152
4.5 The Overall Levelized Fuel Cycle Cost and Ore Usage versus Burnup for the 3 and 6 Batch Cores	159
4.6 Fuel Cycle Cost versus Burnup for the Three and Six Batch Cores and the Once-Through Fuel Cycle	165
4.7 Fuel Cycle Cost versus Burnup for the Three and Six Batch Cores in the Recycling Mode	166
4.8 Fuel Cycle Cost versus Burnup for 3 and 6.5 week Refueling Downtime	168
4.9 Busbar Cost and Total System Cost as a Function of Discharged Burnup for the Three and Six Batch Cores	171
4.10 Fuel Cycle Cost versus Burnup, for Different Treatments of Nuclear Fuel	175

	Page	
4.11	Ratio between the Absorption of Neutrons in Stainless Steel and Zircaloy as a Function of $V_f/V_m$	181
4.12	Comparison of Zircaloy and Stainless Steel Clad	184
4.13	Fuel Cycle Cost and Ore Usage versus Burnup for Zircaloy and Stainless Steel Clad	186
5.1	The Overall Levelized Fuel Cycle Cost and Ore Usage versus Burnup for the 3 and 6 Batch Cores	205
C-1	The Fuel Cycle Cost per Batch where $f = 0.01$	220
C-2	The Fuel Cycle Cost per Batch when MITCOST-II has been Modified (to set $Z(15,3), Z(16,3)$ and $Z(17,3) \equiv 0$ )	221
E-1	$K_{eff}$ versus Burnup for Different Combinations of $^{235}\text{U}$ and $^{236}\text{U}$	238
E-2	$^{235}\text{U}$ Penalty in Fuel Charged to Reactor due to Presence of $^{236}\text{U}$	240

## CHAPTER 1

## INTRODUCTION

## 1.1 Foreword

The recent activation of the Nonproliferation Alternative System Assessment Program (NASAP) and International Nuclear Fuel Cycle Evaluation (INFCE) efforts to re-assess the status of prospects for the nuclear fuel cycle has highlighted the need for work in a number of areas. The associated subtasks funded by DOE at MIT are concerned with the system characterization of improved PWR core designs and fuel cycle performance. Work to date, published in two topical reports (G-1)(F-3), has focused on improving ore utilization. The present report analyzes the same designs and operational scenarios from the point of view of fuel cycle economics.

Although a major object of the present work has been to analyze a broad spectrum of options on a self-consistent basis, the primary emphasis has been on aspects of contemporary interest: the once-through LWR fuel cycle in particular. Similarly, while the thorium fuel cycle is also examined, the uranium fuel cycle is emphasized. Finally, consideration is concentrated on current-design PWR cores, and a limited number of improved versions (chiefly tight pitch) and fuel management schemes (mainly increased burnup and more core batches) on the basis that LWR's dominate the current nuclear economy and 2/3 of all LWRs world wide are PWRs; moreover BWRs are sufficiently similar that many of the conclusions will apply across the board. Breeder reactors have been excluded on the basis that they can not have a substantial impact on fuel utilization during the time span of interest here, and in specific recognition of current U.S. policy to forego reprocessing and breeder deployment for the foreseeable future.

## 1.2 Background

The term "fuel cycle" refers to all steps from the time when the fuel is purchased as yellowcake through enrichment, and fabrication (which comprise the so-called front-end) followed by irradiation and then the back -end steps: storage and/or disposal for the once-through mode, or reprocessing (and sale for re-use) for the recycling mode. Figure (1.1) shows the nuclear fuel cycle for LWRs. Each step, and transportation between steps, must be considered in determination of the fuel cycle contribution to the cost of electricity.

Among the steps in the nuclear fuel cycle the purchase of yellowcake ( $U_3O_8$ ) and the enrichment cost have the greatest effect on nuclear fuel cycle costs. For example, for a typical PWR, operating on the uranium cycle, the purchase cost of the ore accounts for on the order of 50% of the fuel cycle cost, and the enrichment cost is about 25% of the total. Thus 75% of the nuclear fuel cycle cost is attributable to these two components. Therefore, variation of the unit prices of ore and separative work will have a dominant effect on the fuel cycle cost, and hence on both the short and long-term strategy which will be selected for fuel management and fuel cycle development. However, the unit cost of separative work is not expected to change significantly in the future (being a manufacturing process, and in an area where rapid technological advances are being made), whereas the price of ore has already risen from 7 \$/lb in 1971 to 42 \$/lb in 1978 and as higher grade ore becomes scarcer, is projected to escalate steadily ad infinitum (G-2). Thus decreasing the annual ore usage of a PWR will in general also cause the fuel cycle cost to decrease significantly. Therefore initial work at MIT focused on ore utilization rather than fuel cycle cost.

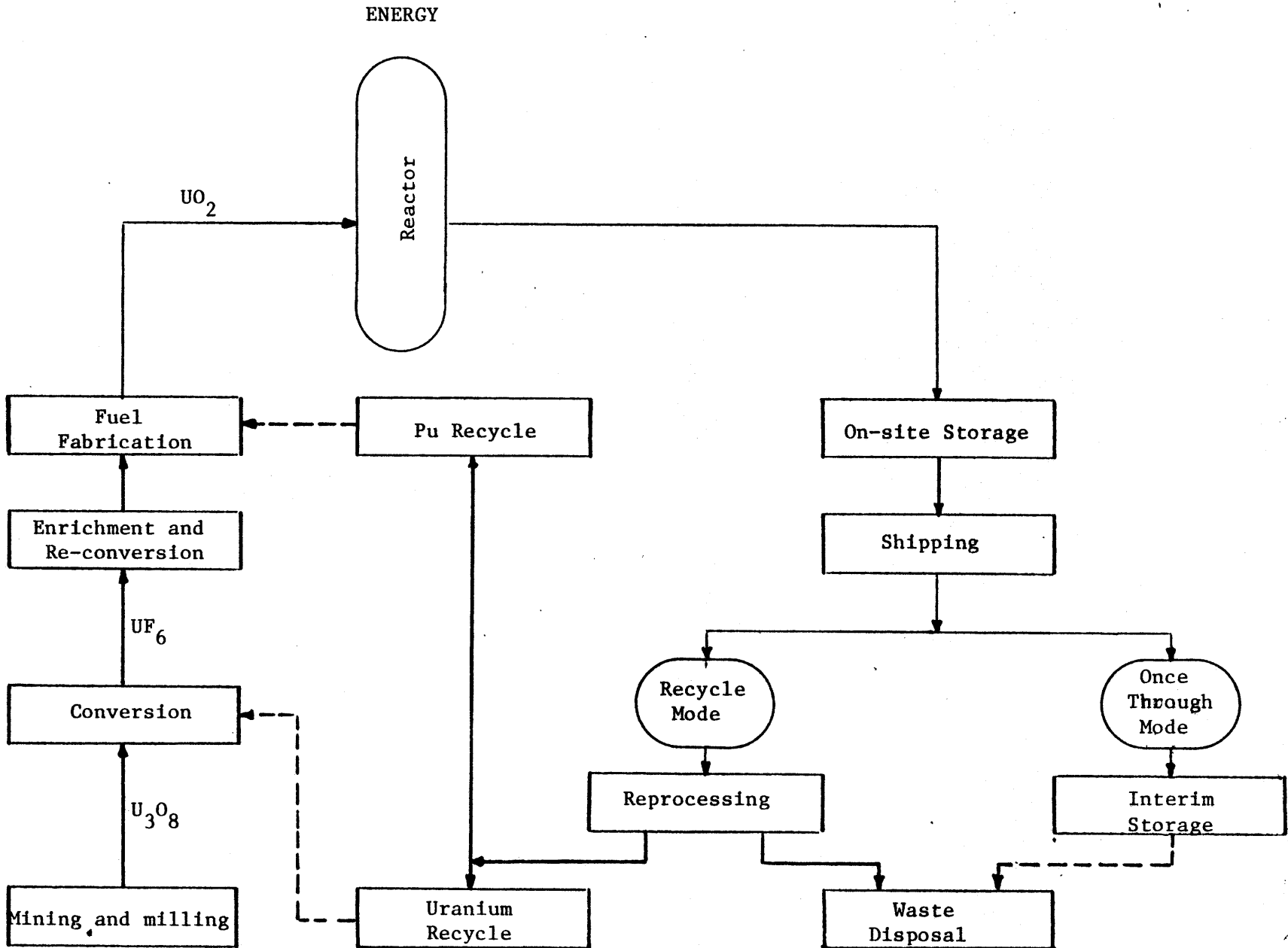

Figure 1.1 Schematic Diagram of the LWR Nuclear Fuel Cycle

Garel (G-1) has shown, for example, that on the once-through fuel cycle, the optimum PWR core has a fuel-to-moderator volume ratio close to that of present designs, and Fujita (F-3) subsequently confirmed that ore utilization was further improved by extending burnup and increasing the number of staggered core batches. Work is currently underway by Correa (C-2) on recycle mode optimization, considering both thorium and uranium fuel cycles. To properly interpret the results to date and to establish meaningful objectives for future work it is essential that the connection between ore consumption and mills/kwhre be carefully delineated, particularly where conventional economics may work to the disadvantage of ore saving in the short term. The work summarized in this report was undertaken to establish the nature of this functional transformation between optimization criteria: tons  $U_3O_8$ /GWe yr and mills/kwhre.

### 1.3 Purpose and Outline of the Present Work

A primary objective of the work reported here has been to analyze the effect of fuel-to-moderator volume ratio and discharged burnup on the fuel cycle cost of a representative PWR. Side-by-side comparisons of once-through and recycle modes have been of major interest. Comparative analysis of the uranium and thorium cycles has been a major parallel topic. To achieve these goals a simple economic model has been formulated. In keeping with these objectives, this report has been organized into three main chapters.

Chapter 2 deals with the derivation of a simple economic model to provide a tool for calculation of fuel cycle costs. As will be seen, the simplicity of this model provides sufficient flexibility to permit an analysis of the effect of all key parameters on the fuel cycle cost of a



wide variety of fuel cycle scenarios in a convenient (and inexpensive) manner. In this chapter the accuracy and precision of this model is examined against the considerably more elaborate state-of-the-art program MITCOST-II. The simplifying assumptions which constitute the ultimate limits on the accuracy of this model are also identified in this chapter.

In Chapter 3 the effect of fuel-to-moderator volume ratio on fuel cycle cost has been discussed. Two coupled systems, namely  $^{235}\text{U}/\text{U}:\text{Pu}/\text{U}$  and  $^{235}\text{U}(93\%)/\text{Th}:\text{^{233}U}/\text{Th}$  are studied and the once-through uranium fuel cycle is also considered to provide a basis for comparative analysis. Different ways of increasing ore price and their effect on the fuel cycle cost of each coupled cycle (and especially their intercomparison) are studied in this chapter. The indifference value of fissile material is determined, and correlations for the unit price of fissile plutonium and  $^{233}\text{U}$  as a function of ore price, separative work cost and escalation rate are developed. Finally, the relative advantages and disadvantages of these coupled cycles are discussed in this chapter.

The effect of discharged burnup on fuel cycle cost is investigated in Chapter 4. In this chapter we optimize the discharged burnup of the uranium cycle for both once-through and recycling modes. The effect of increasing the number of batches on the optimum discharged burnup is also studied, and discussed. The impact of ore escalation rate is also considered. It is shown that consideration of busbar and system costs of electricity increases the optimum burnup over that calculated using only fuel cycle costs. The relative economic merits of zircaloy and stainless steel clad are also studied in this chapter.

The report concludes with a summary, conclusions and recommendations in Chapter 5. Finally, several appendixes are included to summarize details which digress from the body of the text, to compile data of various types, and to document the SIMMOD program.

## CHAPTER 2

## A SIMPLE MODEL FOR FUEL CYCLE COST CALCULATION

## 2.1 Introduction

The objective of this chapter is to provide a simple tool for calculation of levelized fuel cycle cost. Although there are sophisticated computer codes for this purpose, such as GEM-III and MITCOST-II, a more explicit model capable of showing the effect of various parameters, such as discount rate, unit costs, escalation rates, etc., in a more transparent manner was felt to be highly desirable. As a result, a simple model, stripped to its essentials, but capable of precision adequate for planned applications, was developed. In addition to the advantage of being analytically compact, the computerized version of the simple model is much less expensive to run than the more elegant codes, which is preferable in work of the present type, where a large number of parametric studies are to be carried out.

The accuracy of the simple model has been checked against MITCOST-II over a wide range of all important variables, and their effect on the discrepancies of the simple model have been identified and discussed.

In the derivation of the simple model it should be noted that fuel expenses can be treated as a depreciable investment (as is customary in the United States today) or as an expensed cost similar in kind to that of other types of fuel such as coal or oil (a variation of interest here since we wish to ascertain the effect, if any, on fuel management strategy). Thus, in derivation of the simple model both approaches have been considered.

## 2.2 Derivation of Simple Model

### 2.2.1 Fuel Cost as a Depreciable Investment

In this section we will consider the fuel cost as a depreciable investment and find an expression for the levelized fuel cycle cost. The derivation of this "Simple Model" starts from the point where all expenditures (such as ore cost, fabrication cost, enrichment cost) are balanced against revenue from the sale of electricity produced by each batch of fuel during the life of a reactor. In the fuel recycling mode, post-irradiation credit for ore or separative work will be considered as negative expenses.

Consider the  $n^{\text{th}}$  batch of a reactor core consisting of a succession of  $N$  identical steady-state batches. Figure 2.1 shows the cash flow diagram for this batch.

In this figure

$C_i$  ( $i=1, m$ ) = Expenses or credits which occur for batch  $n$ , such as purchase of  $U_3O_8$ , fabrication cost, credit for Pu

$t_i$  ( $i=1, m$ ) = The time at which payment or credit for step  $i$  will occur for batch  $n$ , with respect to the start of irradiation of batch  $n$ ;  $t_i$  is negative if the cash flow is before the start of irradiation of batch  $n$ , and it is positive if it occurs after this reference time.

This figure shows a close approximation to the actual diagram, since revenue from the sale of electricity and the payment of taxes should be considered as explicit periodic cash flows. In the Simple Model

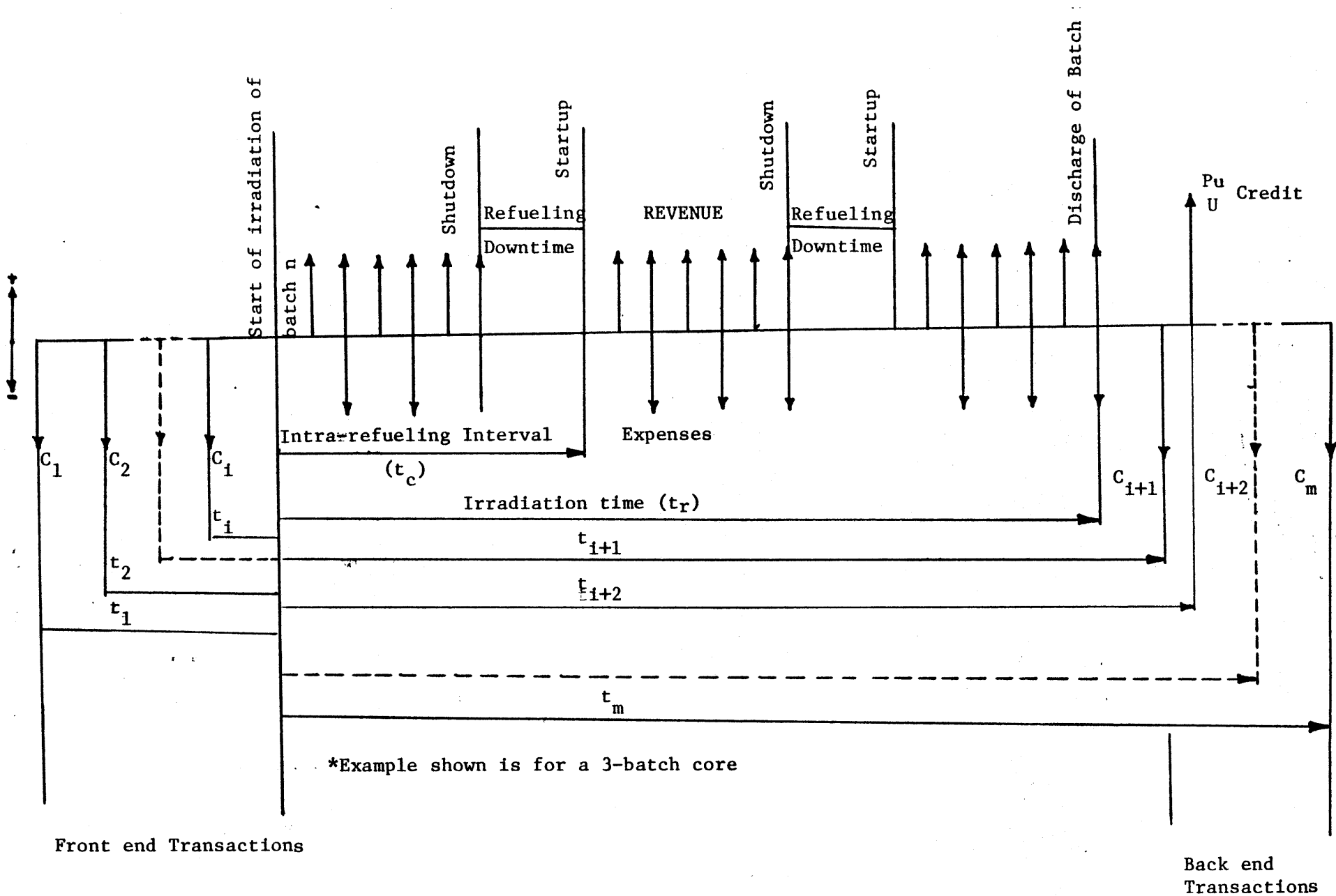

Figure 2.1 Nuclear Cash Flow Diagram for a Batch of Fuel

it is assumed that revenue and depreciation charges for each batch are represented by single payments at the middle of the irradiation interval. The effect of this assumption on the levelized fuel cycle cost will be discussed later.

Figure 2.2 shows the cash flow diagram which has been considered in derivation of the Simple Model. The origin of the time variable is assumed to be the starting time of the irradiation of the first batch, which coincides with the irradiation of the first equilibrium batch. Equilibrium batches are defined as those batches which have equal in-core residence times and equal charge and discharge enrichment. In actual practice,  $(m-1)$  batches of an  $m$ -batch initial core are "odd lot" batches required to start up the reactor, and only the  $m^{\text{th}}$  batch and reload batches are, for all practical purposes, equilibrium batches. The last  $(m-1)$  batches can also be non-equilibrium if the end of reactor life is properly anticipated. In derivation of the Simple Model only equilibrium batches are considered. Thus the starting time of irradiation of the first batch will always coincide with the irradiation of the first equilibrium batch. With this definition if, for example, we have a three-zone core and one year refueling intervals, batch number three and its successive batches (except for the final two batches) will each remain in the core for three years. Figure 2.3 illustrates the above discussion: note that batches have been renumbered 1, 2, ... n so that the batch index refers to position in the sequence of equilibrium batches. Thus, if  $t_c$  is defined as the intra-refueling interval (time between post-refueling startups), the start of irradiation of batch n occurs at  $(n-1)t_c$ , as shown in Figure 2.3.

It should be emphasized that in derivation of the Simple Model only equilibrium batches have been considered and the effects of the other startup

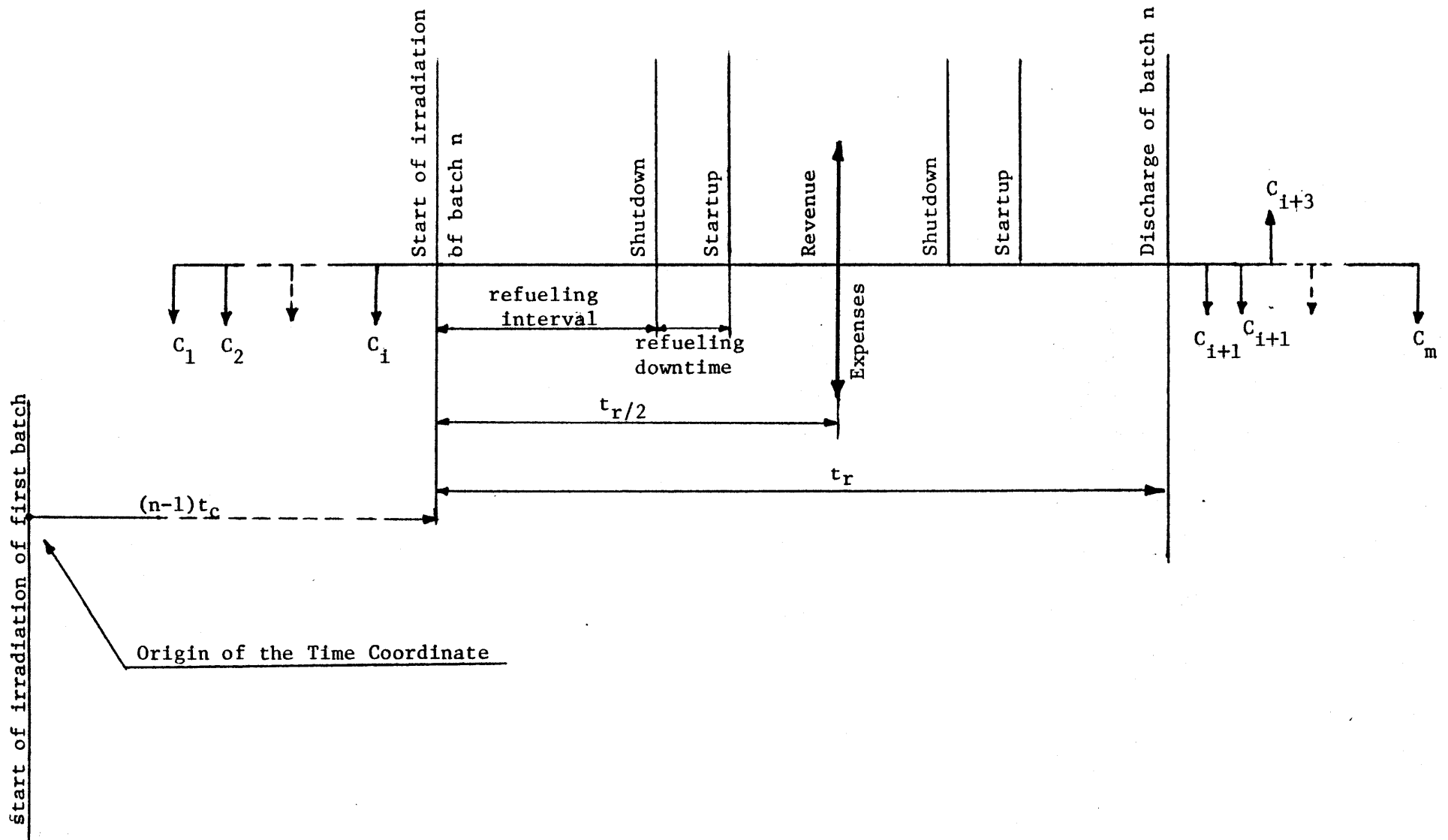

Figure 2.2 Cash Flow Diagram Considered for Simple Model

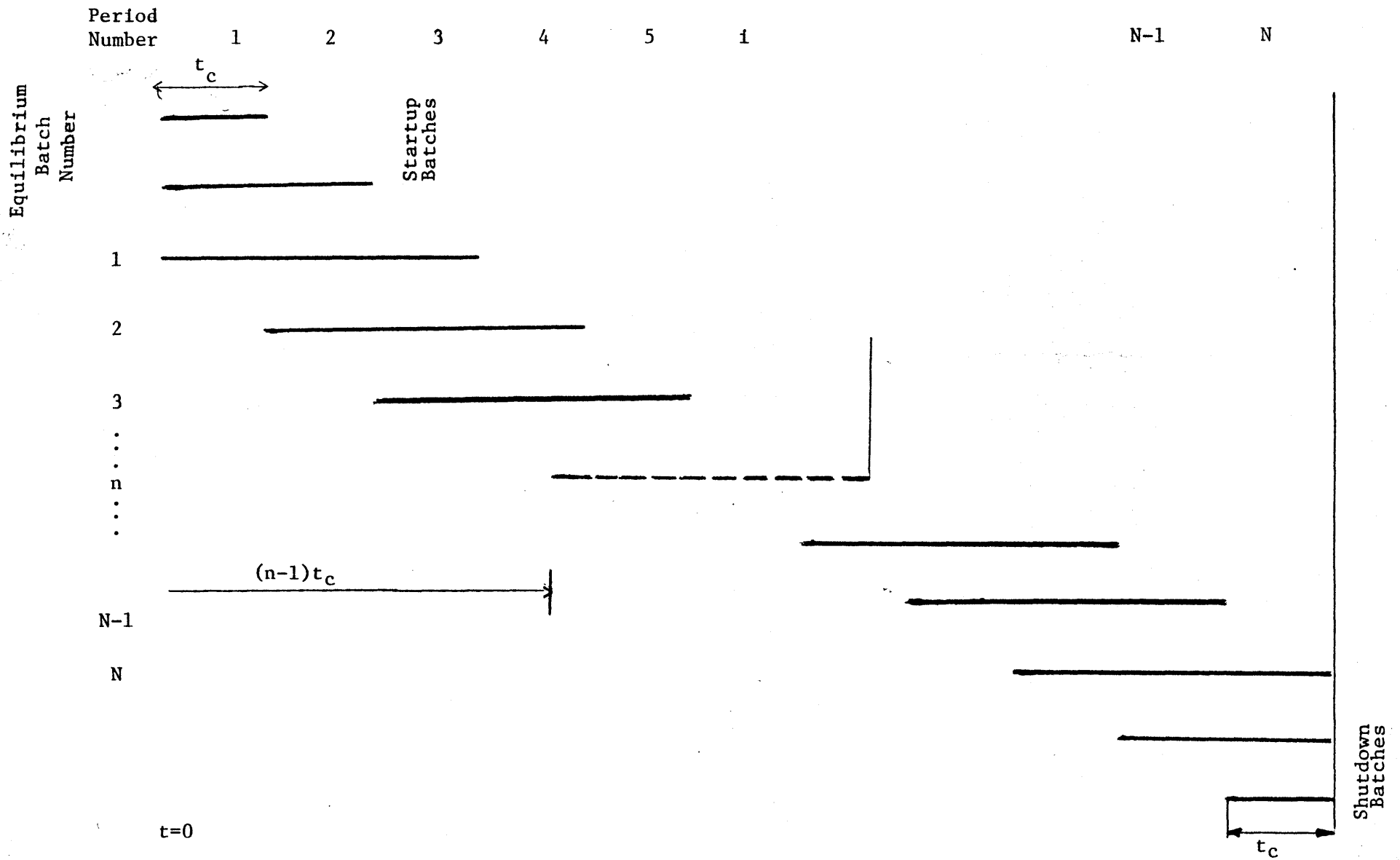

Figure 2.3 Sequence of Equilibrium Batches for a 3 Batch Core



batches (and shutdown batches) have been ignored. The effect of the final batches on the levelized fuel cycle cost are not important, since they occur a long time after the start of irradiation of the first batch and the present worth factors weighting these batches are small. Although the startup batches have a non-negligible effect on the levelized fuel cycle cost (and as will be discussed later, give rise to the single largest discrepancy in the simple model), the error is within acceptable limits.

With the above assumptions and conventions, the model can now be set up; According to the pseudo-cash-flow formulation of a present worth balance (see Appendix A).

$$I_n(P/F, x, n) = I_o - \sum_{j=1}^m \{(1 - \tau)F_j + \tau D_j\} (P/F, x, j) \quad (2.1)$$

where

$I_o$  = Initial investment

$x$  = Discount rate =  $(1 - \tau)f_b r_b + f_s r_s$

$\tau$  = Tax fraction

$f_b$  = Debt fraction

$f_s$  = Equity fraction =  $1 - f_b$

$r_b$  = Rate of return to bond holders

$r_s$  = rate of return to stock holders

$D_j$  = Depreciation

$F_j$  = Before-tax cash flow in year  $j$

$I_n$  = End of life salvage value

$m$  = number of period

$(P/F, x, t) \equiv (1 + x)^{-t} = 1/(F/P, x, t)$ , the present worth factor

(using standard nomenclature - see any recent text in engineering economics, for example Reference (D-1)).

In derivation of the Simple Model it is assumed that in-core fuel cycle operation and maintenance costs are equal to zero. On this basis

$$\sum_{j=1}^m F_j(P/F, x, j) = \frac{1}{1-\tau} I_0 - \frac{\tau}{1-\tau} \sum_{j=1}^m D_j(P/F, x, j) \quad (2.2)$$

Now consider batch n; the present worth of the initial investment,  $I'_0$ , with respect to the start of irradiation of batch n is

$$I'_0 = \sum_{i=1}^I M_i C_i^*(P/F, x, t_i) \quad (2.3)$$

where

$M_i$  = Transaction quantity involved in the  $i^{\text{th}}$  step  
(e.g. kg SWU or HM)

$C_i^*$  = Unit price (e.g. \$/Kg or \$/lb) of the  $i^{\text{th}}$  step  
(in then-current dollars)

$t_i$  = lag or lead time for step  $i$

$i = 1, 2, 3, \dots$  I.D. numbers of transactions

The summation is over all steps.

As mentioned before, the origin of the time coordinate (time-zero) is the start of irradiation of the first batch; and time  $(n-1)t_c$ , marks the start of irradiation of batch n. Thus, if  $C_i$  is the unit price of the  $i^{\text{th}}$  step at time zero (time zero dollars) and  $y_i$  is the escalation rate for this step, then

$$C_i^* = C_i [F/P, y_i, (n-1)t_c + t_i] \quad (2.4)$$

Therefore, the present worth of the initial investment,  $I_0$  for batch n, with respect to the origin of the time axis, and in terms of time-zero dollars, is

$$I_0 = \sum_{i=1}^I M_i C_i [F/P, y_i, (n-1)t_c + t_i] [P/F, x, (n-1)t_c + t_i] \quad (2.5)$$

It was mentioned that depreciation for each batch was assumed to take place in a single payment at the middle of the irradiation interval. Thus, the depreciation for batch n is equal to

$$\sum_{i=1}^I M_i C_i^*$$

and its present worth value with respect to time zero is

$$\left[ \sum_{i=1}^I M_i C_i^* \right] [P/F, x, (n-1)t_c + t_r/2]$$

where  $t_r$  is irradiation time. In terms of time-zero dollars we can write

$$\sum_j D_j = \sum_{i=1}^I M_i C_i [F/P, y_i, (n-1)t_c + t_i] [P/F, x, (n-1)t_c + t_r/2] \quad (2.6)$$

The levelized fuel cycle cost for batch n,  $e_n^*$ , is defined as that unit price in mills/kwhre, which if charged uniformly during the residence time of batch n in the core (Irradiation time) will provide revenues which will just pay for all charges. Thus if we assume batch n produces E kwhre electricity during its residence time in the core, then according to the definition of  $e_n^*$ , the revenue required from the sale of electricity is  $e_n^*E$ , which will be credited at the middle of the irradiation interval. Thus, the revenue for batch n in then-current dollars is

$$e_n^* E$$

and its present worth with respect to the origin of the time axis is

$$e_n^* E[P/F, x, (n-1)t_c + t_{r/2}]$$

In terms of time-zero dollars we have

$$\sum_j F_j = e_n^* E[P/F, x, (n-1)t_c + t_{r/2}][F/P, y_e, (n-1)t_c + t_{r/2}] \quad (2.7)$$

where  $y_e$  is the escalation rate for the price of electricity (as allowed for example, by the cognizant regulatory body).

If Equations (2.5), (2.6) and (2.7) are substituted into Equation (2.2), one obtains for batch  $n$ :

$$\begin{aligned} & 1000 e_n^* E[F/P, y_e, (n-1)t_c + t_{r/2}][P/F, x, (n-1)t_c + t_{r/2}] \\ &= \frac{1}{1-\tau} \sum_{i=1}^I M_i C_i [F/P, y_i, (n-1)t_c + t_i][P/F, x, (n-1)t_c + t_i] \\ & \quad - \frac{1}{1-\tau} \sum_{i=1}^I M_i C_i [F/P, y_i, (n-1)t_c + t_i][P/F, x, (n-1)t_c + t_{r/2}] \quad (2.8) \end{aligned}$$

Now define an overall levelized fuel cycle cost,  $e_o$ , as that unit price in (time-zero) mills/kwhre which if charged uniformly during the whole life of the reactor will provide enough revenue to exactly compensate for all fuel cycle expenses. Thus, we can write

$$\begin{aligned} & \sum_{i=1}^N 1000 E e_n^* [F/P, y_e, (n-1)t_c + t_{r/2}][P/F, x, (n-1)t_c + t_{r/2}] \\ & \quad \sum_{i=1}^N 1000 E e_o [F/P, y_e' (n-1)t_c + t_{r/2}][P/F, x, (n-1)t_c + t_{r/2}] \quad (2.9) \end{aligned}$$

where  $N$  is the total number of equilibrium batches irradiated during the entire life of the reactor. Equation (2.9) can be written

$$\begin{aligned}
 & 1000 e_o \sum_{n=1}^N E[F/P, y_e, (n-1)t_c + t_{r/2}] [P/F, x, (n-1)t_c + t_{r/2}] \\
 &= \frac{1}{1-\tau} \sum_{n=1}^N \sum_{i=1}^I M_i C_i [F/P, y_i, (n-1)t_c + t_i] [P/F, x, (n-1)t_c + t_i] \\
 &\quad - \frac{1}{1-\tau} \sum_{n=1}^N \sum_{i=1}^I M_i C_i [F/P, y_i, (n-1)t_c + t_i] [P/F, x, (n-1)t_c + t_{r/2}]
 \end{aligned} \tag{2.10}$$

The present worth factor  $(P/F, x, t)$  can be decomposed as follows:

$$\begin{aligned}
 (P/F, x, T + t) &\equiv (1 + x)^{-(T+t)} = (1 + x)^{-T} (1 + x)^{-t} \\
 &= (P/F, x, T) (P/F, x, t)
 \end{aligned}$$

and similarly

$$(F/P, x, T + t) \equiv \frac{1}{(P/F, x, T + t)} = (F/P, x, T) (F/P, x, t)$$

Thus, Equation (2-10) can be summed over  $i$  to yield,

$$\begin{aligned}
 & 1000 e_o E(F/P, y_e, t_{r/2}) (P/F, x, t_{r/2}) \sum_{n=1}^N [F/P, y_e, (n-1)t_c] [P/F, x, (n-1)t_c] \\
 &= \sum_{i=1}^I M_i C_i \left\{ \frac{1}{1-\tau} (F/P, y_i, t_i) (P/F, x, t_i) \sum_{n=1}^N [(F/P, y_i, (n-1)t_c) (P/F, x, (n-1)t_c)] \right\} \\
 &\quad - \frac{\tau}{1-\tau} \sum_{i=1}^I M_i C_i \left\{ (F/P, y_i, t_i) (P/F, x, t_{r/2}) \sum_{n=1}^N [F/P, y_i, (n-1)t_c] [P/F, x, (n-1)t_c] \right\}
 \end{aligned} \tag{2.11}$$

The right hand side of Equation (2.11) can be written as

$$\sum_{i=1}^I M_i C_i \left\{ \left[ \frac{(P/F, x, t_i)}{1-\tau} - \left( \frac{\tau}{1-\tau} \right) (P/F, x, t_{r/2}) \right] (F/P, y_i, t_i) \right. \\ \left. \sum_{n=1}^N [F/P, y_i, (n-1)t_c] [P/F, x, (n-1)t_c] \right\} \quad (2.12)$$

Solving Equation (2.11) for  $e_o$ :

$$e_o = \frac{i}{1000 E} \sum_{i=1}^I M_i C_i \left\{ \left[ \frac{1}{1-\tau} \frac{(P/F, x, t_i)}{(P/F, x, t_{r/2})} - \frac{\tau}{1-\tau} \right] \frac{(F/P, y_i, t_i)}{(F/P, y_i, t_{r/2})} \right. \\ \left. \frac{\sum_{n=1}^N [F/P, y_i, (n-1)t_c] [P/F, x, (n-1)t_c]}{\sum_{n=1}^N [P/F, x, (n-1)t_c] [F/P, y_e, (n-1)t_c]} \right\} \quad (2.13)$$

Define the collective parameters:

$$F_i \equiv \left[ \frac{(P/F, x, t_i)}{(P/F, x, t_{r/2})} \right] \left[ \left( \frac{1}{1-\tau} \right) - \left( \frac{\tau}{1-\tau} \right) \right] \quad (2.14)$$

and

$$G_i \equiv \left[ \frac{(F/P, y_i, t_i)}{(F/P, y_e, t_{r/2})} \right] \left[ \frac{\sum_{n=1}^N [F/P, y_i, (n-1)t_c] [P/F, x, (n-1)t_c]}{\sum_{n=1}^N [P/F, x, (n-1)t_c] [F/P, y_d, (n-1)t_c]} \right] \quad (2.15)$$

Using these definitions in Equation (2.13), there results:

$$e_o \left[ \frac{\text{mills}}{\text{kwhr}} \right] = \frac{1}{1000 E} \sum_{i=1}^I M_i C_i F_i G_i \quad (2.16)$$

which is the final form of the Simple Model for the life time levelized fuel cycle cost in time-zero dollars. At this point it will be convenient and productive to simplify the  $G_i$  factor. First of all the summation in the numerator of  $G_i$  (Equation (2.15)) can be written as,

$$\begin{aligned} & \sum_{n=1}^N [F/P, y_i, (n-1)t_c] [P/F, x, (n-1)t_c] \\ &= \sum_{n=1}^N \frac{(1 + y_i)^{(n-1)t_c}}{(1 + x)^{(n-1)t_c}} = \sum_{n=1}^N \left[ \left( \frac{1 + y_i}{1 + x} \right)^{t_c} \right]^{n-1} \end{aligned}$$

This summation is a geometric series with initial value of 1 and common ratio of  $\left( \frac{1 + y_i}{1 + x} \right)^{t_c}$ , thus

$$\sum_{n=1}^N [F/P, y_i, (n-1)t_c] [P/F, x, (n-1)t_c] = \frac{1 - \left( \frac{1 + y_i}{1 + x} \right)^{Nt_c}}{1 - \left( \frac{1 + y_i}{1 + x} \right)^{t_c}}$$

$$= \frac{1 - \frac{[P/F, x, Nt_c]}{[P/F, y_i, Nt_c]}}{1 - \frac{(P/F, x, t_c)}{(P/F, y_i, t_c)}}$$

Similarly

$$\sum_{n=1}^N [F/P, y_e, (n-1)t_c] [P/F, x, (n-1)t_c] = \frac{1 - \frac{[P/F, x, Nt_c]}{[P/F, y_e, Nt_c]}}{1 - \frac{(P/F, x, t_c)}{(P/F, y_e, t_c)}}$$

Therefore

$$G_i = \left[ \frac{(P/F, y_e, t_r/2)}{(P/F, y_i, t_i)} \right] \left[ \frac{1 - \frac{[P/F, x, Nt_c]}{[P/F, y_i, Nt_c]}}{1 - \frac{[P/F, x, Nt_c]}{[P/F, y_e, Nt_c]}} \right] \left[ \frac{1 - \frac{(P/F, x, t_c)}{(P/F, y_e, t_c)}}{1 - \frac{(P/F, x, t_c)}{(P/F, y_i, t_c)}} \right] \quad (2.17)$$

To simplify the  $G_i$  factor, we define

$$Z = \frac{x - y}{1 + y} \quad (2.18)$$

Thus, with this definition one can write

$$(P/F, y, N)(P/F, Z, N) = (P/F, x, N)$$

Using the concept of uniform series present worth factor, namely

$$(P/A, i, N) = \frac{(1 + i)^N - 1}{i(1 + i)^N} \quad (2.19)$$

then the present worth factor, in terms of the uniform series present worth factor, can be written:

$$(P/F, x, N) = 1 - i(P/A, x, N) \quad (2.20)$$

with this definition

$$(P/F, x, N)/(P/F, y, N) = (P/F, Z, N) = 1 - Z(P/A, Z, N) \quad (2.21)$$

using Equation (2.21) in Equation (2.17)

$$G_i = \left[ \frac{(P/F, y_e, t_r/2)}{(P/F, y_i, t_i)} \right] \left[ \frac{(P/A, Z_i, Nt_c)}{(P/A, Z_e, Nt_c)} \right] \left[ \frac{(P/A, Z_e, t_c)}{(P/A, Z_i, t_c)} \right] \quad (2.22)$$

A similar expression for the  $G_i$  factor has been found by Stauffer et. al. (S-4)



Note that when  $y = y_e = 0$  (no escalation) from Equation (2.17),  $G_i = 1$  and Equation (2.16) simplifies to

$$e_o = \frac{1}{1000 E} \sum_{i=1}^I M_i C_i F_i \quad (2.23)$$

Thus  $G_i$  may be identified as a "composite escalation factor".

Also when  $x = 0$ , from Equation (2.14) it can be seen that  $F_i = 1$ .

Thus,  $F_i$  may be identified as a "composite discounting factor" and as can be seen from its definition, it is independent of  $N$ . Finally, when

$$y_i = y_e = y$$

$$G_i = (P/F, y, t_{r/2} - t_i) \quad (2.24)$$

Equation (2.16) together with Equations (2.14) and (2.17) or (2.22) provides a simple set of prescriptions for calculation of overall levelized fuel cycle costs. Although Equation (2.17) can be evaluated without recourse to a large computer, for a large number of steps ( $I$ ), or when dealing with many cases, the use of a digital computer will prove extremely convenient. Therefore a program has been written to find  $e_o$ , using the above equations. This program, SIMMOD, is described in Appendix B.

Although the preceding derivation has been somewhat tedious, the end results are of particular use in that they show in

straight-forward fashion the linear variation of  $e_o$  with  $M_i$ ,  $C_i$ ,  $F_i$  and  $G_i$  - an analytic result of great use in parametric sensitivity studies, linear programming analysis and many other subsequent analytic manipulations.

The quantity  $E$  appearing in Equation (2.16) is defined to be the total electrical energy produced by each identical equilibrium batch during its residence time in the core. This parameter can be written as

$$E(\text{KWhre}) = 8766 \cdot 10^3 \eta L H t_c \quad (2.25)$$

where

$\eta$  = Efficiency of unit, MWe/MWth

$L$  = capacity factor

$H$  = reactor thermal power rating (MWth)

$t_c$  = intra-refueling interval (years)

Here  $L$  is defined as the total energy which has been produced during time  $t_c$ , divided by the maximum energy which could have been produced during this time. Thus the refueling down time causes a reduction in the capacity factor. If we define the "availability-based capacity" factor,  $L'$ , the ratio of total energy which has been produced during time  $t_c$  to the maximum energy available during normal operation, Equation (2.25) can be written

$$E(\text{kwhre}) = 8766 \cdot 10^3 \eta L' H (t_c - t_{R.D.}) \quad (2.26)$$

where  $t_{R.D.}$  is refueling down time ( in years ). Therefore  $L$  and  $L'$  can be related as

$$L' = \frac{t_c}{t_c - t_{R.D.}} \quad L = \frac{L}{1 - \frac{t_{R.D.}}{t_c}} \quad (2.27)$$

Also,  $E$  can be written in terms of discharge burnup and heavy metal charged,

$$E(\text{kwhre}) = 24 \cdot 10^3 \eta B M \quad (2.28)$$

where

$B$  = burnup (MWD/MTHM)

$M$  = heavy metal charged to the reactor in a steady state batch  
(metric ton/batch)

### 2.2.2 Fuel Cost as an Expensed Cost

In the previous section we considered the fuel as a depreciable investment. Now we will consider it as an operation and maintenance cost as is the case for other kinds of fuel such as coal or oil. Revenue from the sale of electricity is again balanced against expenses. Note that in this case we will assume that the only source of "revenue" is from sale of electricity, and back-end credits such as those for ore or separative work will be considered as "negative expenses".

Therefore the present worth of revenue with respect to the origin of the time coordinate in the previous section should be equal to the present worth of all expenses. On this basis we can write

$$\begin{aligned}
& 1000e_o E(F/P, y_e, t_{r/2})(P/F, x, t_{r/2}) \sum_{n=1}^N [(F/P, y_e, (n-1)t_c)(P/F, x, (n-1)t_c)] \\
& = \sum_{n=1}^N \sum_{i=1}^I [M_i C_i (F/P, y_i, t_i)(P/F, x, t_i)(F/P, y_i, (n-1)t_c)(P/F, x, (n-1)t_c] \\
& \hspace{20em} (2.29)
\end{aligned}$$

In derivation of Equation (2.29) all prior assumptions introduced in Section 2.2.1, have been retained and re-employed. Solving Equation (2.29) for  $e_o$ , and with mathematical manipulations paralleling those of the preceding section, there results:

$$\begin{aligned}
e_o &= \frac{1}{1000 E} \sum_{i=1}^I M_i C_i \left[ \frac{(P/F, x, t_i)}{(P/F, x, t_{r/2})} \right] \left[ \frac{(F/P, y_i, t_i)}{(F/P, y_e, t_{r/2})} \right] \\
& \quad \left[ \frac{\sum_n [F/P, y_e, (n-1)t_c][P/F, x, (n-1)t_c]}{\sum_n [F/P, y_i, (n-1)t_c][P/F, x, (n-1)t_c]} \right] \\
& \hspace{20em} (2.30)
\end{aligned}$$

Define

$$P_i \equiv \frac{(P/F, x, t_c)}{(P/F, x, t_{r/2})} \hspace{10em} (2.31)$$

The same definition for  $G_i$  as given by Equation (2.17) again applies; one can then write

$$e_o = \frac{1}{1000 E} \sum_{i=1}^I M_i C_i P_i G_i \hspace{10em} (2.32)$$

which is the version of the Simple Model applicable if we consider fuel expenses as operating costs. Comparison of Equations (2.32) and (2.14) shows that  $P_i$  is merely  $F_i$  with  $\tau$  set equal to zero: but note that the effect of  $\tau$  will remain due to its involvement in the discount rate ( $x$ ).

## 2.3 Computer Codes for Fuel Cycle Cost

### 2.3.1 MITCOST-II

MITCOST-II (C-1) is based upon Vondy's modified discount factor approach (V-1), (S-1), using present worth techniques to evaluate the levelized fuel cycle cost as revenue requirement per batch and per period, and the overall levelized fuel cycle cost and overall revenue requirement. This code can use four different types of depreciation methods, namely: energy depreciation, straight line depreciation, sum-of-the-years-digits depreciation and double declining balance depreciation. Four different type of taxes: federal income tax, state income tax, state gross revenue taxes, and local property taxes, have been considered in this code. The number of tax payment periods and the number of billing (revenue) periods per year can be taken from the set of 1, 2, 3, 4, 6, 12, and tax payments can occur at times which differ from those at which billing occurs.

Energy generation for each batch of fuel must be provided as input by introducing two of 6 parameters which include burnup, electrical or thermal energy, availability-based capacity factor, length of irradiation and time at which irradiation begins. Charged and discharged masses must also be specified for each batch. The other important parameters which must be given as input data are: lag times or lead times and unit prices for each transaction and economic and financial parameters, such as tax rate, stock and bond rate of return. Output results include: energy history, mass flow, levelized fuel cycle cost and revenue requirement for each batch and/or each period, overall levelized fuel cycle cost and overall revenue requirement, and, if desired, a cash flow tabulation.

It should be noted that MITCOST-II has been written for the recycle mode, and thus back end credits for ore and separative work are calculated by the code and employed in the determination of levelized fuel cycle cost and other economic indices. It was necessary, therefore to make some minor modifications to the code to allow it to handle the once-through or throwaway mode. This modification is discussed in Appendix C. It should be noted that the escalation rate of each step in fuel cycle can be introduced as an input data to the code. However, the price of electricity can not be escalated in this code. This can be done in SIMMOD.

### 2.3.2 GEM

The GEM (H-1) code also uses the Vondy's approach, this time combined with continuous discounting to calculate levelized fuel cycle cost. This code uses only the energy depreciation method (unit-of-production depreciation) and has provisions only for accommodating federal income taxes (or a combined equivalent federal and state income tax); no property taxes have been considered. Similar to MITCOST-II, GEM is designed to predict fuel cycle cost for any type of nuclear system (LWR HTGR, LMFBR...) Inventory charges and depreciation are assumed to occur at a discrete point in time, but revenue from the sale of electricity has been assumed to be continuous.

The input data are quite similar to MITCOST-II. The output results are the economic analysis of a batch in three forms, namely, cash flow, allocated costs and yearly cash flow. The cash flow analysis divides batch life into three different periods, which are pre-irradiation time, irradiation time and post-irradiation time, and for each period the levelized cash flow for major transactions is printed out. The total levelized cash flow yields

the levelized fuel cycle cost in cents/Btu and/or cents/kwhr. In the allocated cost analysis, all major costs are divided into two parts: expensed costs and inventory costs. Again the total of expenses and inventory costs for all steps will give us the overall levelized fuel cost. The yearly cash flow analysis gives the cash flow occurring during each year the batch is in existence for major fuel cycle transactions. The newest version of GEM, GEM-III, also performs a sensitivity analysis.

### 2.3.3 A Comparison of MITCOST with GEM

A comparison between MITCOST and GEM has been done by Brehm and Spriggs (B-1) for a one batch LWR fuel cycle case with uranium and plutonium recycle. Their results are shown in Table(2.1), and as can be seen, there is good agreement (within 0.13%) between the most recent versions of these codes. Therefore either one of these codes could be used as a proven method to validate the Simple Model. Since MITCOST-II was available and operational at MIT, and a certain amount of in-house experience with its use had been accumulated over the past several years, MITCOST-II was selected as the reference program.

Other important codes for economic analysis of fuel cycle cost are: GACOST (A-1) which is modernized version of PWCOST (L-1), CINCAS(F-1) which has some similarity to GEM, CINCAS-II, which is another name for the newest version of GEM, namely GEM-III, REFCO or POW76 (S-2), NUS FUELCOST 1A (K-1)

All deal with the same input parameters in much the same fashion if consistently applied, and therefore we will do no more than call attention to their existence here, in the interest of completeness.

TABLE 2-1  
 A NUMERICAL COMPARISON OF RESULTS BETWEEN THE  
 ORIGINAL AND MODIFIED VERSIONS OF GEM AND MITCOST\*

	Original MITCOST	Modified MITCOST	Original GEM	Modified GEM
Batch Levelized Cost (mills/kwhe)	5.3223	5.3524	5.3402	5.3458
Non-time-valued Costs (10 <sup>6</sup> \$)				
Uranium Ore	7.3483		7.3377	7.3483
Fabrication	2.5520			
Uranium Credit	1.7339	1.6429	1.6480	1.6511
Plutonium Credit	2.5491			
Shipping	.4983		.4917	
Reprocessing	2.9900		2.9503	
Total Discounted Energy (10 <sup>9</sup> kwhe)	2.3271		2.3351	
Total Discounted Cost (10 <sup>7</sup> \$)	1.2386	1.2456	1.2470	1.2483

\*Reported in Reference (X-1) for a one-batch LWR fuel cycle for the Uranium and Plutonium recycle mode



## 2.4 Comparison of Simple Model with MITCOST-II

### 2.4.1 Base Case Study

In this section a reactor system is chosen and its fuel cycle cost is calculated with the Simple Model and with MITCOST-II, and then the results are compared to demonstrate the validity of the Simple Model. The system which was selected for this purpose is system-80<sup>TM</sup>, which is a typical 3-batch PWR, designed by Combustion Engineering, (however, it should be noted that the results and the validity of the conclusions are not sensitive to the specific LWR design chosen). Table (2.2), shows the fuel cycle characteristics of the system 80<sup>TM</sup> PWR (F-2). The data given in Table (2.2) are for steady state batches. Mass and burnup parameters for nonequilibrium batches are given in Table (2-3) (P-1). On the basis of information given in Tables (2-2) and (2-3) the quantity of each fuel cycle transaction has been calculated and listed in Table (2-4) for steady state batches. Also shown in this table are the other parameters necessary for calculation of fuel cycle cost. The unit prices are the same as those used by C.E. (S-3) for a recent economic study. Using the data given in the table, the levelized fuel cycle cost is,

$$\bar{e}_o(\text{Simple Model}) = 5.717 \text{ mills/kwhre}$$

$$\bar{e}_o(\text{MITCOST-II}) = 5.865 \text{ mills/kwhre}$$

The Simple Model differs from MITCOST-II by

$$\left( \bar{e}_{oSM} - \bar{e}_{oMITCOST} \right) \div \bar{e}_{MITCOST} = - 2.52\%$$

which is acceptable for the purpose of the current study.

TABLE 2-2  
CHARACTERISTICS OF A REPRESENTATIVE PWR\*

Number of fuel assemblies	241
Number of fuel rods	56,876
Core equivalent diameter	143 in. (363.2 cm)
Active fuel length	150 in. (381.0 cm)
Total core heat output	3800 MW
Average linear heat rate	5.34 kw/ft (175.8 w/cm)
Primary system pressure	2250 psi (15513.2 Kpa)
Core inlet temperature	565 °F (569.3 °K)
Core outlet temperature	621 °F (600.4 °K)
Average full power moderator temperature	549 °F (585.4 °K)
Fuel management	3 batches, mixed central zone
Average cycle burnup	101,20 MWD/MTHM
Average reload enrichment	3.07
Discharge exposure	30636 MWD/MTHM
Capacity factor	75%
Fissile residual in discharged fuel	
total fissile (w/o)	1.55
U-235 (w/o)	0.86
fissile Pu (w/o)	0.69

\*CE's system 80<sup>TM</sup> (F-2)

TABLE 2-3

## CHARACTERISTICS OF CORE START-UP BATCHES

<u>Batch Number</u>	<u>Initial Enrichment (w/o)</u>	<u>HM Charged (MTU)</u>	<u>Discharged Enrichment <math>^{235}\text{U}</math> (w/o)</u>	<u>Total <math>^{235}\text{U}</math> Discharged (kg)</u>	<u>Total Fissial Pu Discharged gr/kg HM Charged</u>	<u>Discharged Burnup (MWD/MTHM)</u>
1	1.66	34.119	0.73	243	4.002	12,748
2	2.21	32.232	0.69	214	4.484	21,811
3	2.81	32.962	0.77	244	5.031	28,997
4 (steady state)	3.07	34.190	0.86	287	6.800	30,360

TABLE 2-4

## BASE CASE FUEL CYCLE TRANSACTIONS

<u>Transaction</u>	<u>Lead or Lag Time*(yr)</u>	<u>Unit Cost</u>	<u>Quantity</u>
Pay for $U_3O_8$	-1.0467	35 \$/lb	$5.005 \times 10^5$ lb
Pay for conversion or for $UF_6$	-0.5417	4.0 \$/kg	$1.9155 \times 10^5$ kg
Pay for separative** work	-0.5417	85 \$/SWU	$1.5211 \times 10^5$ kg SWU
Pay for fabrication	-0.2083	101.0 \$/kg	$3.3764 \times 10^4$ kg
Pay for shipping fuel to reprocessing	0.5	15.0 \$/kg	$3.3764 \times 10^4$ kg
Pay for reprocessing	0.75	150.0 \$/kg	$3.3764 \times 10^4$ kg
Pay for waste disposal	0.75	100.0 \$/kg	$3.3764 \times 10^4$ kg
Credit for $U_3O_8$	1	-35 \$/lb	$1.1246 \times 10^5$ lb $U_3O_8$
Credit for conversion or for $UF_6$	1	- 4.0 \$/kg	$3.3764 \times 10^4$ kg
Credit for separative work	1	-85 \$/kg	$5.896 \times 10^3$ kg SWU
Credit for Pu	1	-27140 \$/kg	230.0 kg

ENERGY HISTORY

$$E = 8.41462 \times 10^4 \text{ kWhre}$$

$$H = 3800 \text{ MWth}$$

$$N = 30 \text{ Batches}$$

$$\eta = 0.342, \text{ MWe/MWTH}$$

$$t_{R.D.} = 0.125 \text{ (yr), refueling downtime}$$

TABLE 2-4

(continued)

$$t_c = 0.9849 \text{ yrs.}$$

$$t_R = 2.8297 \text{ yrs.}$$

$$L = 0.75$$

$$L' = 0.8599$$

ECONOMIC PARAMETERS

$$\tau = 50\%$$

$$f_b = 0.5$$

$$f_s = 0.5$$

$$r_b = 8\%$$

$$r_s = 14\%$$

$$\dagger^* x = 9\%$$

$$y_i = y_e = 0.0$$

\*\*\*Billing periods per year = 12

\*\*\*Tax periods per year = 4

\*Lag times are given with respect to the time at which the batch was discharged, i.e. they must be incremented by the irradiation interval ( $t_R = 2.9547$  yrs.) in fuel cycle cost calculations.

\*\*Tails assay enrichment is assumed to be 0.2% (w/o)

\*\*\*Only for use in MITCOST-II

$$\dagger^* x = (1 - \tau)f_b r_b + f_s r_s$$

#### 2.4.2 Parametric Variations and Sensitivity Analysis

In this section the parameters whose effect on the levelized fuel cycle cost are most pronounced are varied, and thus their effect on the discrepancy between MITCOST-II and the Simple Model is studied. The most important parameter is ore cost, since on the order of 50% of the fuel cost for a LWR is attributable to the purchase of yellowcake. Equation (2-16) shows that if all other parameters are held constant,  $e_o$ , the overall levelized fuel cycle cost, is a linear function of ore price ( $C_{U_3O_8}$ ). This fact is shown in Figure (2.4), accompanied by the results from MITCOST-II calculations. As can be seen from this figure the linearity of  $\bar{e}_o$  with  $C_{U_3O_8}$  is also confirmed by the MITCOST-II results. Also from this figure, note that for the highest price of  $U_3O_8$  considered (90 \$/lb) the discrepancy between the Simple Model and MITCOST-II is less than -3%.

Table 2.5 shows the overall levelized fuel cycle cost when all parameters are the same as for the base case with the exception of the varied parameter specified in the table. From this table it can be seen that the error in the Simple Model is less than -3% (with the exception of  $\tau = 0$ , where it is slightly larger). Moreover the model is consistently biased. The important variable of ore cost escalation rate has also been studied: values up to 6% per year were examined for base-case economics. The results are indicated in Table 2-6.

These results show that there is good agreement between the Simple Model and MITCOST-II. The difference between models is almost always less than -3%, averaging approximately -2%, more than adequate for present purposes. Furthermore, the differences are readily explained as consequences of the

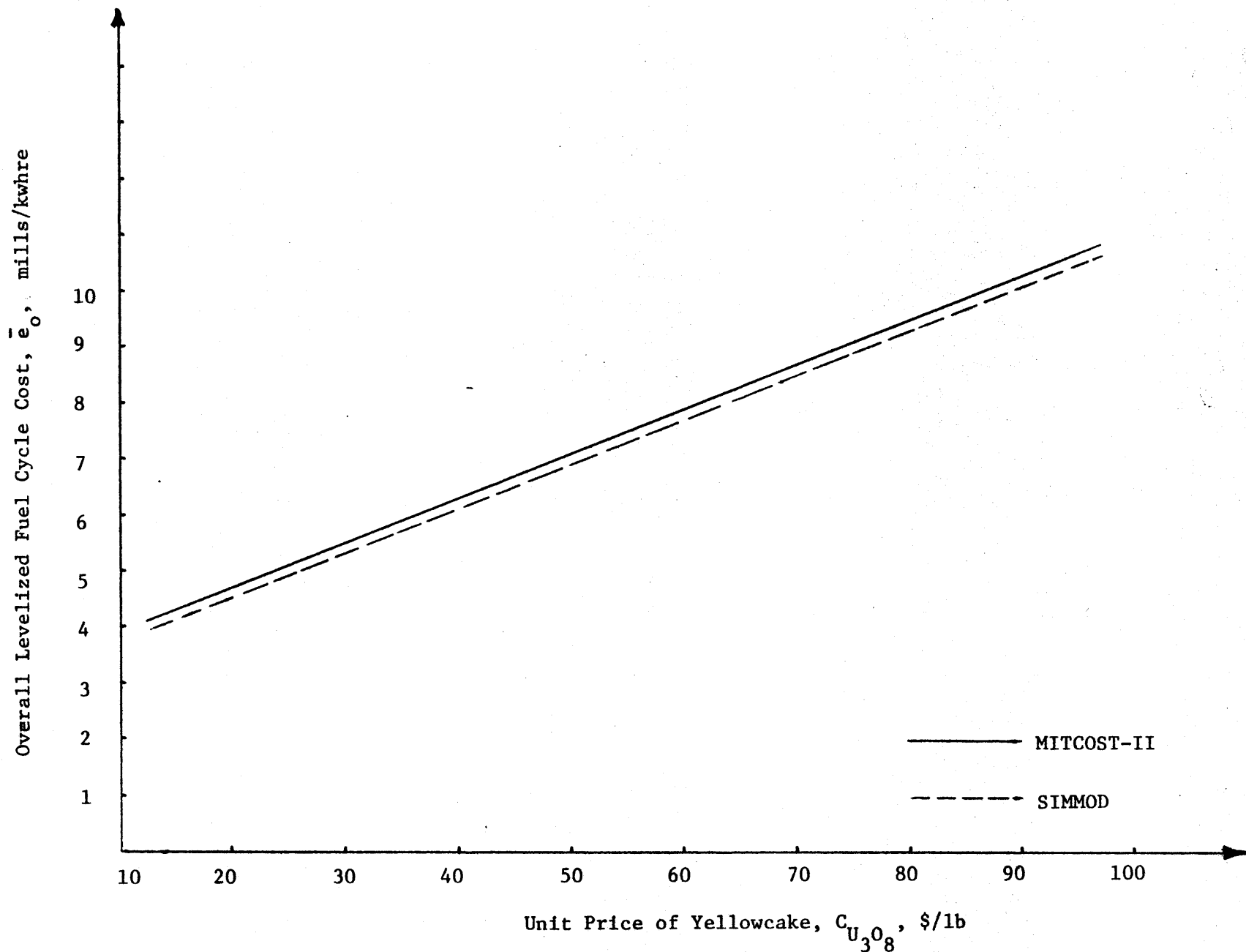

Figure 2.4 Variation of Overall Levelized Fuel Cycle Cost with Ore Cost

TABLE 2-5

## COMPARISON OF MITCOST AND SIMPLE MODEL FOR SEVERAL PARAMETRIC VARIATIONS

<u>Parameter Varied From the Case Base</u>	<u>Value Used</u>	$\bar{e}_o$ <u>MITCOST-II</u>	$\bar{e}$ <u>Simple Model</u>	<u>% Difference*</u>
Discount Rate	0.05	5.002	4.888	-2.28%
	0.14	6.992	6.794	-2.83%
Unit Price of $U_3O_8$	15 \$/1b	4.256	4.132	-2.93%
	55 \$/1b	7.471	7.302	-2.29%
	90 \$/1b	10.288	10.076	-2.06%
Lead Time for Purchasing $U_3O_8$	- 2 years	6.327	6.157	-2.68%
Lag Time for Reprocessing	4.0 years	5.921	5.802	-2%
	8.0 years	5.967	5.873	-1.57%
Availability Based Capacity Factor	0.54	6.531	6.412	-1.83%
	0.95	5.756	5.608	-2.57%
Tax Rate	0.0	5.186	5.015	-3.3%

$$*Diff = [(e_{S.M.} - e_{MITCOST}) / e_{MITCOST}] 100$$



TABLE 2-6

## EVALUATION OF THE EFFECT OF ORE ESCALATION RATE

<u>Escalation Rate</u> <u>% per year</u>	$\bar{e}_o$ <u>MITCOST-II</u>	$\bar{e}_o$ <u>Simple Model</u>	<u>% Difference*</u>
2%	6.253	6.165	- 1.4%
4%	6.763	6.758	- 0.07%
6%	7.442	7.551	+ 1.45%

$$* \% \text{ Difference} = \left[ \frac{\bar{e}_{\text{S.M.}} - \bar{e}_{\text{MITCOST}}}{\bar{e}_{\text{MITCOST}}} \right] \cdot 100$$

additional simplifying assumptions in the Simple Model, as explained in the next section.

It should be noted that the discrepancy between these two models increases as the discount rate is increased. However, even for high discount rate (14%) the discrepancy is less than -3% (see Table 2-5).

## 2.5 Analysis of Approximations

### 2.5.1 Effect of Startup Batches

To assess the effect of startup batches on the difference between the Simple Model and MITCOST-II, a general approach will be introduced for a reactor system consisting of M startup batches and N equilibrium batches. For each of the M-1 startup batches, the Simple Model, Equation (2-16), is considered for the case when N=1 (a single batch) to calculate the levelized fuel cycle cost. Note that for each startup batch the electrical energy produced, the irradiation time and lag times are different, and thus  $F_i$  and  $G_i$  change for each startup batch. The levelized fuel cycle cost for the  $j^{\text{th}}$  batch of the M startup batches can be written from Equation (2-16) by using N=1, thus;

$$e_j = \frac{M}{jE} \sum_{i=1}^I M_i C_i F_{ij} G_{ij} \quad (2.33)$$

where;

$j = 1, 2, 3, \dots, M-1$  (since the  $M^{\text{th}}$  batch is an equilibrium batch and is considered in N)

$$F_{ij} = \frac{1}{1-\tau} \frac{(P/F, x, t_{rj} + T_i)}{(P/F, x, t_{rj}/2)} - \frac{\tau}{1-\tau} \quad (2.34)$$

$$G_{ij} = \frac{(P/F, y_e, t_{rj}/2)}{(P/F, y_i, t_{rj} + T_i)} \quad (2.35)$$

$$t_j = jt_C - t_{R.D.} \quad (2.36)$$

$T_i$  = Absolute lead or lag time (Note that  $T_i$  is equal to  $t_i$ , defined previously for front-end transactions and it is equal to  $t_i + t_r$  for back end transactions)

Other parameters have the same definitions as before.

According to the definition of overall levelized fuel cycle cost (including startup batches), one can write

$$\bar{e}_o = \frac{\frac{Ee_1}{M} + \frac{2Ee_2}{M} + \dots + \frac{jEe_j}{M} + \dots + \frac{M-1}{M} Ee_m + e_{s.s.} E(P/A, x, Nt_c)}{\frac{E}{M} + \frac{2E}{M} + \dots + \frac{jE}{M} + \dots + \frac{M-1}{M} E + E(P/A, x, Nt_c)} \quad (2.37)$$

In Equation (2-37),  $e_{s.s.}$  is the overall levelized fuel cycle cost for  $N$  equilibrium batches (steady-state batches) which can be calculated, using Equation (2-16), and  $(P/A, x, Nt_c)$  is the uniform series present worth factor, which has been defined as

$$(P/A, x, Nt_c) = \frac{(1+x)^{Nt_c}}{x(1+x)^{Nt_c}} \quad (2.38)$$

Equation (2.37) is approximate since we have assumed all revenues and expenses occur at time zero for all startup batches and at the end of year  $N$  for all steady state batches.

Equation (2-37) can be simplified to yield

$$e_o = \frac{\frac{1}{M} \sum_{j=1}^{M-1} j e_j + e_{s.s.} (P/A, x, Nt_c)}{\frac{M-1}{2} + (P/A, x, Nt_c)} \quad (2.39)$$

Equation (2.39) with the aid of Equation (2.16) give the overall levelized fuel cycle cost including the effect of startup batches.

For a three batch reactor Equation (2.39) reduces to

$$e_o = \frac{\frac{1}{3} e_1 + \frac{2}{3} e_2 + e_{s.s.} (P/A, x, Nt_c)}{1 + (P/A, x, Nt_c)} \quad (2.40)$$

To evaluate the effect of startup batches, Equation (2.40) was used for the base-case problem previously defined. With the data given in Table (2-3) and (2-4) and by employing Equation (2.33) for the first and second startup batches, one obtains:

$$e_1 = 8.166 \text{ mills/kwhre}$$

$$e_2 = 6.04 \text{ mills/kwhre}$$

then, by using Equation (2.40) the overall levelized fuel cycle cost is

$$\bar{e}_o = 5.808 \text{ mills/kwhre}$$

where  $\bar{e}_{s.s.}$  was given in Section (2.4.1) as 5.717 mills/kwhre and  $(P/A, x, Nt_c)$  was calculated to be 10.2736 using Equation (2-38) with data from Table (2-4). Compare this result with  $\bar{e}_o$  from MITCOST-II which is

$$\bar{e}_o (\text{MITCOST-II}) = 5.865 \text{ mills/kwhre}$$

The difference between the startup batch corrected Simple Model and MITCOST-II is -0.9%, which is a factor of three smaller than the discrepancy if the two startup batches are ignored. Thus this analysis indicates that about 2/3 of the discrepancy between the Simple Model and MITCOST-II is due to the neglect of startup batches.

An indirect indication of the effect of startup batches can be obtained by analysis of a batch-loaded reactor (where all batches can be considered as equilibrium batches, and there are no "startup" batches). For this purpose a batch-loaded PWR studied in Ref. (R-1) was selected and the overall levelized fuel cycle cost was determined using Equation (2-16). The specifications of this batch-loaded reactor are given in Table (2-7). Unit prices and lag or lead times are the same as for the base-case (Table (2-4)). Table (2-8) shows the quantities per transaction. Using the above information and Equation (2.16), the overall levelized fuel cycle cost was found to be:

$$\bar{e}_0 \text{ (Simple Model)} = 17.190 \text{ mills/kwhre}$$

and from MITCOST-II

$$\bar{e}_0 \text{ (MITCOST-II)} = 17.044 \text{ mills/kwhre}$$

The difference is + 0.85%, which again suggests that about 2/3 of the discrepancy is due to the startup batches, in view of the fact that a consistent discrepancy of roughly -2% was found in all of the prior parametric studies on three-batch cores.

TABLE 2-7  
 CHARACTERISTICS OF 250 MWth, BATCH-LOADED PWR

Mass Charge and Discharged

Heavy metal charged	9703.3 kg
Heavy metal discharged	9351 kg
Initial enrichment (w/o of U <sup>235</sup> )	4.597
Final enrichment of U <sup>235</sup> (w/o)	2.30
Fissile Pu Discharged	69 kg

Energy History

Discharge burnup	25516 MWD/MT
Heat rate	250 MWth
Efficiency of unit	0.24 MWe/MWth
Capacity factor	0.6

Fuel Management Parameters

1 batch reactor	
Equilibrium batches	5
Irradiation time	4.595 yrs
Refueling down time	1 month

Economic Parameters

Discount rate	10%
All escalation rates	0.0%

TABLE 2.8

## TRANSACTION QUANTITIES FOR BATCH LOADED PWR

<u>TRANSACTION</u>	<u>Quantity</u>
Purchase of $U_3O_8$	220,379.0 lb
Conversion to $UF_6$	84,337.3 kg
Separative work*	77,573.7 kg SWU
Fabrication	97,033.0 kg
Fuel shipped to reprocessing	93,510.0 kg
Waste disposal	93,510.0 kg
Credit for $U_3O_8$	100,487.4 lb $U_3O_8$
Credit for separative work*	26,402.0 kg SWU
Credit for fissile Pu	69.0 kg

\*tails assay enrichment was assumed to be 0.2% (w/o)

### 2.5.2 Effect of Shutdown Batches

As mentioned before, the shutdown batches should have a small effect on the overall levelized fuel cycle cost. To confirm this assertion,  $m$  shutdown batches will be considered, of which the first is considered an equilibrium batch and  $m-1$  are nonequilibrium batches, for which individual levelized fuel cycle costs can be calculated using Equation (2.33). Using the definition of overall levelized fuel cycle cost, and also considering  $M$  startup batches, as discussed in section 2.5.1, then one can write (see Equation(2.41)on next page).

In a more compact form:

$$\bar{e}_o = \frac{\frac{1}{m} \sum_{j=1}^{m-1} j [e_j + (P/F, x, (N + m - j - 1)t_c) e_{N + m - j}] + e_{S.S.} (P/A, x, Nt_c)}{\frac{m-1}{2} + (P/A, x, Nt_c) + \frac{1}{m} \sum_{j=1}^{m-1} j (P/F, x, (N + m - j - 1)t_c)} \quad (2.42)$$

Since we can assume that

$$e_j = e_{N + m - j}$$

(the  $j^{\text{th}}$  batch among the startup batches is similar to the  $(N + m - j)^{\text{th}}$  batch of the shutdown batches) then

$$\bar{e}_o = \frac{\frac{1}{m} \sum_{j=1}^{m-1} j [1 + P/F, x, (N + m - j - 1)t_c] e_j + e_{S.S.} (P/A, x, Nt_c)}{\frac{m-1}{2} + \frac{1}{m} \sum_{j=1}^{m-1} j (P/F, x, (N + m - j - 1)t_c) + (P/A, x, Nt_c)} \quad (2.43)$$



$$\bar{e}_o = \frac{A}{B} \quad (2.41)$$

$$A = \frac{Ee_1}{m} + \frac{2Ee_2}{m} + \dots + \frac{jEe_j}{m} + \dots + \frac{m-1}{m} e_j + e_{ss} E(P/A, x, Nt_c)$$

$$+ \left(\frac{m-1}{m}\right) E[P/F, x, Nt_c] e_{N+1} + \left(\frac{m-2}{m}\right) E[P/F, x, Nt_c] e_{N+2} + \left(\frac{m-k}{m}\right) [P/F, x, (N + K - 1)t_c]$$

$$+ \dots + \frac{E}{M} [P/F, x, (N + m - 2)t_c] e_{N + m - 1}$$

$$B = \frac{E}{m} + \frac{2E}{m} + \dots + \frac{JE}{m} + \dots + \frac{m-1}{m} E + E(P/A, x, Nt_c) + \frac{m-1}{m} E[P/F, x, Nt_c] + m$$

$$+ \frac{m-k}{k} [P/F, x, (N + k - 1)t_c] + \dots + \frac{E}{m} [P/F, x, (N + m - 2)t_c]$$

For a three-batch reactor from Equation (2.43)

$$\bar{e}_o = \frac{\frac{1}{3} [1 + (P/F, x, (N+1)t_c)] e_1 + \frac{2}{3} [1 + P/F, x, Nt_c] e_2 + e_{S.S.} (P/A, x, Nt_c)}{1 + (P/A, x, Nt_c) + \frac{1}{3} (P/F, x, (N+1)t_c) + \frac{2}{3} (P/F, x, Nt_c)} \quad (2.44)$$

For the base case, using the data from Table(2-4) and other information as given in Section 2.5.1, one can obtain:

$$\bar{e}_o = 5.8092$$

If this result is compared with the overall levelized fuel cycle cost given in Section 2.5.1 where only startup batches were considered (5.808) then it can be concluded that the shutdown batches have a very small effect on overall levelized fuel cycle cost. We are therefore fully justified in ignoring them. Furthermore there is also the option of using steady state batches throughout, and employing the partially-burned end-of-reactor life batches to start up a replacement reactor.

### 2.5.3 Effect of Using a Single Cash Flow for Revenue and Depreciation

To reveal the effect of using a single cash flow, in which the revenue and depreciation charges occur at the middle of the irradiation period, we can instead assume that they occur continuously during the time of irradiation. For this case, Equation (2-10) can be written as:

$$\begin{aligned}
1000 e_o E \sum_{n=1}^N \frac{1}{t_r} (F/\bar{A}, y_e, t_r) (F/P, y_e, (n-1)t_c) (P/\bar{A}, x, t_r) (P/F, x, (n-1)t_c) \\
= \sum_{n=1}^N \frac{1}{1-\tau} \sum_{i=1}^I M_i C_i [F/P, y_i, (n-1)t_c + t_i] [P/F, x, (n-1)t_c + t_i] \\
- \sum_{n=1}^N \frac{\tau}{1-\tau} \sum_{i=1}^I \frac{1}{t_r} M_i C_i [F/P, y_i, (n-1)t_c + t_i] [P/F, x, (n-1)t_c] (P/\bar{A}, x, t_r)
\end{aligned} \tag{2.45}$$

with some manipulation one can express the results in the form of the Simple Model expression;

$$e_o = \frac{1}{1000 E_o} \sum_{i=1}^I M_i C_i F_{ci} G_{ci} \tag{2.46}$$

where for this case

$$F_{ci} = \frac{1}{1-\tau} \frac{(P/F, x, t_i)}{\frac{1}{t_r} (P/\bar{A}, x, t_r)} - \frac{\tau}{1-\tau} \tag{2.47}$$

$$G_{ci} = \left[ \frac{(F/P, y_e, t_r/2)}{\frac{1}{t_r} (F/\bar{A}, y_e, t_r)} \right] G_i \tag{2.48}$$

$$(P/\bar{A}, x, t_r) = (e^{xt_r} - 1)/x e^{xt_r} \tag{2.49}$$

$$(F/\bar{A}, y_e, t_r) = (e^{y_e t_r} - 1)/y_e \tag{2.50}$$

Using the data given in Table (2-4) for the base-case, the overall levelized fuel cycle cost from Equation (2.46) is

$$e_o(\text{S.M.}) = 5.7425$$

whereas from MITCOST-II:

$$e_o(\text{MITCOST-II}) = 5.865$$

and thus

$$\frac{e_o(\text{S.M.}) - e_o(\text{MITCOST-II})}{e_o(\text{MITCOST-II})} \times 100 = -2 \%$$

which is only slightly smaller than before. Thus it can be said that the effect of the simple cash flow approximation is small, amounting perhaps to about 1/5 of the overall discrepancy. It was shown in a previous section that  $\sim 2/3$  of the discrepancy between the Simple Model and MITCOST-II is due to the neglect of startup batches. The remainder of the discrepancy between these two models can be attributed to the greater detail in MITCOST-II (and corresponding simplifying assumptions in the Simple Model) such as using different periods for billing and tax payments. Since the combined effect of all of these simplifications contributes but a small fraction of the discrepancy ( $\sim 2/15$  of 3%) between these two models, no further analysis of approximations and differences was considered necessary.

## 2.6 Summary and Conclusions

In this chapter a simple and accurate model was developed for the calculation of overall levelized fuel cycle cost. Two major assumptions employed in the derivation of this Simple Model are: only equilibrium batches (defined in Section (2.2.1)) were considered, and revenue and depreciation charges were assumed to occur at the mid point of the irradiation period. On the basis of these assumptions the Simple Model was found to take the form:

$$e_o \text{ (mills/kwhre)} = \frac{1}{1000 E} \sum_{i=1}^I M_i C_i F_i G_i \quad (2.16)$$

where

$$F_i = \left[ \frac{(P/F, x, t_i)}{(P/F, x, t_{r/2})} \right] \left( \frac{1}{1-\tau} \right) - \left( \frac{\tau}{1-\tau} \right) \quad (2.14)$$

$$G_i = \left[ \frac{(P/F, y_e, t_{r/2})}{(P/F, y_i, t_i)} \right] \left[ \frac{(P/A, Z_i, Nt_c)}{(P/A, Z_e, Nt_c)} \right] \left[ \frac{(P/A, Z_e, t_c)}{(P/A, Z_i, t_c)} \right] \quad (2.22)$$

$$Z = (x-y)/(1 + y) \quad (2.18)$$

This model was checked against MITCOST-II and the discrepancy was shown to be less than 3% in the range of interest for all key independent valuables. The results were consistently biased on the low side: hence differences are quite accurately reproduced. The analysis of the approximations revealed that two-thirds of the discrepancy is due to the omission of startup batches in the Simple Model. To obtain a more accurate

result one can use Equation (2.39) to analyze the startup batches, and thereby decrease the discrepancy. Using continuous discounting for revenue and depreciation instead of one cash flow at the middle of the irradiation period showed that on the order of one-fifth of the discrepancy between MITCOST-II and the Simple Model is due to this single cash flow approximation. Table (2-9) shows the overall levelized fuel cycle cost for the base case, described in Table (2-4), using MITCOST-II and different versions of the Simple Model. We conclude that the accuracy of the Simple Model has been confirmed by MITCOST-II. As a result this model can now be employed for determination of overall levelized fuel cycle costs, as will be done in the remainder of this report.

TABLE 2-9

## THE OVERALL LEVELIZED FUEL CYCLE COST FOR THE BASE CASE\*

<u>Description</u>	<u>Equation Number</u>	<u>Overall Levelized Fuel Cycle Cost <math>\bar{e}_o</math>, mills/kwhre</u>	<u>% Diff. **</u>
MITCOST-II	-	5.865	0.0
Simple Model	(2-16)	5.717	-2.52%
Simple Model with the effect of Startup Batches	(2-39)	5.808	-0.9%
Simple Model with the effect of Startup and shutdown batches	(2-43)	5.809	-0.9%
Simple Model with Continuous Discounting	(2-46)	5.742	-2.0%

\*see Table (2-4) for the base-case

$$**\% \text{ Diff} = 100 \cdot (e_{\text{S.M.}} - e_{\text{MITCOST}}) / e_{\text{MITCOST}}$$

## CHAPTER 3

## ECONOMIC ANALYSIS OF COUPLED FUEL CYCLES

## 3.1 Introduction

The purpose of the work reported in this chapter is to find the economic optimum value of the fuel-to-moderator volume ratio, where the overall levelized fuel cycle cost is a minimum, for coupled fuel cycles and to compare the results with those based upon optimization of minimize ore usage. Three systems, namely  $^{235}\text{U}/\text{U}$  units coupled with  $\text{Pu}/\text{U}$  units,  $^{235}\text{U}/\text{Th}$  reactors coupled to  $^{233}\text{U}/\text{Th}$  reactors (for both segregated and non-segregated recycle of  $^{233}\text{U}$  and  $^{235}\text{U}$  in the discharged fuel), and finally the  $^{235}\text{U}/\text{U}$  system without recycle, will be considered here. The SIMMOD code described in Appendix B, based on the "simple model" developed in the preceding chapter, is employed for fuel cycle cost calculations. The economic analysis assumes that fissile material is bought and sold at its indifference value. The effects of ore price and the scarcity-related ore price escalation rate on the overall levelized fuel cycle cost of different scenarios are also considered. Finally, a comparative study of the various options is carried out.

## 3.2 Reactor Systems Analyzed

As mentioned before, one major objective of the present work involves consideration of the economic aspects of the thorium fuel cycle in LWRs. For the reasons enumerated by other investigators in this program (G-1), (C-2), the Maine Yankee PWR was selected as the representative reactor in their work, thus the same reactor was chosen here to permit use of the data obtained in these other studies for the economic calculations in the present work. The Maine Yankee reactor is a 2440 MWTh PWR reactor, designed



by C-E; it is operated by the Yankee Atomic Electric Co. Core parameters of this reactor are shown in Table (3-1), (M-1) and (G-1).

To examine the economic aspects of the thorium cycle, it is necessary to consider the ways that fissile material can be provided for this cycle.  $^{232}\text{Th}$  after absorption of one neutron (and two  $\beta^{-1}$  decays) transmutes into the fissile material  $^{233}\text{U}$ , which can provide some part of the fissile material required. Since  $^{233}\text{U}$  does not exist in nature, operation of some other fuel cycle must be considered to produce this fissile material for the  $^{233}\text{U}/^{232}\text{Th}$  cycle.  $^{235}\text{U}$  is the only fissile material existing in nature, and hence a  $^{235}\text{U}/^{232}\text{Th}$  system can be used to provide  $^{233}\text{U}$  for the  $^{233}\text{U}/^{232}\text{Th}$  cycle. However, the fissile  $^{233}\text{U}$  produced by  $^{235}\text{U}/\text{Th}$  units can be considered either to be mixed with residual  $^{235}\text{U}$ , or it can be assumed be kept segregated from the  $^{235}\text{U}$ . In the first case (non-segregated), the fuel charged to the  $^{233}\text{U}/\text{Th}$  units is a mixture of  $^{235}\text{U}$  and  $^{233}\text{U}$ . In the latter case, where it is possible to separate  $^{233}\text{U}$  from  $^{235}\text{U}$  (segregated: perhaps using pellets with two different regions, one containing the  $^{235}\text{U}$  and the other  $^{232}\text{Th}$ , or using  $^{235}\text{U}$  as a seed region and  $^{232}\text{Th}$  as a blanket), discharged  $^{235}\text{U}$  can be recycled to the  $^{235}\text{U}/\text{Th}$  units and  $^{233}\text{U}$  can be used to feed the  $^{233}\text{U}/^{232}\text{Th}$  units. Since in reference (G-1) the segregated case has been considered, in this report we will also deal with the problem in this way. However, later in this chapter the non-segregated option will also be studied to reveal the difference between these two cases. Figures (3-1a) and (3-1b) show these two options.

Another alternative exists in the form of the  $^{239}\text{Pu}/^{232}\text{Th}$  cycle, which can also be employed to produce  $^{233}\text{U}$ , but then  $^{239}\text{Pu}$  itself has to be produced, using the  $^{235}\text{U}/^{238}\text{U}$  cycle, for example. In this case the

TABLE 3-1

## MAINE YANKEE CORE PARAMETERS

Core thermal power, MWth	2440
Nominal electric output, MW(e)	790
Nominal thermal efficiency (MW(e)/MWTH)	0.33
Fuel management	3 batch, mixed central zone
Equilibrium discharged burnup, MWD/MTHM	33000
Power density, kw/liter	75.2
Core heavy metal loading, MTU	87
Number of fuel assemblies	217
Fuel rod array	14 x 14
Number of active fuel rods	38192
Fuel rod pitch, inches	0.58
Total length of fuel rod, inches	145.4
Active length of fuel rod, inches	137.0
Fuel material (sintered pellet)	UO <sub>2</sub>
Clad material	Zy-4
Clad ID, inches	0.388
Clad OD, inches	0.440
Clad thickness, inch	0.026
UO <sub>2</sub> /H <sub>2</sub> O volume ratio $V_f/V_m$	
Supercell	0.4816
Unit cell	0.621

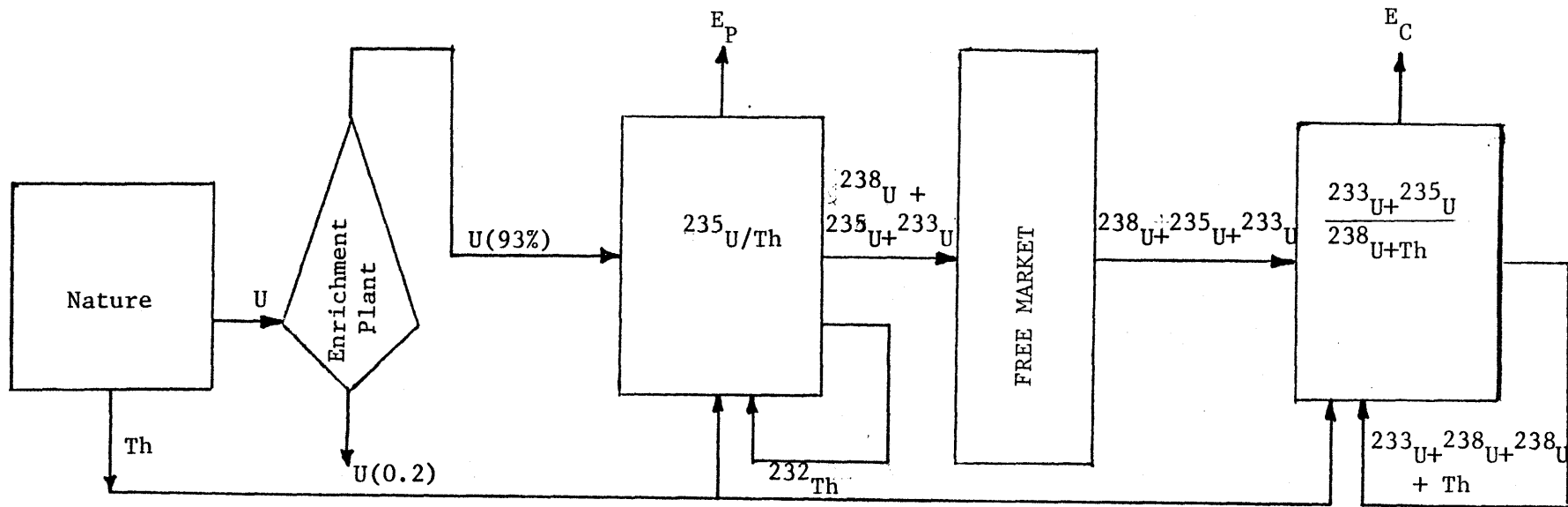

a - NON-SEGREGATED\*

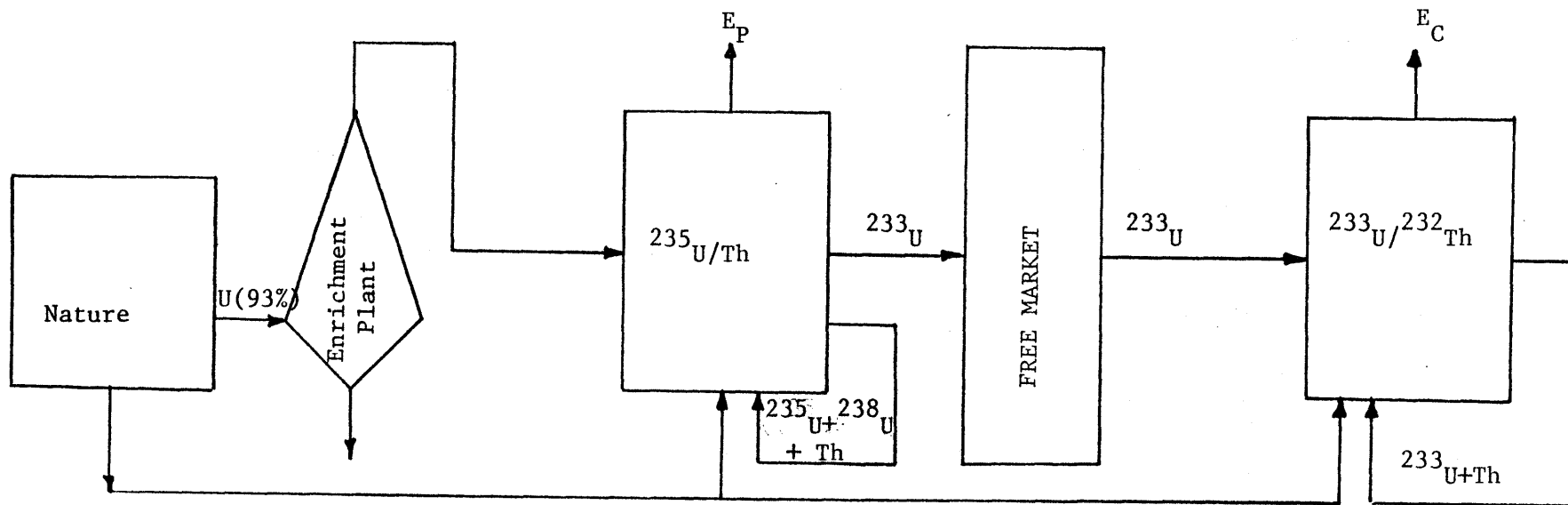

b. SEGREGATED\*

\*Discharge fissile Pu from  $^{235}\text{U}/\text{Th}$  was ignored and not shown

Figure 3-1  $^{235}\text{U}/\text{Th}$  Units Coupled with  $^{233}\text{U}/\text{Th}$  Unit for a. Non-Segregated and b. Segregated Cases

coupled cycles  $^{235}\text{U}/^{238}\text{U}(^{239}\text{Pu})$   $^{239}\text{Pu}/^{232}\text{Th}(^{233}\text{U})$ ,  $^{233}\text{U}/^{232}\text{Th}(^{233}\text{U})$  must be considered concurrently as shown in Figure (3-2). Note that in this case the discharged fissile materials from each reactor can be segregated from each other easily by chemical processing. However, in this report only the  $^{235}\text{U}/\text{Th}$ ;  $^{233}\text{U}/\text{Th}$  combination is considered in the economic analysis of the  $^{233}\text{U}/^{232}\text{Th}$  cycle. For comparison, the economic aspects of a  $^{235}\text{U}/^{238}\text{U}(^{239}\text{Pu})$  cycle coupled with a  $^{239}\text{Pu}/^{238}\text{U}(^{239}\text{Pu})$  cycle, as shown in Figure (3-3), is also studied. Finally, in view of current US policy,  $^{235}\text{U}/^{238}\text{U}$  with no recycle (the once-through cycle) is also considered. Note that in the recycling mode, the uranium is recycled to the producer reactor for all cases (except non-segregated  $^{235}\text{U}/\text{U}$ ;  $^{233}\text{U}/\text{Th}$ ) as shown in Figures (3-1) through (3-3). Consideration of recycled uranium is important especially for the segregated  $^{235}\text{U}/\text{Th}$  cycle, since in this case the weight per cent of feed enrichment is 93%, and thus the discharged fuel has a high  $^{235}\text{U}$  enrichment (about 45%).

The optimization of these cycles from the point view of ore usage has been carried out by K. Garel and M. J. Driscoll (G-1). Their results show that the ore and SWU requirements are insensitive to fuel pin diameter (at constant fuel-to-moderator volume ratio ( $V_f/V_m$ )). Since ore and SWU cost contribute on the order of 70% of the overall fuel cycle cost, in the present work we will fix the pin diameter and vary only the  $V_f/V_m$  ratio in order to find the minimum fuel cycle cost of the system of coupled reactors. It should be noted that for this analysis we use both types of fuel cycle (uranium and thorium cycles) in the same type of reactor. Thus linear heat generation rate, fuel pin heat flux and volumetric power density are the same; but since the thorium has a lower density, the specific power (kw/kg) for the thorium cycle is greater than for the uranium cycle.

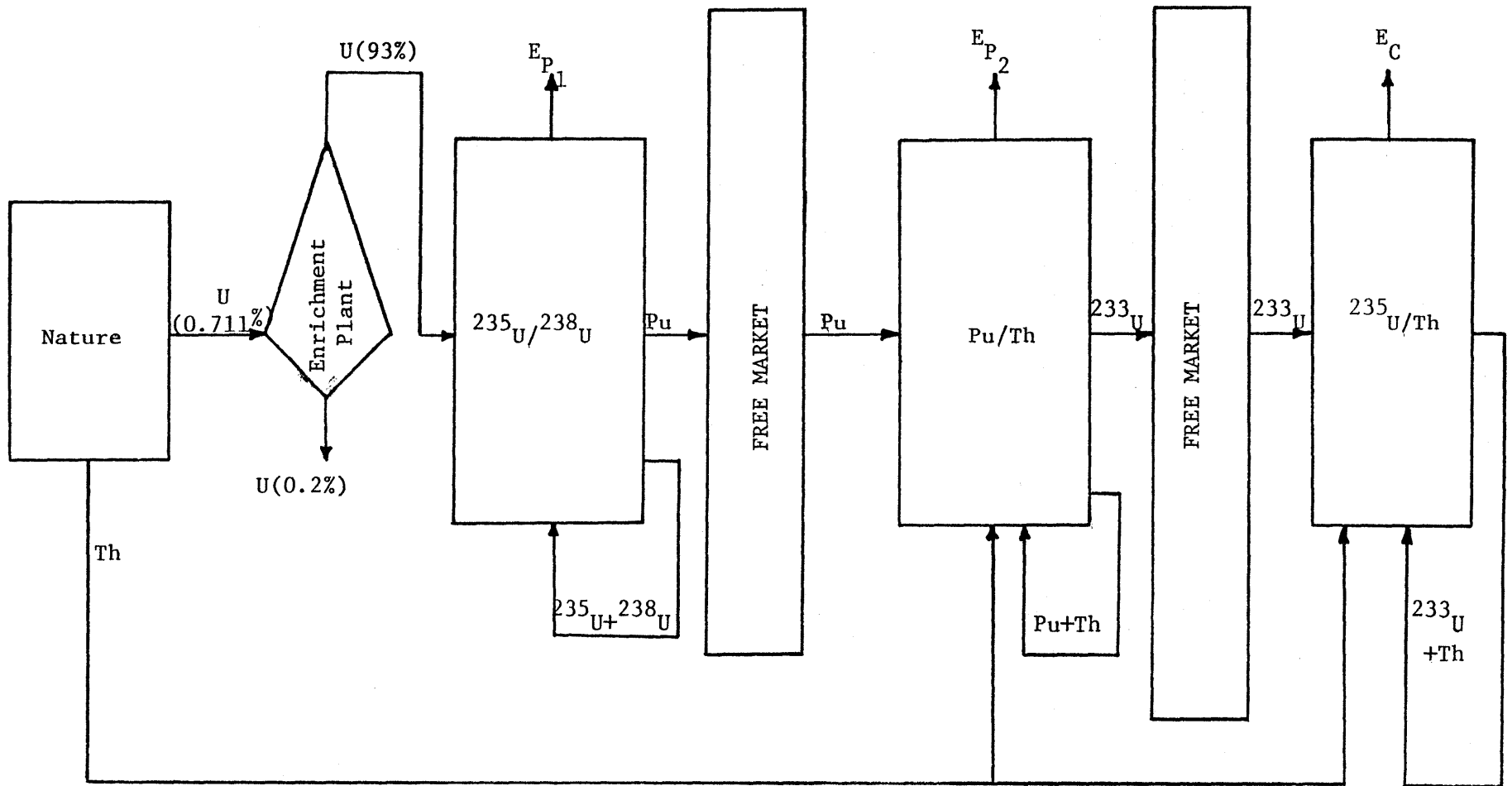

Figure 3.2 A  $^{235}U/^{238}U$  Cycle Coupled with the  $^{239}Pu/^{232}Th$  Cycle to Produce  $^{233}U$   
for a  $^{233}U/^{232}Th$  Cycle

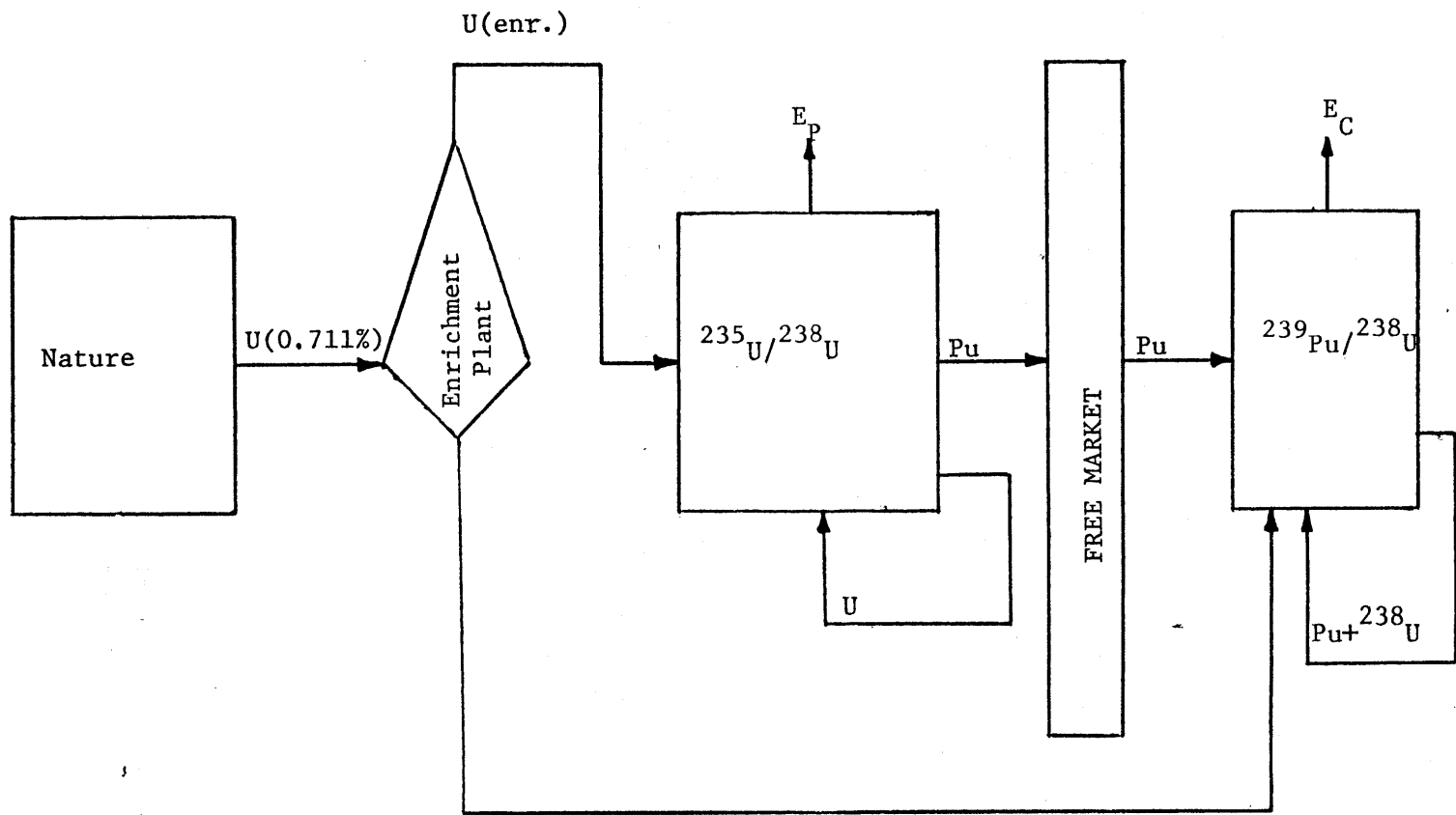

Figure 3.3 A  $^{235}\text{U}/^{238}\text{U}$  Cycle Coupled with the  $^{239}\text{Pu}/^{238}\text{U}$  Cycle

### 3.3 Optimization of Fuel Cycle Cost

#### 3.3.1 Effect of Fuel-to-Moderator Volume Ratio

In this section the physics effects of varying the fuel-to-moderator volume ratio,  $V_f/V_m$ , will be briefly discussed. Increasing  $V_f/V_m$  means less moderation, which results in a harder neutron spectrum in the core. Reduced moderator content and a harder spectrum both lead to a decrease in the parasitic absorption in the core, and an increase in the conversion ratio, since more neutrons are available for capture in fertile material (even though increasing the neutron energy also causes the neutron yield per absorption,  $\eta$ , to decrease slightly). However, the decreased magnitude of the spectrum averaged fissile absorption cross sections also lead to an increase in fissile inventory. Thus there are two opposing effects: high conversion and high inventory. At some  $V_f/V_m$  these two effects trade off against each other to give a minimum fuel cycle cost for the system of coupled reactors. Determination of this minimum point is the subject of the next section.

#### 3.3.2 The Indifference Value of Fissile Material

The goal of this section is to introduce the method used to determine the value of fissile plutonium and  $^{233}\text{U}$ . The unit price of  $^{235}\text{U}$  enriched uranium can be easily found since it can be defined in terms of ore price and SWU cost as:

$$C_{\text{U-5}}(\epsilon) = C_{\text{SWU}} \frac{S}{P} + C_{\text{U}_3\text{O}_8} \frac{F}{P}, \frac{\$}{\text{Kg}} \quad (3.1)$$

where

$C_{U-5}$  = cost of  $^{235}\text{U}$  enriched uranium fed to reactor, \$/Kg

$C_{\text{U}_3\text{O}_8}$  = cost of natural  $\text{U}_3\text{O}_8$ , \$/lb

$C_{\text{SWU}}$  = cost of separative work, \$/Kg SWU

F/P = lbs of  $\text{U}_3\text{O}_8$  feed per Kg of enriched uranium fed to reactor

S/P = separative work units required per Kg of enriched product

$\epsilon$  = weight fraction of  $^{235}\text{U}$  in uranium fed to reactor

If we assume the tail's assay to be 0.2% w/o, then

$$F/P = 431.51 (\epsilon - 0.002) \quad (3.2)$$

$$\frac{S}{P} = (2\epsilon - 1) \ln \frac{\epsilon}{1 - \epsilon} + 258.1\epsilon - 6.704 \quad (3.3)$$

For 93% enrichment, from the above equations:

$$C_{U-5}(0.93) = 0.400 C_{\text{U}_3\text{O}_8} + 0.236 C_{\text{SWU}}, \text{ $/gr} \quad (3.4)$$

on the basis of the unit prices in Table (3-2)

$$C_{U-5} = 38.2 \text{ $/gr}$$

For determination of fissile plutonium and  $^{233}\text{U}$  values we must consider the use of reactors to irradiate  $^{238}\text{U}$  and  $^{232}\text{Th}$ , respectively, using the  $^{235}\text{U}/^{238}\text{U}$  and  $^{235}\text{U}/^{232}\text{Th}$  fuel cycles. (Other methods such as fusion or accelerator-driven breeding blankets are conceptually possible but far from commercially proven). Thus the prices of these fissile materials depend on the value of  $^{235}\text{U}$ , or in other words, on the value of ore and SWU.



To determine this relationship two LWRs will be considered: one producing fissile material (the producer reactor) and the other consuming it (the consumer reactor). As the price of fissile material increases, the producer reactor earns more credits as the result of the sale of fissile material and thus its power cost will decrease. On the other hand an increase in the unit price of fissile material will increase the power cost of the consumer reactor. Figure (3-4) illustrates the above relationship. As shown in this figure, at same price,  $C_0$ , the power cost of the producer reactor and the consumer reactor become equal ( $e_0$ ). If the price of fissile material is less than  $C_0$ , that is,  $C_1$ , then the power cost of the consumer reactor ( $e_{c1}$ ) is less than the power cost of the producer reactor ( $e_{p1}$ ), which will encourage the installation of more consumer type reactor cores, which will result in a greater demand for fissile material, and consequently an increase in the price of fissile material. If the price of fissile material is increased above  $C_0$  to  $C_h$ , the power cost of the producer reactor ( $e_{ph}$ ) is now less than that of the consumer reactor ( $e_{ch}$ ) and therefore a producer-type reactor is more favorable for production of electricity. Therefore the demand for fissile material will decrease and force the unit price of fissile material to go down. Thus the unit price  $C_0$  will give us an equilibrium condition, where consumer and producer reactors are equally advantageous. Thus unit price is called the "indifference" value of fissile material - that value which will result in an equal power cost for consumer and producer reactors. In the present work a less general interpretation is appropriate. Since we are dealing with different core designs used in reactors, which are otherwise similar, the preceding discussion can be modified to consider only fuel cycle cost, rather than total busbar cost (which would be appropriate for coupled LWR-LMFBR

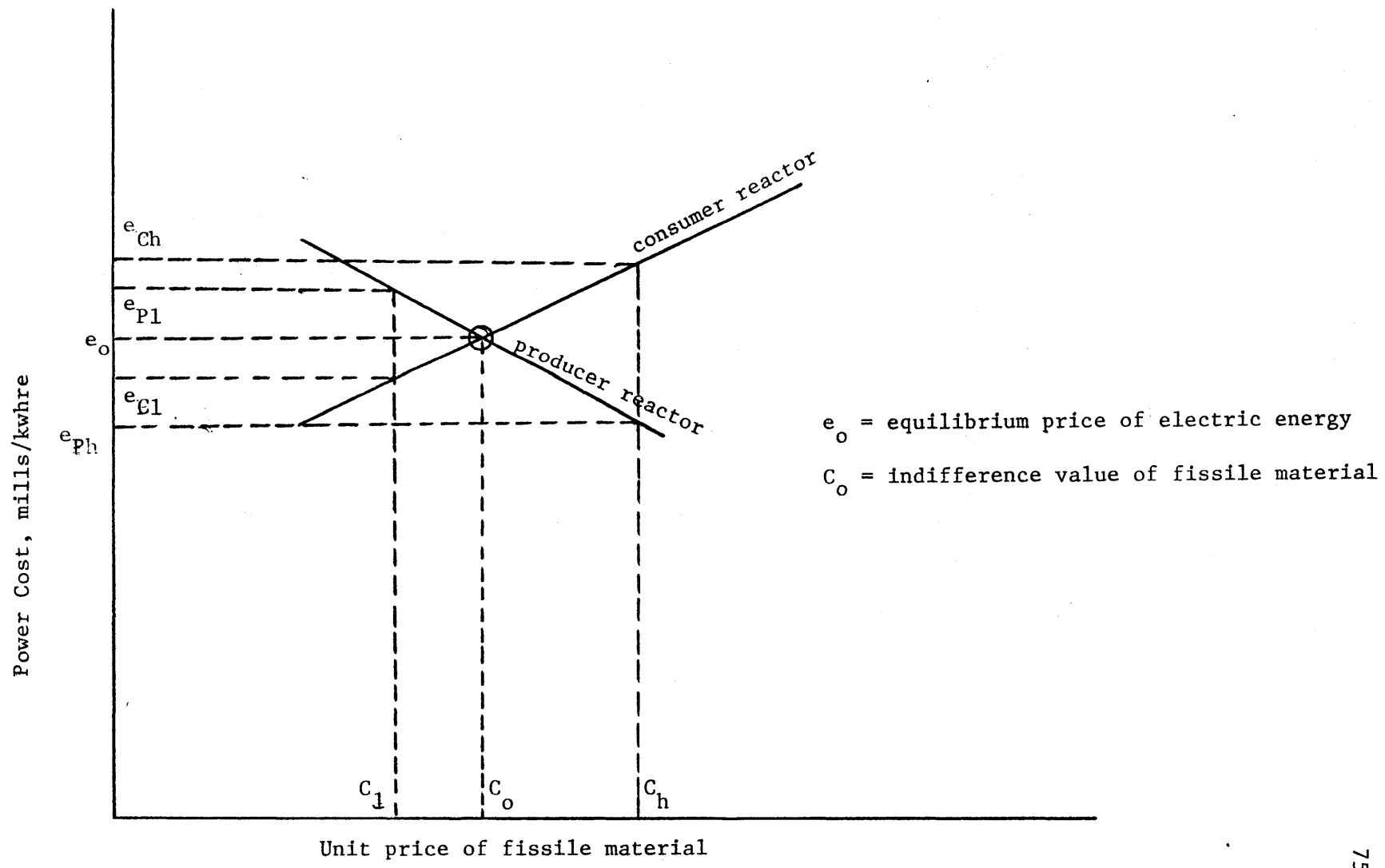

Figure 3.4 Power Cost of Producer and Consumer Reactors as a Function of the Unit Price of Fissile Material

scenarios, for instance). On the basis of this definition, the relationship of the unit price of fissile materials to ore and SWU costs can be obtained. This correlation will be developed later.

### 3.3.3 $^{235}\text{U}/^{238}\text{U}$ coupled with $\text{Pu}/^{238}\text{U}$

For these coupled cycles, a reactor on the uranium cycle (with uranium recycle) is used to produce plutonium for a reactor which consumes plutonium on the  $\text{Pu}/^{238}\text{U}$  cycle (Figure 3-3). While a single reactor may not generate enough plutonium to fuel a consumer reactor of equal rating, we will analyze equally-rated systems on the assumption that a large number of both types of reactors are engaged in a free market exchange of plutonium. As Garel also notes (G-1), in most instances there is little difference whether plutonium is recycled in a separate reactor or in separate assemblies within the producer reactor - hence one may wish to think of the coupled systems as being in this self-generated recycle mode. We will, however, also treat cases in which the consumer and producer have different  $V_f/V_m$  values, which would probably be impractical in the same core.

Tables (D-1) and (D-2) in Appendix D show the mass flows charged and discharged for the  $^{235}\text{U}/^{238}\text{U}$  and  $\text{Pu}/^{238}\text{U}$  cycles, respectively, for different fuel-to-moderator volume ratios. Table (3-2) shows the unit prices and economic parameters which have been used to calculate the overall levelized fuel cycle cost for this study. The unit prices given in this table are from the recent study by the Atomic Industrial Forum (A-2), except for the fabrication cost, reprocessing cost and waste disposal cost (for the reasons explained in the next section). In reference (A-2) an arithmetic average for each step of the fuel cycle was

TABLE 3-2  
UNIT PRICES AND ECONOMIC DATA <sup>(1)</sup> FOR COUPLED FUEL CYCLES

<u>TRANSACTION</u>	<u>UNITS</u>	<u>VALUE</u> <sup>(2)</sup>
Ore Cost ( $U_3O_8$ )	\$/lb	40
Enrichment	\$/SWU	94
Spent Fuel Transportation	\$/Kg HM	17
UF <sub>6</sub> Conversion	\$/Kg HM	4.0
Fuel Fabrication		
$^{235}U/^{238}U$ (3)	\$/Kg HM	150
$^{235}U/^{232}Th$ (3)	\$/Kg HM	200
Pu/ $^{238}U$ (3)	\$/Kg HM	500
$^{233}U/^{232}Th$ (4)	\$/Kg HM	570
Reprocessing		
$^{235}U/^{238}U$ (3)	\$/Kg HM	221
$^{235}U/^{232}Th$ (3)	\$/Kg HM	278
Pu/ $^{238}U$ (3)	\$/Kg HM	221
$^{233}U/^{232}Th$ (4)	\$/Kg HM	278
Waste Disposal		
$^{235}U/^{238}U$ (3)	\$/Kg HM	71
$^{235}U/^{232}Th$ (3)	\$/Kg HM	92
Pu/ $^{238}U$ (3)	\$/Kg HM	71
$^{233}U/^{232}Th$ (4)	\$/Kg HM	92
$^{232}Th$ Price <sup>(3)</sup>	\$/lb	15.0
$^{238}U$ Price	\$/lb	15.0

(1) From Ref. (A-2), otherwise as specified

(2) Values in terms of 1977 dollars

(3) Ref. (K-2)

(4) Ref. (A-3)

(table continued on next page)

TABLE 3-2

(continued)

Bond-holder fraction, $f_b$	0.5
Stock-holder fraction, $f_s$	0.5
Return to bond-holder (deflated), $r_b$	6%
Return to stock-holder (deflated), $r_s$	8%
Tax rate, $\tau$	50%
Discount rate (deflated), $x$	5.5%
$(x = (1 - \tau)f_b r_b + f_s r_s)$	
Scarcity-related escalation rate for ore	0.0%

calculated using base-case values from nine studies. The unit prices of  $^{239}\text{Pu}$  and  $^{233}\text{U}$  in the present work were then obtained using the concept of indifference value.

Tables (E-1) and (E-2) in Appendix E give the quantities involved in each step in the fuel cycle. These mass transactions were obtained using the equations introduced in Appendix E, under the assumptions which have been discussed there, and by using the mass flows charged and discharged in Tables (D-1) and (D-2) of Appendix D. Use of this information and the economic data from Table (3-2) in SIMMOD gives the overall levelized fuel cycle cost for a  $^{235}\text{U}/^{238}\text{U}$  fueled reactor coupled with a  $\text{Pu}/^{238}\text{U}$  fueled reactor corresponding to the indifference value of fissile plutonium.

Figure (3-5) shows the overall levelized fuel cycle costs of the  $^{235}\text{U}/^{238}\text{U}$  system (producer) and the  $\text{Pu}/^{238}\text{U}$  unit (consumer) as a function of the unit price of fissile plutonium for different fuel-to-moderator volume ratios. The intersection of one producer reactor line and one consumer reactor line gives the overall levelized fuel cost of these coupled fuel cycles. Since four different  $V_f/V_m$  values have been considered for both consumer and producer reactors, sixteen different combinations of producer and consumer reactors are possible. Table (3-3) shows the overall levelized fuel cycle cost of  $^{235}\text{U}/^{238}\text{U}$  units coupled with the  $\text{Pu}/^{238}\text{U}$  units for different combinations of  $V_f/V_m$  for producer and consumer reactors. Figure (3-6) shows the overall levelized fuel cycle cost as a function of fuel-to-moderator volume ratio in the case where both producer and consumer reactors have the same  $V_f/V_m$ , and also where  $V_f/V_m$  for the producer reactor is fixed at 0.4816. As can be seen from this figure, when both producer and consumer reactor have the same  $V_f/V_m$  the minimum fuel cycle cost is at a fuel-to-moderator volume ratio of about 0.5 (6.18 mills/kwhre), which corresponds to

TABLE 3-3  
 OVERALL LEVELIZED FUEL CYCLE COST OF  $^{235}\text{U}/^{238}\text{U}$  UNITS  
 COUPLED WITH  $\text{Pu}/^{238}\text{U}$  UNITS

$V_f/V_m$ Producer $^{235}\text{U}/^{238}\text{U}$	$V_f/V_m$ Consumer $\text{Pu}/^{238}\text{U}$	$\bar{e}_o$ overall levelized fuel cycle cost (mills/kwhr)	Ore Requirement* $\text{ST U}_3\text{O}_8/\text{GWe, yr}$
0.338	0.338	6.60	130.53
0.338	0.4816	6.58	126.02
0.338	0.9161	6.80	137.11
0.338	1.496	6.81	137.53
0.4816	0.338	6.21	114.63
0.4816	0.4816	<u>6.19</u>	110.17
0.4816	0.9161	6.40	121.99
0.4816	1.496	6.42	122.45
0.9161	0.338	7.30	105.56
0.9161	0.4816	7.20	<u>99.45</u>
0.9161	0.9161	7.79	116.18
0.9161	1.496	7.81	116.88
1.496	0.338	9.30	111.18
1.496	0.4816	9.20	103.36
1.496	0.9161	10.35	125.30
1.496	1.496	10.40	126.25

\*For zero system growth rate and 0.2% tail assay of separation plant

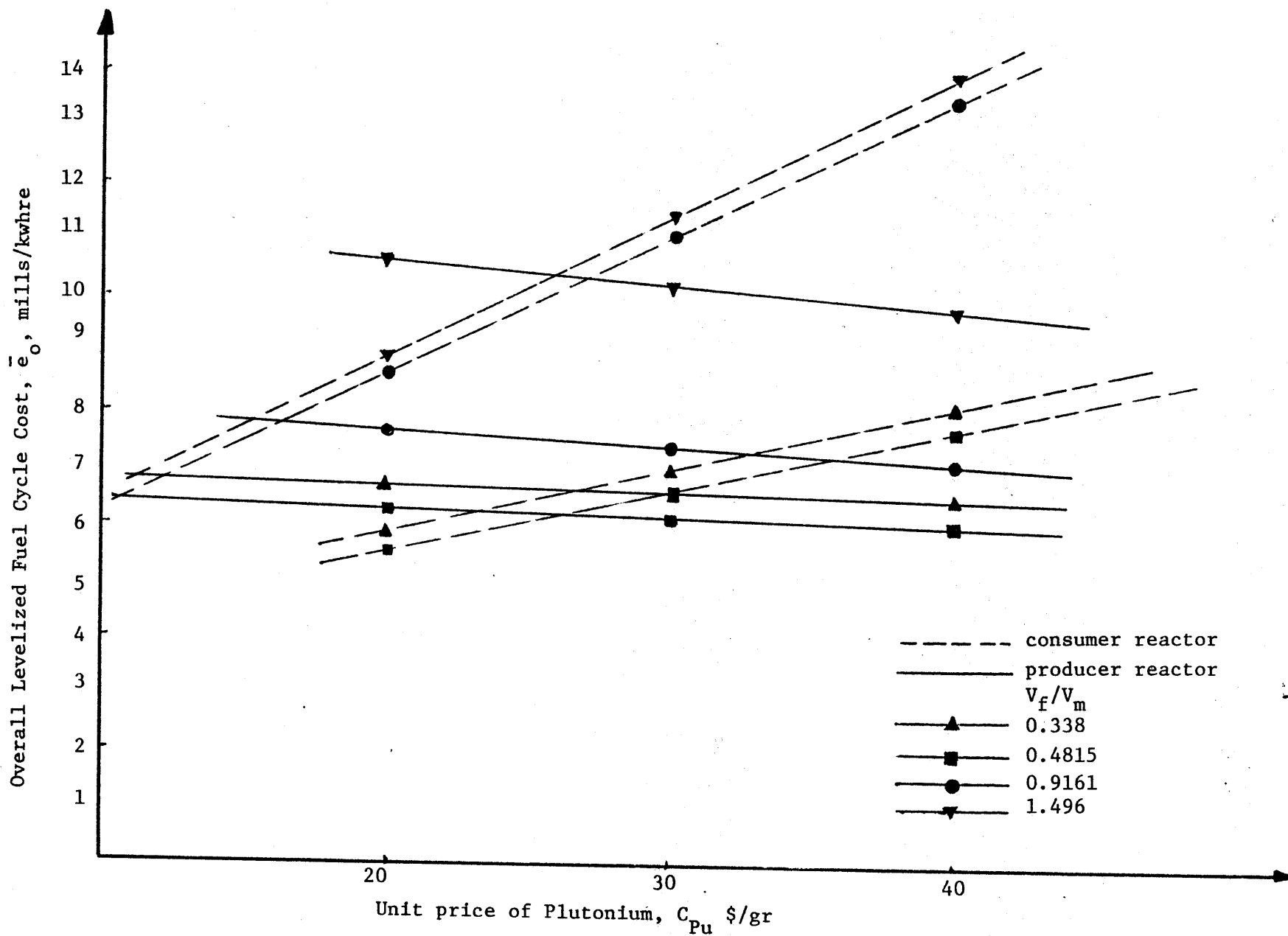

Figure 3.5 Overall Levelized Fuel Cycle Cost versus Unit Price of Fissile Plutonium for  $^{235}\text{U}/^{238}\text{U}$  and  $\text{Pu}/^{238}\text{U}$  Cycles



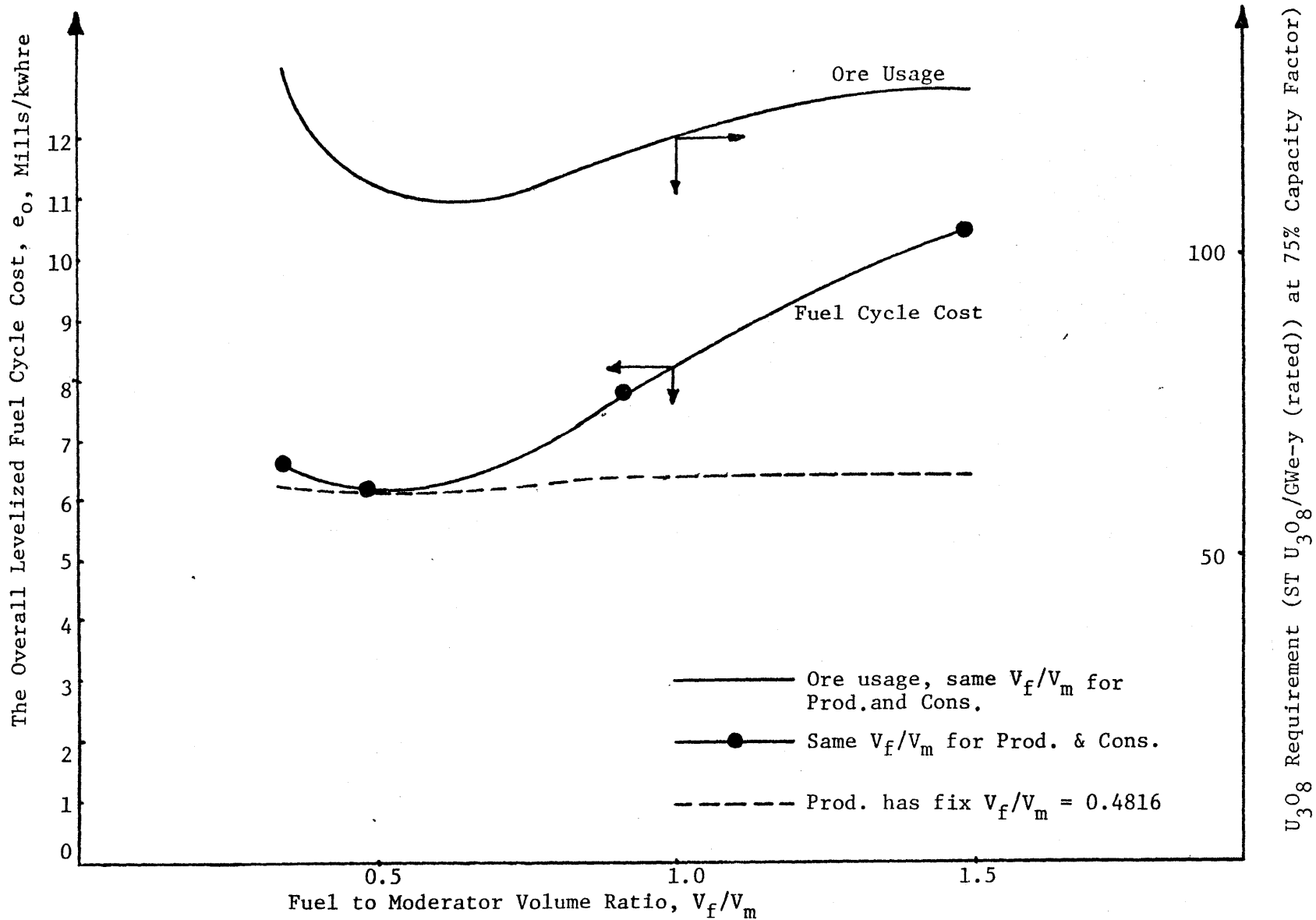

Figure 3.6 Overall Levelized Fuel Cycle Cost and Ore Requirement as a Function of Fuel to Moderator Volume Ratio for Coupled  $^{235}\text{U}/^{238}\text{U}$  and  $\text{Pu}/^{238}\text{U}$  Cycles

current LWR designs (e.g. Maine Yankee has  $V_f/V_m = 0.4816$ ). If the  $V_f/V_m$  of the producer reactor is kept constant, the overall levelized fuel cycle cost is insensitive to variation of the fuel-to-moderator volume ratio of the consumer reactor, as can be seen in Table (3-3); also, Figure (3-6) shows the fuel cycle cost where the producer reactor has a fixed  $V_f/V_m$  equal to 0.4816. As a result, it can be concluded that when both producer and consumer reactor have a  $V_f/V_m$  of about 0.5, the overall levelized fuel cycle cost of  $^{235}\text{U}/^{238}\text{U}$  units coupled to  $\text{Pu}/^{238}\text{U}$  units is a minimum. To compare the fuel cycle cost with the ore usage, the ore usage model described in reference (G-1) was employed to determine the ore requirement for each case as shown in Table (3-3) and Figure (3-6). As can be seen, the fuel cycle cost and ore requirement curves have similar shapes (as expected, since ore cost is the dominant component of the fuel cycle cost balance). This figure shows that the minimum in the overall levelized fuel cycle cost occurs at a lower  $V_f/V_m$  than the minimum in ore usage, therefore there is no economic incentive to use tight-pitch lattices for these coupled cycles. In reference (G-1) it was also found that the ore requirement was optimized when the producer reactor and the consumer reactor had a  $V_f/V_m$  equal to 0.9161 and 0.4816, respectively (see Table (3-3)). But, to reiterate investigation of Table (3-3) shows that the fuel cycle cost is optimized when both producer and consumer reactor have a  $V_f/V_m$  equal to 0.4816.

### 3.3.4 $^{235}\text{U}$ (93%)/ $^{232}\text{Th}$ Reactors Coupled with $^{233}\text{U}/^{232}\text{Th}$ Reactors (Segregated Case)

This coupled cycle consists of a producer reactor which uses  $^{235}\text{U}$  (93%) as its fissile material and  $^{232}\text{Th}$  as its fertile material to produce energy and  $^{233}\text{U}$ . The consumer reactor uses the  $^{233}\text{U}/^{232}\text{Th}$  cycle, and consumes  $^{233}\text{U}$  which has been produced by the producer reactor. As before, simultaneous operation of the consumer and producer reactors is assumed, which implies a large-scale market in fissile materials. Tables (D-3) and (D-4) in Appendix D show the mass flows charged and discharged for the  $^{235}\text{U}$  (93%)/ $^{232}\text{Th}$  and  $^{233}\text{U}/^{232}\text{Th}$  units, respectively. The unit prices and economic parameters given in Table (3-2) are also employed here. It should be noted that there is considerable uncertainty in regard to the fabrication cost and reprocessing cost for the  $^{233}\text{U}/^{232}\text{Th}$  cycle. Kasten et. al. (K-2) have estimated the unit prices for these steps for different types of fuel cycles. The recent study by Abtahi (A-3) gives a higher value (by a factor of 1.3) for the fabrication and waste disposal cost in the  $^{233}\text{U}/^{232}\text{Th}$  cycle. These values were selected for use in the current study. For the other fuel cycles the unit prices estimated by Kasten have been used for these steps. A study by the Atomic Industrial Forum (A-2) gives a reference value of 99 \$/kg HM for the  $\text{UO}_2$  fuel fabrication cost, and a highest price of 134 \$/Kg HM. But as can be seen in Table (3-2), a value of 150 \$/Kg HM has been chosen from Reference (K-2), which is greater than the highest value in Reference (A-2). Although 99 \$/Kg HM is in line with the current price of fuel fabrication for the  $^{235}\text{U}/^{238}\text{U}$  cycle, the values for Reference (K-2) are selected to insure a valid cycle-to-cycle comparison. The same reasoning was applied in the case of reprocessing and waste disposal costs, and thus the values given in Table (3-2) are used for present economic calculations.

Using the data in Tables (D-1) and (D-2), and the equations given in Appendix E, one can find the transaction quantities for each step in the fuel cycle, as tabulated in Tables (E-3) and (E-4) of Appendix E. Note that for  $^{235}\text{U}/\text{Th}$  units, discharged Pu was ignored, since the weight per cent of  $^{238}\text{U}$  in charged fuel is very small (7% of charged uranium) and thus the production of fissile plutonium is very low (there are, in addition, some other assumptions, which are discussed in Appendix E).

Using these data and the economic information in Table (2-3) one can find the overall levelized fuel cycle cost of this coupled system of reactors corresponding to the indifference value of  $^{233}\text{U}$ .

Figure (3-7) shows the overall levelized fuel cycle cost of the  $^{235}\text{U}/^{232}\text{Th}$  (producer) reactor and the  $^{233}\text{U}/^{232}\text{Th}$  (consumer) reactor versus the unit price of  $^{233}\text{U}$ . Following the discussion outlined in Section 3.3.2, the intersection of producer reactor and consumer reactor traces gives the overall levelized fuel cycle cost of the coupled system. Figure (3-8) shows the overall levelized fuel cycle cost of a  $^{235}\text{U}/^{232}\text{Th}$  unit coupled with a  $^{233}\text{U}/^{232}\text{Th}$  unit, as a function of fuel-to-moderator volume ratio. Table (3-4) gives the overall levelized fuel cycle cost at the indifference value of  $^{233}\text{U}$  for different combinations of producer and consumer reactors. From Figure (3-8) and Table (3-4) it can be concluded that when both producer and consumer reactor have the same  $V_f/V_m$  the minimum overall levelized fuel cycle cost is at  $V_f/V_m$  equal to roughly 0.6. Also, it can be seen from Table (3-4) that (except for  $V_f/V_m$  equal to 1.496 for the producer reactor) most combinations have almost the same overall levelized fuel cycle cost. However, as can be seen from Table (3.4) (also see Figure 3-8) when the producer reactor has a fixed fuel-to-moderator volume ratio of 0.4861, the overall levelized fuel

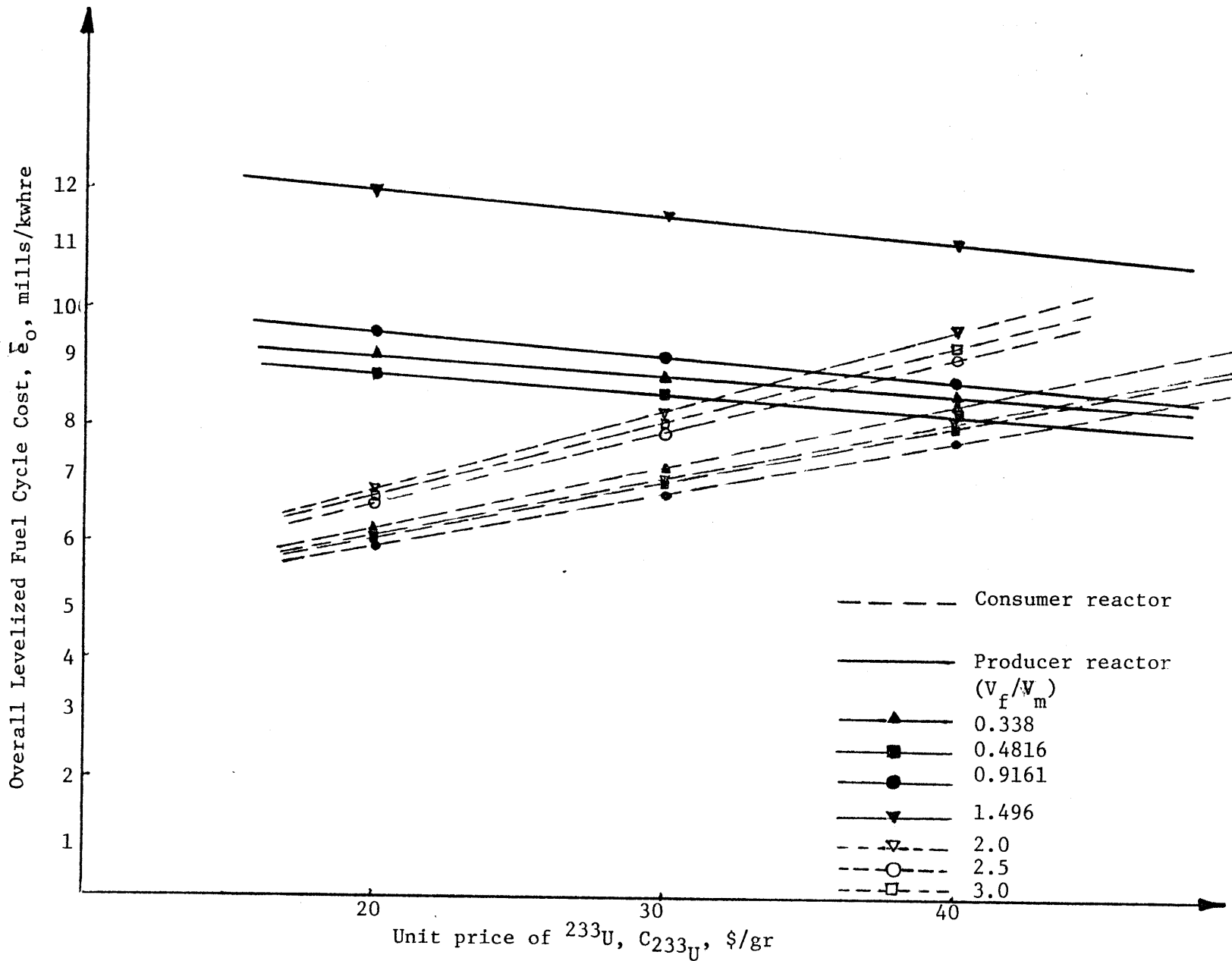

Figure 3.7 Overall Levelized Fuel Cycle Cost of  $^{235}\text{U}/^{232}\text{Th}$  and  $^{233}\text{U}/^{232}\text{Th}$  Fueled Reactors as a Function of the Unit Price of  $^{233}\text{U}$

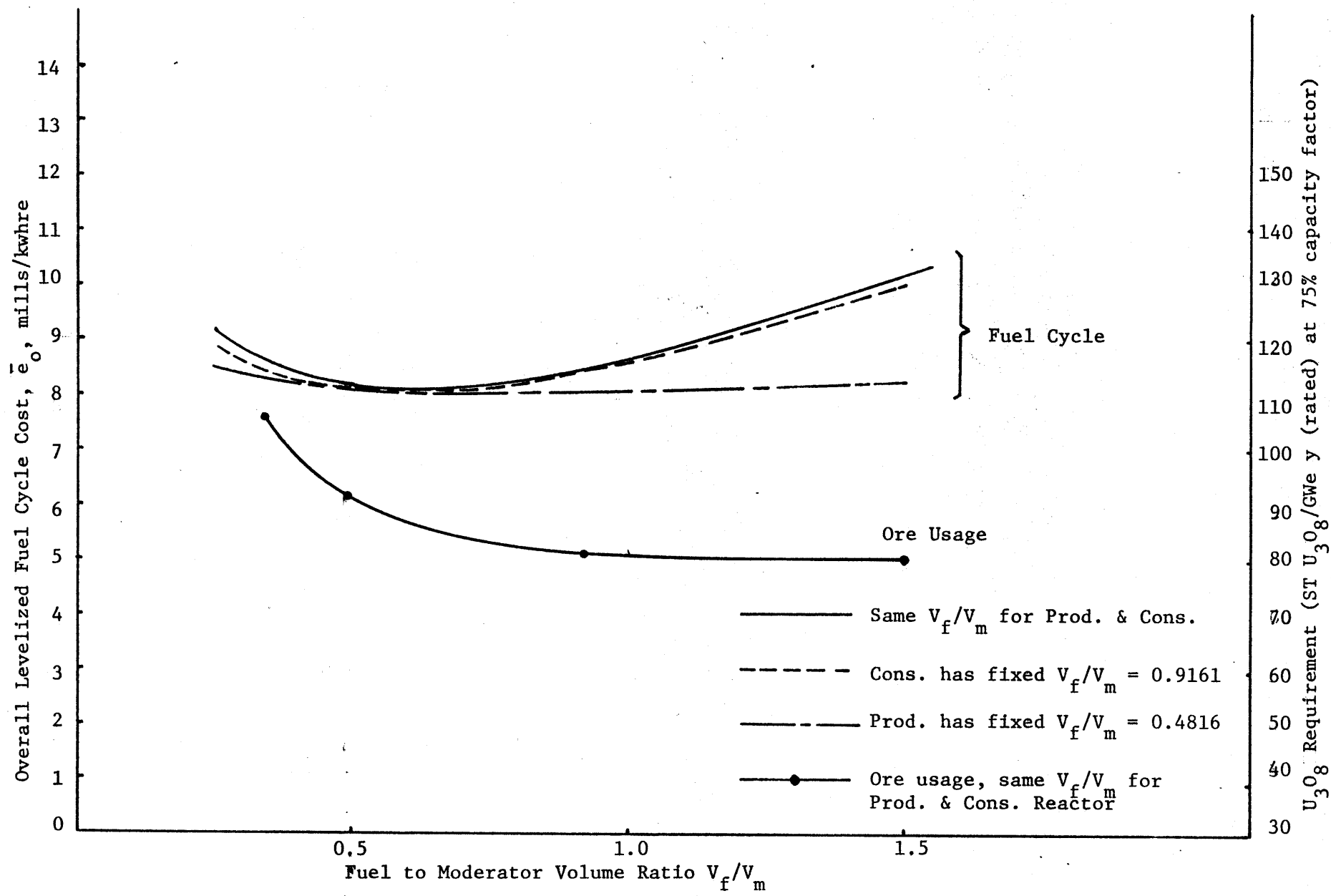

Figure 3.8 The Overall Levelized Fuel Cycle Cost and Ore Requirement as a Function of  $V_f/V_m$  for Coupled  $^{235}\text{U}/\text{Th}$  (segregated) and  $^{233}\text{U}/\text{Th}$  Cycles

TABLE 3-4  
 OVERALL LEVELIZED FUEL CYCLE COST OF  $^{235}\text{U}(93\%)/^{232}\text{Th}$  REACTORS  
 COUPLED WITH  $^{233}\text{U}/^{232}\text{Th}$  REACTORS

$V_f/V_m$ Producer $^{235}\text{U}(93\%)/^{232}\text{Th}$	$V_f/V_m$ Consumer $^{233}\text{U}/^{232}\text{Th}$	$\bar{e}_o$ Overall Levelized Fuel Cycle Cost (mills/kwhre)	Ore Requirement* ST $\text{U}_3\text{O}_8/\text{GWe}/\text{yr}$
0.338	0.338	8.50	105.32
0.338	0.4816	8.40	97.23
0.338	0.9161	8.33	89.36
0.338	1.496	8.42	84.98
0.4816	0.338	8.23	98.32
0.4816	0.4816	8.10	90.53
0.4816	0.9161	<u>8.06</u>	82.99
0.4816	1.496	8.13	78.80
0.9161	0.338	8.64	95.90
0.9161	0.4816	8.53	87.83
0.9161	0.9161	8.44	80.12
0.9161	1.496	8.66	<u>75.85</u>
1.496	0.338	10.3	101.51
1.496	0.4816	10.1	92.45
1.496	0.9161	10.0	83.87
1.496	1.496	10.1	79.20

\*For 0%/yr system growth rate and 0.2% tail assay of separation plant

cycle cost is lower for any consumer reactor  $V_f/V_m$ ; and where the consumer reactor has a fuel-to-coolant volume ratio of 0.9161, the overall levelized fuel cycle cost is the minimum. Figure (3-8) and Table (3-4) also show the ore requirements as a function of fuel-to-moderator volume ratio (both producer and consumer have the same volume ratio). The ore usage curve shows that as the fuel - to - moderator volume ratio increases the ore requirement for this coupled cycle will decrease, even though, as can be seen from Figure (3-8) and Table (3-4) the overall levelized fuel cycle cost (for  $V_f/V_m$  greater than 0.6) will increase. This difference can be explained readily by investigation of Table (3-5). This table shows ore requirements, separative work requirements, and the corresponding contribution to fuel cycle costs for these two steps for the  $^{235}\text{U}(93\%)/^{232}\text{Th}$  cycle for different  $V_f/V_m$ . As can be seen from this table, the contribution of enrichment charges to fuel cycle cost is greater than that for ore requirements for all  $V_f/V_m$ , and the margin becomes more pronounced as  $V_f/V_m$  increases. Thus the effect of SWU requirements on the economics of this coupled fuel cycle is very important in that it causes the overall levelized fuel cycle cost to increase for high  $V_f/V_m$ . Also, Table (3-4) shows that the minimum ore requirement occurs when the producer and consumer reactors have  $V_f/V_m$  equal to 0.9161 and 1.496, respectively, whereas, as mentioned above, the minimum fuel cycle cost is at  $V_f/V_m$  equal to 0.4816 for the producer reactor and 0.9161 for the consumer reactor. For this reason using tight-lattice cores for producer reactors is not attractive, since it causes the overall levelized fuel cycle cost to increase. However (similar to  $^{235}\text{U}/\text{U}$  units coupled with  $\text{Pu}/\text{U}$  units), using a producer reactor with fixed  $V_f/V_m$  causes the overall levelized fuel cycle cost to be insensitive to variation in the  $V_f/V_m$  of the consumer



TABLE 3-5

ORE AND SWU REQUIREMENTS FOR THE  $^{235}\text{U}$  (93%)/ $^{232}\text{Th}$  CYCLE

$V_f/V_m$	ORE Requirement lb $\text{U}_3\text{O}_8$ /Batch	SWU Requirement kg SWU/Batch	$e_{\text{ORE}}^*$ mills/kwhre	$e_{\text{SWU}}^{**}$ mills/kwhre
0.338	510,980	252,375	4.21	4.66
0.4816	493,822	243,886	4.07	4.50
0.9161	578,104	285,512	4.76	5.27
1.497	836,073	412,915	6.89	7.63

\*40 \$/lb  $\text{U}_3\text{O}_8$ 

\*\*94 \$/kg SWU

reactors. This claim can be readily explained by investigation of Figures (3-5) and (3-7). Since the credit from sale of the fissile material is a small fraction of overall levelized fuel cycle cost of the producer reactors, its fuel cycle cost does not change very much with variation of the unit cost of fissile material. Therefore the trace of the fuel cycle cost function versus the unit price of fissile material has a small slope for the producer reactor, hence the points of intersection with the traces of consumer reactor cost functions remain at nearly the same vertical height, which means that the fuel cycle cost is relatively insensitive to variation of  $V_f/V_m$  in the consumer reactor. Hence, if the  $V_f/V_m$  of the producer reactor is fixed at constant  $V_f/V_m$ , the  $V_f/V_m$  for the consumer reactor (Pu/U or  $^{235}\text{U}/\text{Th}$ ) can within limits be chosen to satisfy other objectives such as minimizing fissile inventory, make up needs, or facilitating core physics and safety design.

Work is currently underway by investigators at MIT on very tight pitch (high  $V_f/V_m$ ) lattices of  $^{233}\text{U}/^{232}\text{Th}$  fueled reactors (C-2). Therefore fuel-to-moderator volume ratios were increased beyond those considered in Figure (3-8) to examine the effect of large  $V_f/V_m$  value on the overall levelized fuel cycle cost. Since it was shown that the overall levelized fuel cycle cost has the lowest value for a producer reactor  $V_f/V_m$  equal to 0.4861, the  $V_f/V_m$  ratio of the producer reactor was held constant at this value. Table (D-5) gives the mass flows charged and discharged. The transaction quantities for each step in the fuel cycle are shown in Table (3-2). The overall levelized fuel cycle cost versus unit price of fissile material has been computed (the results are shown in Figure (3-7)). Using the  $^{233}\text{U}$  indifference prices computed in this manner, the overall levelized fuel cycle cost has been computed as a function of fuel-to-moderator volume ratio

and plotted in Figure (3-9). As can be seen from this figure even for ultra-tight lattice pitch in the consumer reactors, when the  $V_f/V_m$  ratio is equal to 0.4816 for the producer reactor the fuel cycle cost doesn't change very much, and it can be said that it is insensitive to variation of  $V_f/V_m$ .

It is appropriate, however, at this point to call attention to the fact that all of the preceding analyses were done at the same (zero) ore price escalation rate. Different ore use rates imply different ore price escalation rates - a refinement which will be considered later in this chapter.

### 3.3.5 The Once-Through Fuel Cycle

As mentioned before, the effect of varying the fuel-to-moderator volume ratio on the  $^{235}\text{U}/^{238}\text{U}$  fuel cycle cost with no recycle has been examined. Two limiting-cases have been considered. First spent fuel can be stored on site by the operator (and costs subsumed into plant capital and operating cost) in which case only disposal costs are charged to the fuel cycle; or the fuel can be shipped to an away-from-reactor storage facility and subsequently disposed of. Unit price estimates for each case have been published by DOE (D-2): 117\$/Kg HM in the case of "disposal only" and 233 \$/Kg HM in the case of "storage and disposal" (1978) dollars). Using a 6% inflation rate, these prices become 110 \$/Kg HM and 219 \$/Kg HM in 1977 dollars. Using these costs, and those given in Table (3-2) for the other steps in the fuel cycle, and employing the mass flow transactions given in Table (E-2), the overall levelized fuel cycle cost can be obtained for each  $V_f/V_m$ , as shown in Figure (3-10) and Table (3-6). The ore requirements are also given in Table (3-6) and depicted in Figure (3,10), As can be seen, for high

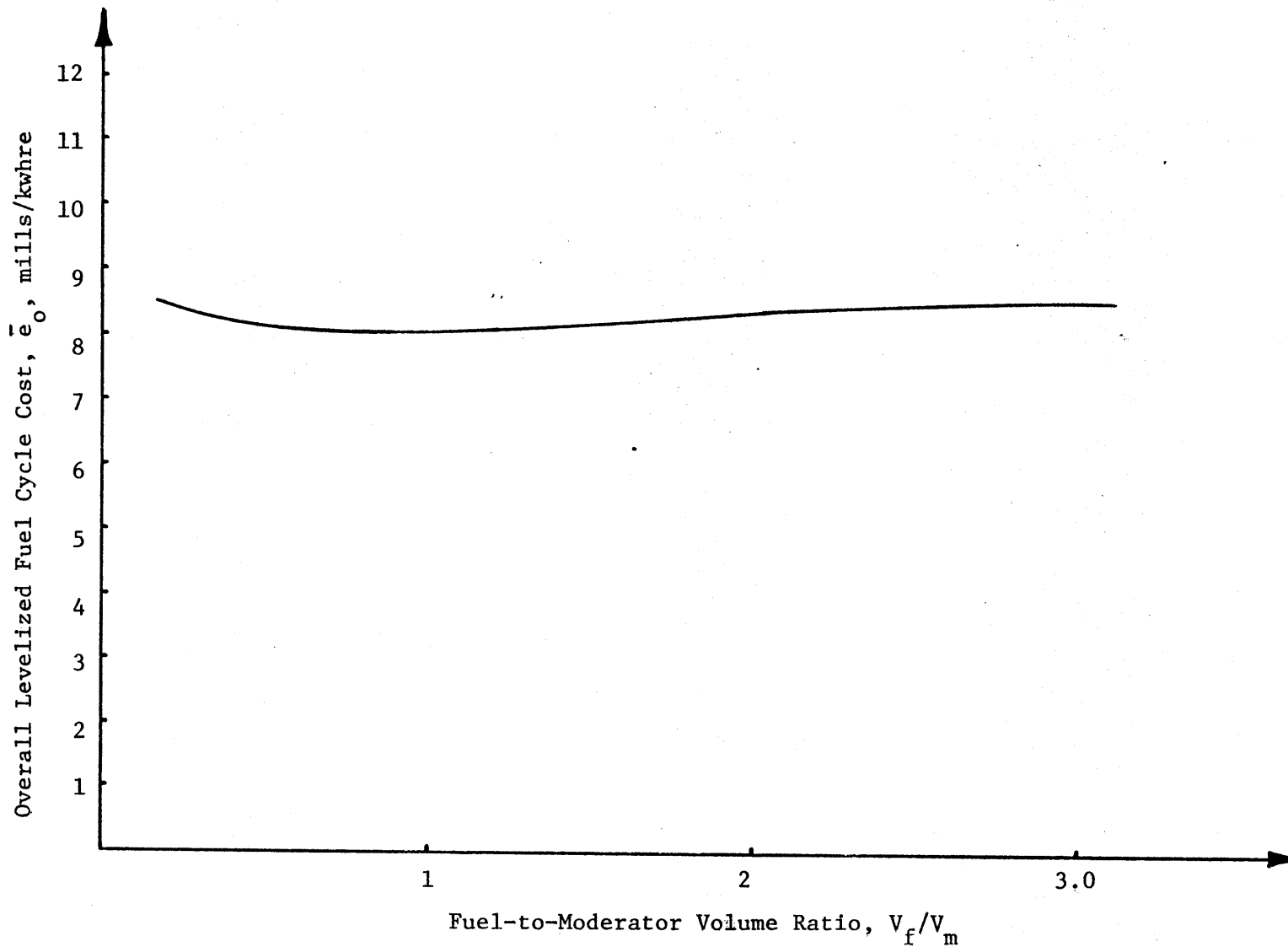

Figure 3.9 Overall Levelized Fuel Cycle Cost of  $^{235}\text{U}/^{232}\text{Th}$  Units Coupled with  $^{233}\text{U}/^{232}\text{Th}$  Units versus Fuel to Moderator Volume Ratio of the Consumer Reactor (Extended Scale)

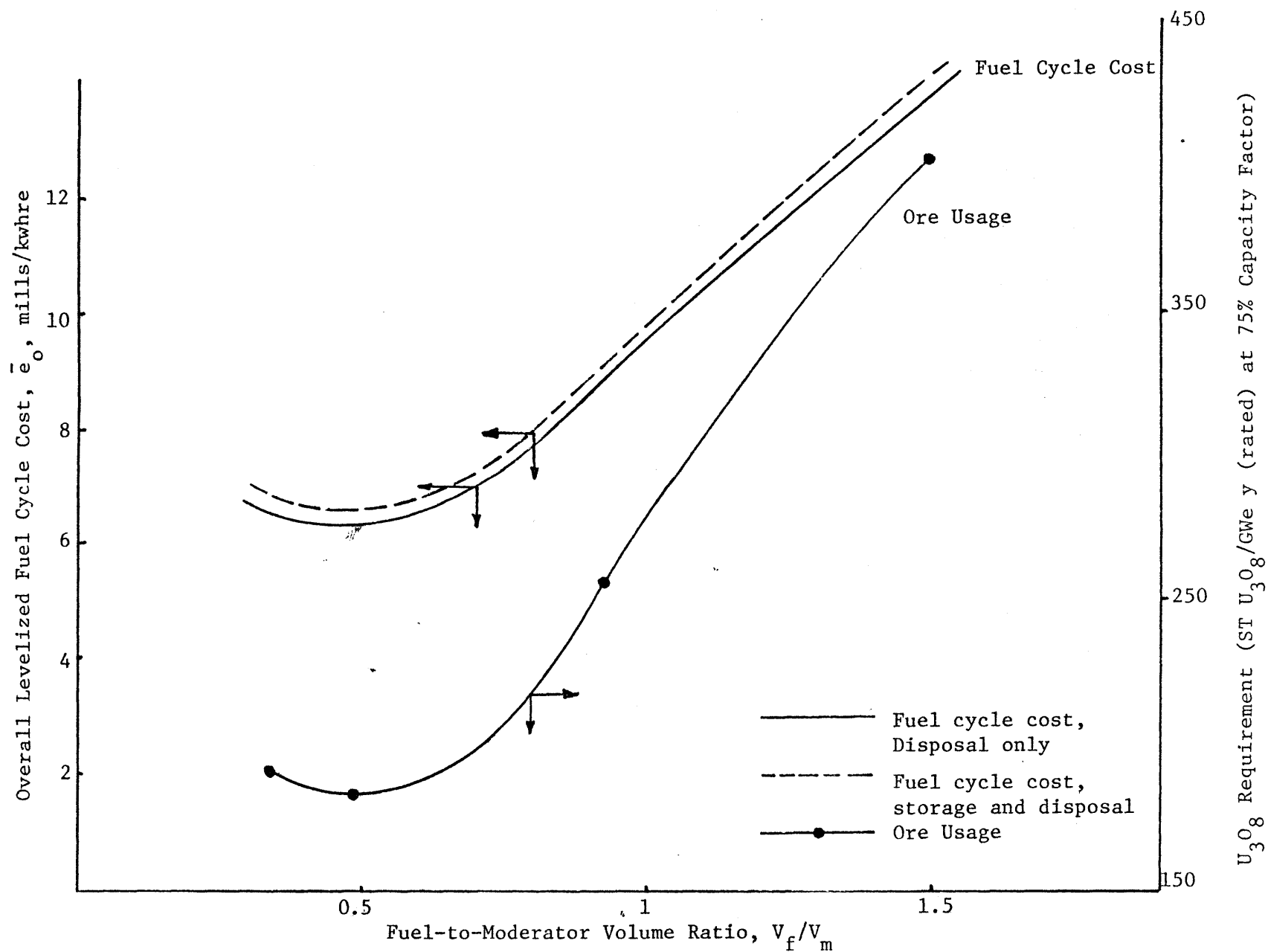

Figure 3.10 Fuel Cycle Cost and Ore Usage versus  $V_f/V_m$  for the Once-Through Fuel Cycle

TABLE 3-6

## ORE USAGE AND FUEL CYCLE COST FOR THE ONCE-THROUGH FUEL CYCLE

$\frac{V_f}{V_m}$	$\bar{e}_o$ mills/kwhre		$U_3O_8$ Requirement* (ST/GWe-yr)
	Disposal	Storage & Disposal	
0.338	6.36	6.67	190.40
0.4816	6.06	6.37	181.15
0.9161	8.45	8.75	255.3
1.497	13.25	13.55	401.7

\* 0%/yr system growth rate and 0.2% tail assay of separation plant

$V_f/V_m$ , both fuel cycle cost and ore usage increase very rapidly, and minima in both fuel cycle cost and ore usage occur at a  $V_f/V_m$  of about 0.5, which is again close to the  $V_f/V_m$  ratio of current PWR designs. We will return to a discussion of the once-through fuel cycle later, in Chapter 4, when burnup optimization is discussed.

### 3.4 Effect of Ore Scarcity on the Economics of Coupled Fuel Cycles

#### 3.4.1 Nature of the Problem

In the preceding sections the economics of coupled fuel cycles were investigated without considering the potential for an increase (in constant dollars) of unit prices with time. Costs will rise due to both inflation and increasing scarcity. If inflation is induced in the pricing structure (use of then-current dollars) then the actual market discount rates, which also contain an implicit allowance for inflation, must be used. In Appendix F it is shown that there is no difference between using a discount rate and unit prices which include inflation, and deflated discount rate together with constant-dollar prices. The discrepancy between the simple model and MITCOST-II increases with discount rate.

Therefore for this report instead of using inflated discount rates and escalating the unit prices, we use deflated discount rates and do not escalate unit prices. The second important factor affecting price level, namely scarcity, is important only in the case of ore price. Since all other costs are for manufacturing processes, their product unit prices in constant dollars should be relatively constant with time in the long run. There are of course factors which make time cost invariance unlikely in all specific cost centers: on one hand increasing regulatory requirements

may lead to cost increases, and on the other hand improved technology and economics of scale can lead to cost decreases. We assume here, in effect, the combined overall effect in all areas not involving ore production averages out to a fixed constant dollar contribution. For this report, scarcity-related escalation is only considered for the price of yellowcake - the primary natural resource involved in the nuclear fuel cycle - and the dominant cost component.

To study the effect of increasing ore price, three cases can be considered. In the first case it can be assumed that the time-zero cost of ore is constant and the escalation rate varies. In the second case the time-zero cost of ore is assumed to increase in a step-wise fashion and no further escalation is considered. Finally, it can be assumed that both the time-zero cost of ore for each scenario and the scarcity-related escalation rate are changed.

#### Case 1:

For this case it is assumed that the time-zero cost of ore is fixed at the price, given in Table (3-2) (40 \$/lb  $U_3O_8$ ) and the scarcity-related escalation rate,  $y$ , varies; two values of  $y$ , namely 6%/yr and 10%/yr are studied. Using the data given in Table (3-2) for the economic environment, the deflated discount rate, and Tables (E-1), (E-2), (E-3) and (E-4) for the mass transactions of uranium and thorium in SIMMOD, the overall levelized fuel cycle cost of producer and consumer reactors can be obtained as a function of the unit price of fissile material. Then from Figures similar to Figures (3-5) and (3-7) the overall levelized fuel cycle cost of a coupled cycle corresponding to the indifference value of fissile material can be determined. Figures (3.11a) and (3.11b) show the overall levelized fuel cycle cost of  $^{235}U/^{238}U$  units coupled with Pu/U units and  $^{235}U/^{232}Th$  units coupled with  $^{233}U/Th$  units,



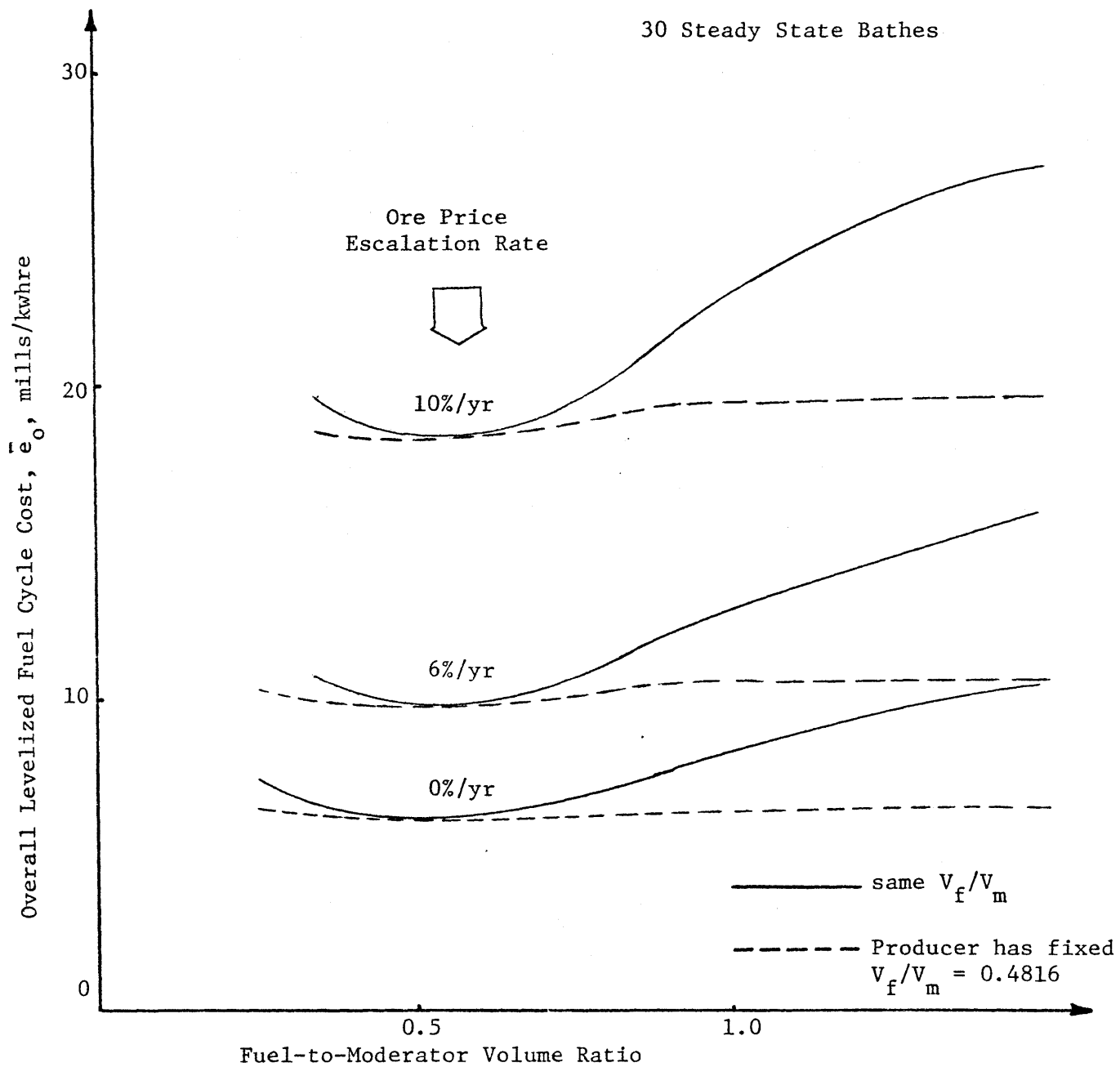

Figure 3.11a Overall Levelized Lifetime Fuel Cycle Cost of  $^{235}\text{U}/\text{U}$  units Coupled with  $\text{Pu}/\text{U}$  units versus  $V_f/V_m$  for 0%, 6% and 10%/yr Ore price Escalation Rate

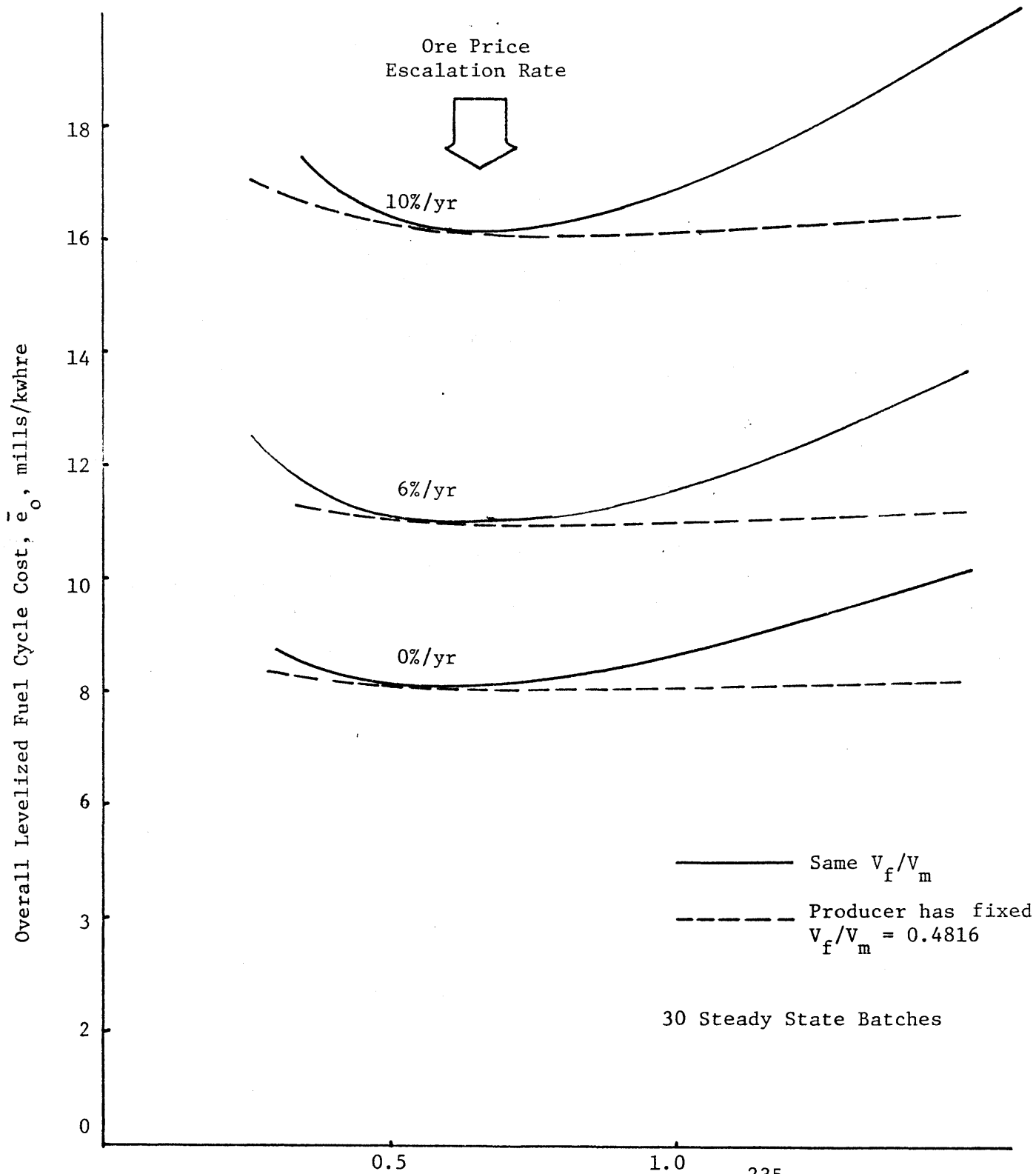

Figure 3.11b Overall Levelized Fuel Cycle Cost of  $^{235}\text{U}/\text{Th}$  Units Coupled with  $^{233}\text{U}/\text{Th}$  Units versus  $V_f/V_m$  for 0%, 6% and 10% yr Ore Price Escalation Rates

respectively, as a function of fuel-to-moderator volume ratio. These figures show that the escalation rate does not change the optimum fuel-to-moderator volume ratio appreciably:  $V_f/V_m$  equal to 0.5 for all values of the escalation rate gives the minimum overall levelized fuel cycle cost for  $^{235}\text{U}/\text{U}$  units coupled with  $\text{Pu}/\text{U}$  units (and  $V_f/V_m = 0.6$  for  $^{235}\text{U}/\text{Th}$  units coupled with  $^{233}\text{U}/\text{Th}$  units). Also (for the reason which was explained before), even at high escalation rates, for both types of coupled fuel cycles, using a producer reactor at fixed  $V_f/V_m$  (here equal to 0.4816), results in a fuel cycle cost which is insensitive to variation of the consumer reactor fuel-to-moderator ratio. Finally, it should be noted that increasing the scarcity-related escalation rate will further discourage any inclination to go to tight lattice pitches.

#### Case 2:

For this case, since the escalation rate for ore is equal to zero, the G factor (escalation factor) in the simple model is equal to 1 (see Section 2.2). Thus, using Equation (2.16), the overall levelized fuel cycle cost of coupled fuel cycles can be written as a linear function of ore price:

$$\bar{e}_o = \alpha C_{\text{U}_3\text{O}_8}(o) + \beta \quad (3.5)$$

where  $\alpha$  and  $\beta$  are two constants for each  $V_f/V_m$  and  $C_{\text{U}_3\text{O}_8}(o)$  is the time-zero cost of ore. Now if we increase the time-zero cost of ore from  $a$  to  $b$ , the fuel cycle cost, from Equation (3.5), will increase linearly from  $e_{oa}$  to  $e_{ob}$ . At this point we can consider a hypothetical G factor, namely  $G^*$ , where;

$$b = a G^* \quad (3.6)$$

Similarly for each hypothetical G factor a corresponding implied escalation rate,  $y^*$ , can be considered, which can be found from Equation (2.17 ). Therefore instead of changing  $C_{U_3O_8}(o)$  in a stepwise fashion, one can keep  $C_{U_3O_8}(o)$  constant and find the corresponding hypothetical G factor from Equation (3.6) and then by using Equation (2.17 ) the corresponding scarcity-related escalation rate. Considered in this light Case 2 becomes equivalent to Case 1, where  $C_{U_3O_8}(o)$  is constant and escalation rates are changed. Thus, the result is similar to those shown in Figures (3.11a) and (3.11b).

### Case 3

For this case it is first of all necessary to consider a model for ore price and ore escalation rate. A model of this type has been developed by K. Gharamani and M. J. Driscoll (G-2). According to this study the cost of  $U_3O_8$  for a system comprised of PWR reactors can be represented as follows:

$$C = C(o) e^{\delta t} \quad (3.7)$$

with

$$C(o) = 0.21 T^{-1/b} x^{-1} \quad (3.8)$$

where

$C$  =  $U_3O_8$  price at time  $t$ , \$/lb  $U_3O_8$

$C(o)$  = time-zero cost of  $U_3O_8$ , \$/lb  $U_3O_8$

$\delta$  = Escalation rate for the price of ore

$T$  = yearly industry-wide raw ore usage rate, tona/yr

$x$  = the grade of ore (weight of  $U_3O_8$  per weight of raw ore)

$t$  = time elapsed since base year, yr

The relation between the price escalation rate and the demand growth rate has been given in this study as

$$\delta = \frac{2}{3} r \quad (3.9)$$

Mean growth rates projected for installed nuclear capacity vary widely: between (at least) 7 and 14%/yr(N-2) which, according to Equation (3-9), will give us a scarcity rate spanning the range  $5 < 8 \leq 10$  %/yr. Thus two values, namely 6%/yr and 10%/yr were chosen for examination in this report.

It should be noted that the  $C(o)$  is actually an extrapolated time-zero cost of ore, as shown schematically in Figure (3.12). After a transition period the ore price reaches an asymptotic situation where it varies exponentially with time (Equation (3.7)). Thus at zero time, we have a fictional time-zero cost of ore, denoted by  $C(o)$ . In the exponential regime the slope of the curve depends on the growth rate and increases as the growth rate is increased. Also note that  $C(o)$  depends on the annual ore use rate per GWe yr by the dominant or mean reactor type in service. Thus, if the initial transient period is ignored, different time-zero extrapolated ore costs should be considered. As can be seen from Tables (E-2) and (E-4), for each fuel-to-moderator volume ratio the ore requirement per batch (i.e. annual ore usage) is different; therefore for economic analysis of coupled cycles the fictional variation of the time-zero cost of ore has to be considered.

According to the development in reference (G-3), the time-zero extrapolated reference ore value varies as

$$C(o) = C_R(o) \left(\frac{m}{m_R}\right)^{2/3} \quad (3.10)$$

where

$C_R(o)$  = reference unit price of  $U_3O_8$  when the system is made up of PWR reactors of current design ( $V_f/V_m = 0.4816$ )

$C(o)$  = reference price of  $U_3O_8$  when the system is made up of some other type of reactor

$m_R$  = yearly demand for  $U_3O_8$  of a system consisting of current PWR reactors, tons/MWe yr

$m$  = yearly demand for  $U_3O_8$  of a system of modified reactors, tonnes/MWe yr

In this study, if we assume that  $C_R(o)$  is the reference ore price appropriate for current design PWRs using the uranium cycle, then varying the fuel-to-moderator volume ratio or using any other cycle instead of the uranium cycle will cause the yearly demand for  $U_3O_8$  to change, and thus according to Equation (3.10) the time-zero cost of ore will change.

To consider this variation in ore economic analyses, the correct reference price of ore in the current market is assumed to be 40 \$/lb  $U_3O_8$ , and current design PWRs are represented by the Maine-Yankee reactor (with fuel-to-moderator volume ratio equal to 0.4816 operating on the once-through uranium cycle). Then, by employing the data given in Tables (3-3), (3-4) and (3-6) and using Equation (3-10) one can find the time-zero cost of ore for each scenario when producer and consumer reactors have the same  $V_f/V_m$ , and when  $V_f/V_m$  is fixed at 0.4816 and then at 0.9161 for the producer reactor

(the minimum ore usage or minimum fuel cycle cost systems are included among these combinations), as tabulated in Table (3.7). Figure (3.13) shows the overall levelized fuel cycle cost when different time-zero costs of ore from Table (3.7) have been employed.

Comparing this figure with Figures (3.6) and (3.8) reveals that, using a different time-zero cost of ore will give a fuel cycle cost versus  $V_f/V_m$  curve which is slightly flatter than if one uses the same time-zero cost of ore, if both producer and consumer reactor have the same  $V_f/V_m$ . However, fixing the  $V_f/V_m$  of the producer reactor at  $V_f/V_m$  equal to 0.4816 and using different time zero costs of ore causes the overall levelized fuel cycle cost for the  $^{235}\text{U}/\text{Th} : ^{233}\text{U} / \text{Th}$  combination to decrease slightly as  $V_f/V_m$  increases, whereas for the  $^{235}\text{U}/\text{U} : \text{Pu}/\text{U}$  combination tight-pitch lattices became less attractive. The effect of escalation rate can be readily understood by examining the  $C(o)$  values in Table (3.7). According to this table, the time zero cost of ore for  $^{235}\text{U}/\text{Th} : ^{233}\text{U} / \text{Th}$  systems decreases as we go to tighter lattice pitches, since annual ore usage for this coupled cycle is decreased as  $V_f/V_m$  is increased. Thus escalation of ore price makes this advantage of tighter-lattice pitch more pronounced. For  $^{235}\text{U}/\text{U} : \text{Pu}/\text{U}$  systems the annual ore usage increases with increasing fuel-to-moderator volume ratio. Thus, as can be seen from Table (3.7), the time-zero cost of ore will increase as we go to tight-lattice pitches. Therefore, escalating the ore price discourages going to tight lattice pitch. Consequently the effect of increasing the escalation rate for ore price is favorable only for  $^{235}\text{U}/\text{Th} : ^{233}\text{U} / \text{Th}$  systems. It should be noted that in the case of  $^{235}\text{U}/\text{U} : \text{Pu}/\text{U}$  cycles the minimum time-zero cost of ore (26.80 \$/lb  $\text{U}_3\text{O}_8$ ) is for  $V_f/V_m$  equal to 0.9161

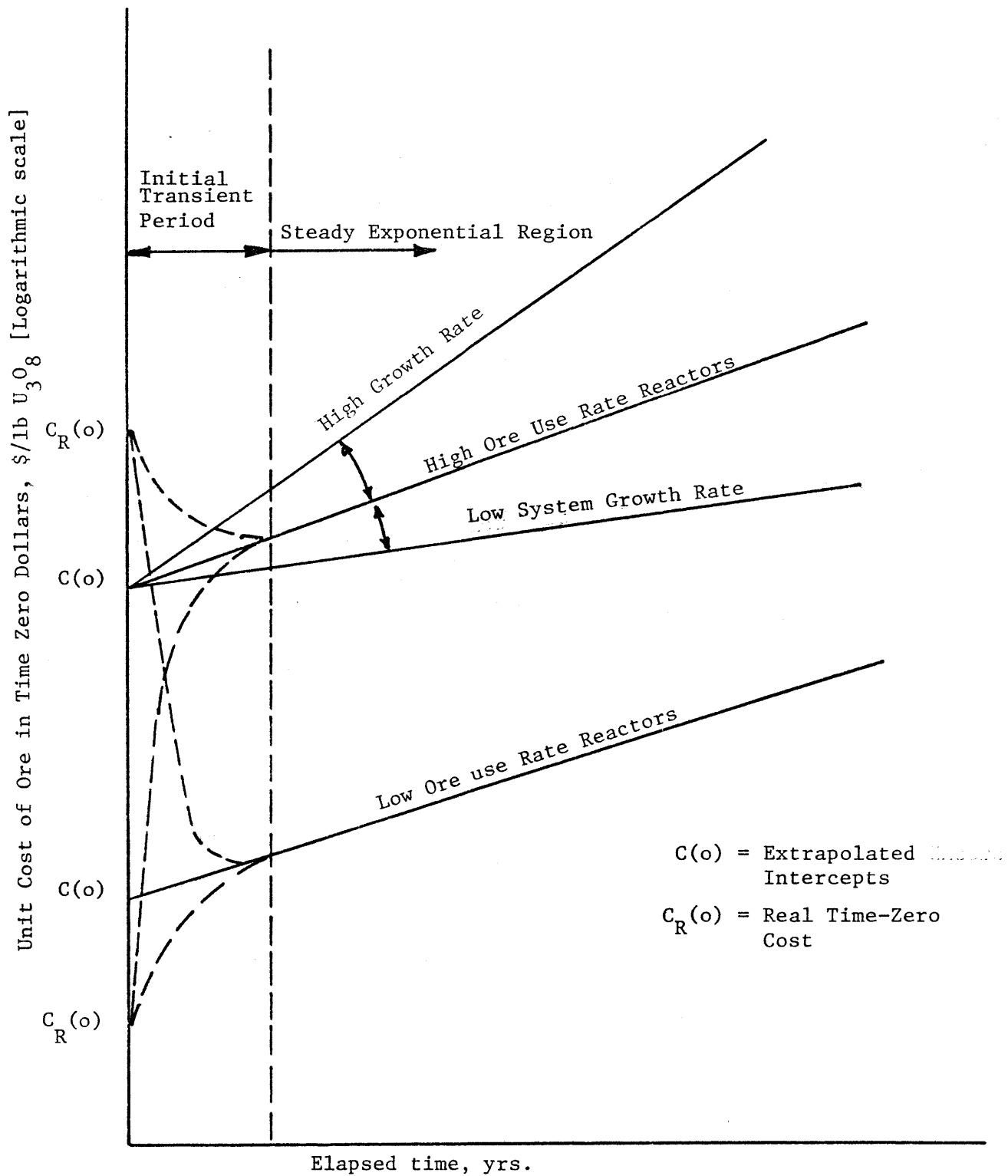

Figure 3.12 Schematic Representation of Ore Price Escalation Scenarios



TABLE 3-7

## TIME-ZERO COST OF ORE FOR DIFFERENT SCENARIOS

$V_f/V_m$ Producer	$V_f/V_m$ Consumer	$^{235}\text{U}/\text{U} : \text{Pu}/\text{U}$		$^{235}\text{U}/\text{Th} : ^{233}\text{U}/\text{Th}$	
		$m/m_R^*$	(Co) \$/lb $\text{U}_3\text{O}_8$	$m/m_R^*$	(Co) \$/lb $\text{U}_3\text{O}_8$
0.338	0.338	0.72	32.15	0.58	27.88
0.4816	0.4816	0.61	28.71	0.50	25.19
0.9161	0.9161	0.64	29.75	0.44	23.22
1.497	1.497	0.70	31.44	0.44	23.04
0.4816	0.338	0.63	29.48	0.54	26.60
0.4816	0.9161	0.67	30.72	0.46	23.77
0.4816	1.497	0.68	20.81	0.43	22.96
0.9161	0.338	0.58	27.91	0.53	26.80
0.9161	0.4816	0.55	26.80	0.48	24.69
0.9161	1.497	0.65	29.87	0.42	22.39

\* $m_R$  for the reference case is 181.15 ST/GWe-yr

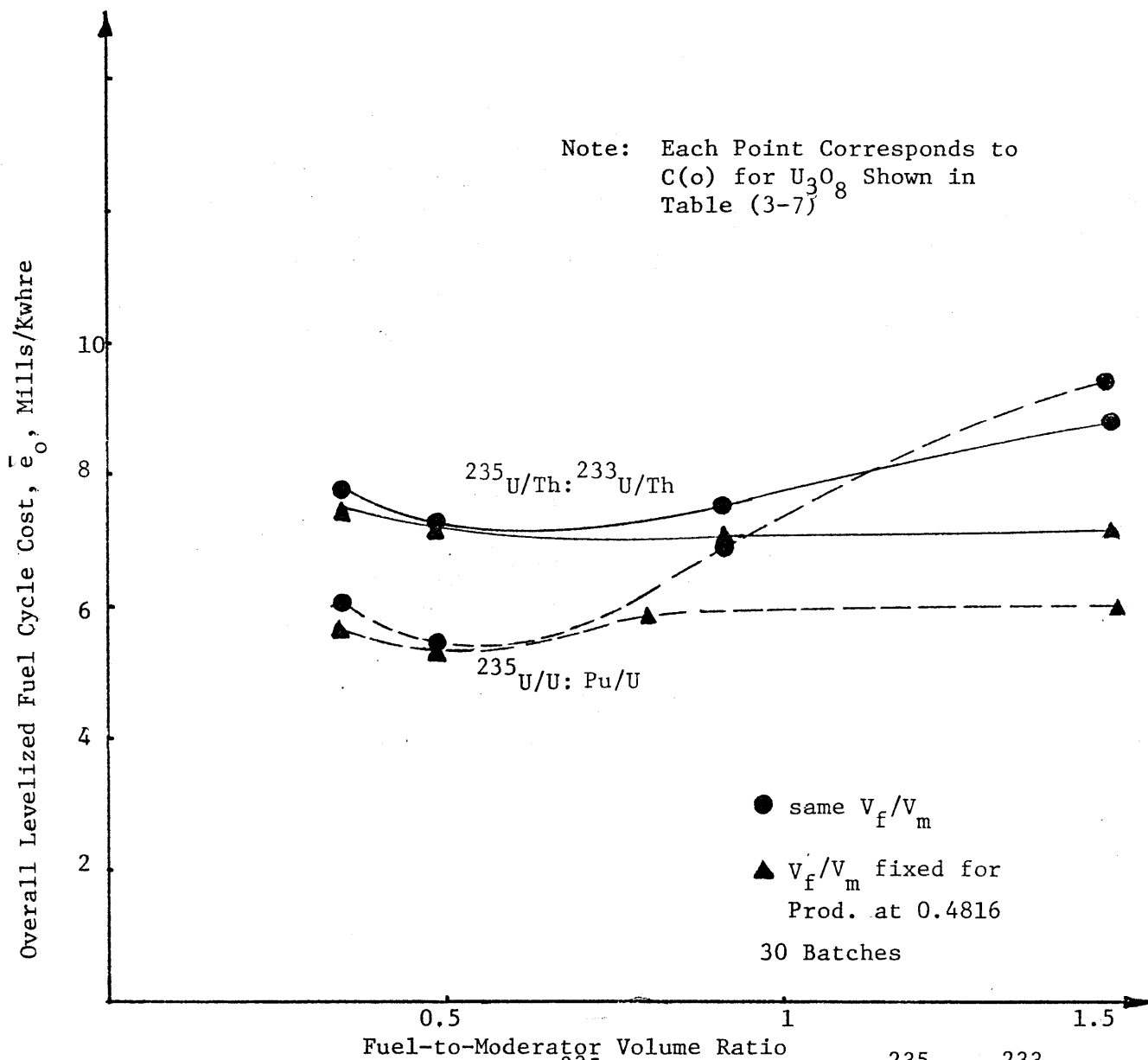

Figure 3.13 Fuel Cycle Cost of  $^{235}U/U:Pu/U$  System and  $^{235}U/Th: ^{233}U/Th$  Systems versus  $V_f/V_m$  for Different Time zero Cost of Ore and 0% Escalation Rate<sup>m</sup>

and 0.4816 for producer and consumer reactors, respectively (see Table (3.7)). However, the difference is only about two dollars with respect to the case where producer and consumer reactors have their optimum (from the point of view of fuel cycle cost)  $V_f/V_m$  value (at which  $C(o) = 28.71$  \$/lb  $U_3O_8$ ). This two dollar cheaper price of ore is not able to overcome the other advantages of the latter case, in that the fuel cycle cost is minimum where both producer and consumer reactor have  $V_f/V_m$  equal to 0.4816 (same as Case 1, where the time-zero cost of ore was assumed to be the same for all cases).

### 3.5 Comparative Analysis of Coupled Fuel Cycles

In this section the merits of different scenarios will be studied. Figure (3-14a) shows the fuel cycle cost of  $^{235}U/U:Pu/U$  and  $^{235}U/Th:^{233}U/Th$  systems versus fuel-to-moderator volume ratio for 0, 6 and 10%/yr escalation rates (this figure has been reconstructed from previous results). According to this figure, the  $^{235}U/U:Pu/U$  system is better than the  $^{235}U/Th:^{233}U/Th$  arrangement when each coupled cycle has its optimum fuel-to-moderator volume ratio, that is, the  $V_f/V_m$  which results in a minimum fuel cycle cost. Only for high rates of ore price escalation does  $^{235}U/Th:^{233}U/Th$  become better than  $^{235}U/U:Pu/U$ . As we go to tight-lattice pitches  $^{235}U/Th:^{233}U/Th$  approaches and then surpasses  $^{235}U/U:Pu/U$ , in that, at a  $V_f/V_m$  equal to 1.497, for all escalation rates,  $^{235}U/Th:^{233}U/Th$  is the better choice. Note that if the  $V_f/V_m$  of the producer reactor is fixed at 0.4816, then for tight-lattice pitches

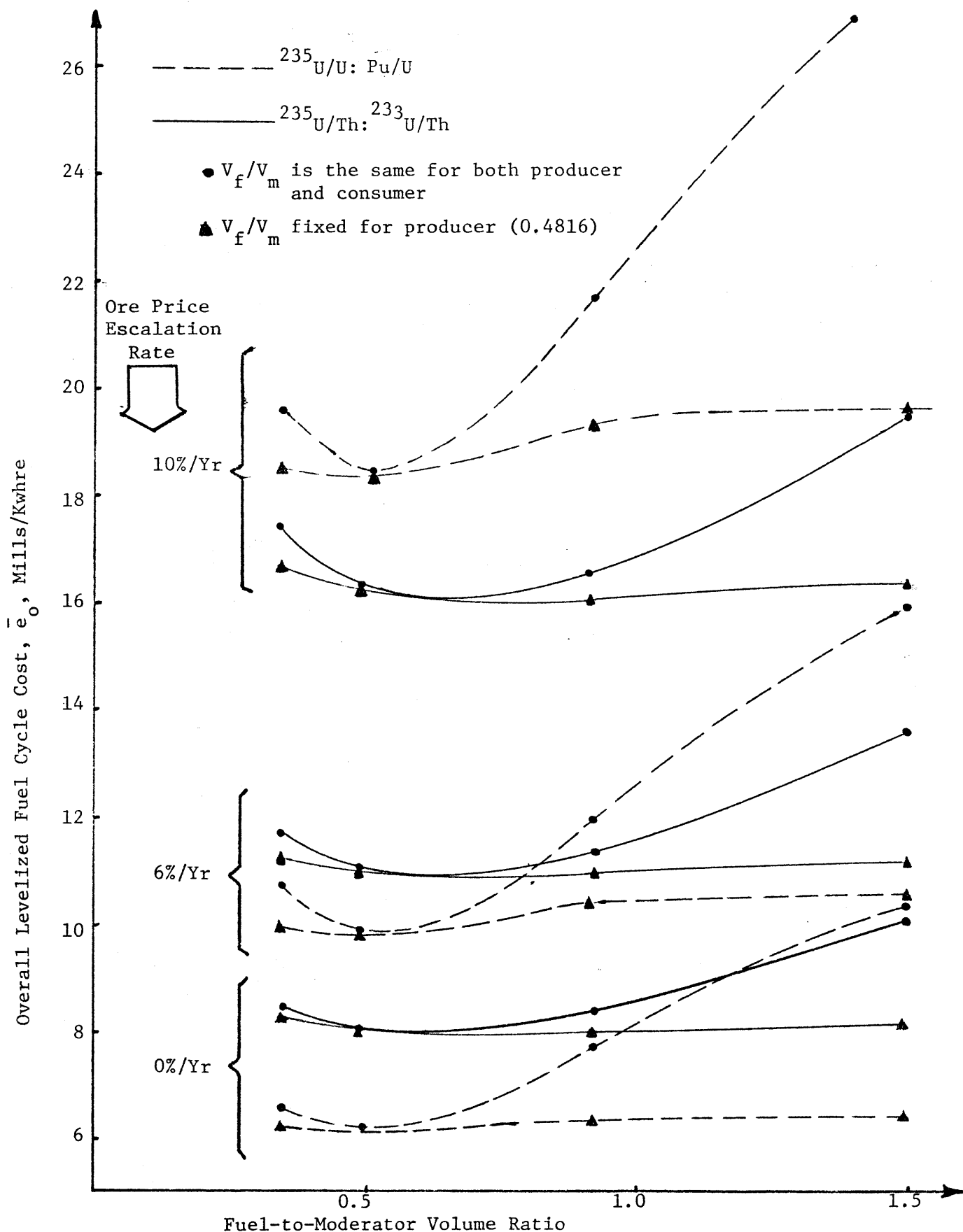

Figure 3.14a Overall Levelized Fuel Cycle Cost Versus  $V_f/V_m$  for  $^{235}\text{U/U: Pu/U}$  and  $^{235}\text{U/Th: } ^{233}\text{U/Th}$  Systems (30 Steady State Batches)

$^{235}\text{U}/\text{Pu}$  is the best, and again only for high rates of escalation is  $^{235}\text{U}/\text{Th} : ^{233}\text{U}/\text{Th}$  advantageous.

It should be noted that up to this point the number of steady state batches for both coupled cycles were assumed to be equal (30 batches). Since the intra-refueling interval is different for each coupled cycle, the life span of the  $^{235}\text{U}/\text{U}:\text{Pu}/\text{U}$  system is greater than that of the  $^{235}\text{U}/\text{Th} : ^{233}\text{U}/\text{Th}$  system (42 years versus 37 years). Therefore, the  $^{235}\text{U}/\text{U}:\text{Pu}/\text{U}$  system has been penalized relative to  $^{235}\text{U}/\text{Th} : ^{233}\text{U}/\text{Th}$  system. If instead of matching the number of batches, we fix the lifetime of the two coupled systems, as can be seen from Figure (3-14b) even for a 10%/yr escalation rate, for optimum fuel-to-moderator volume ratios the  $^{235}\text{U}/\text{U}:\text{Pu}/\text{U}$  system is a better choice, and only at the highest escalation rate, and for  $V_f/V_m$  greater than 1.0 is the  $^{235}\text{U}/\text{Th} : ^{233}\text{U}/\text{Th}$  system better. However, at this fuel-to-moderator volume ratio the fuel cycle cost is far from the minimum.

To determine the breakeven escalation rate (at which neither coupled cycle has an advantage over the other), the fuel cycle cost (both coupled cycles have 30 batches), versus escalation rate was examined for two cases, namely (a) each coupled cycle has its optimum  $V_f/V_m$  and (b) when both producer and consumer reactors have  $V_f/V_m = 1.497$ . The results are shown in Fig. (3-15). Also, for

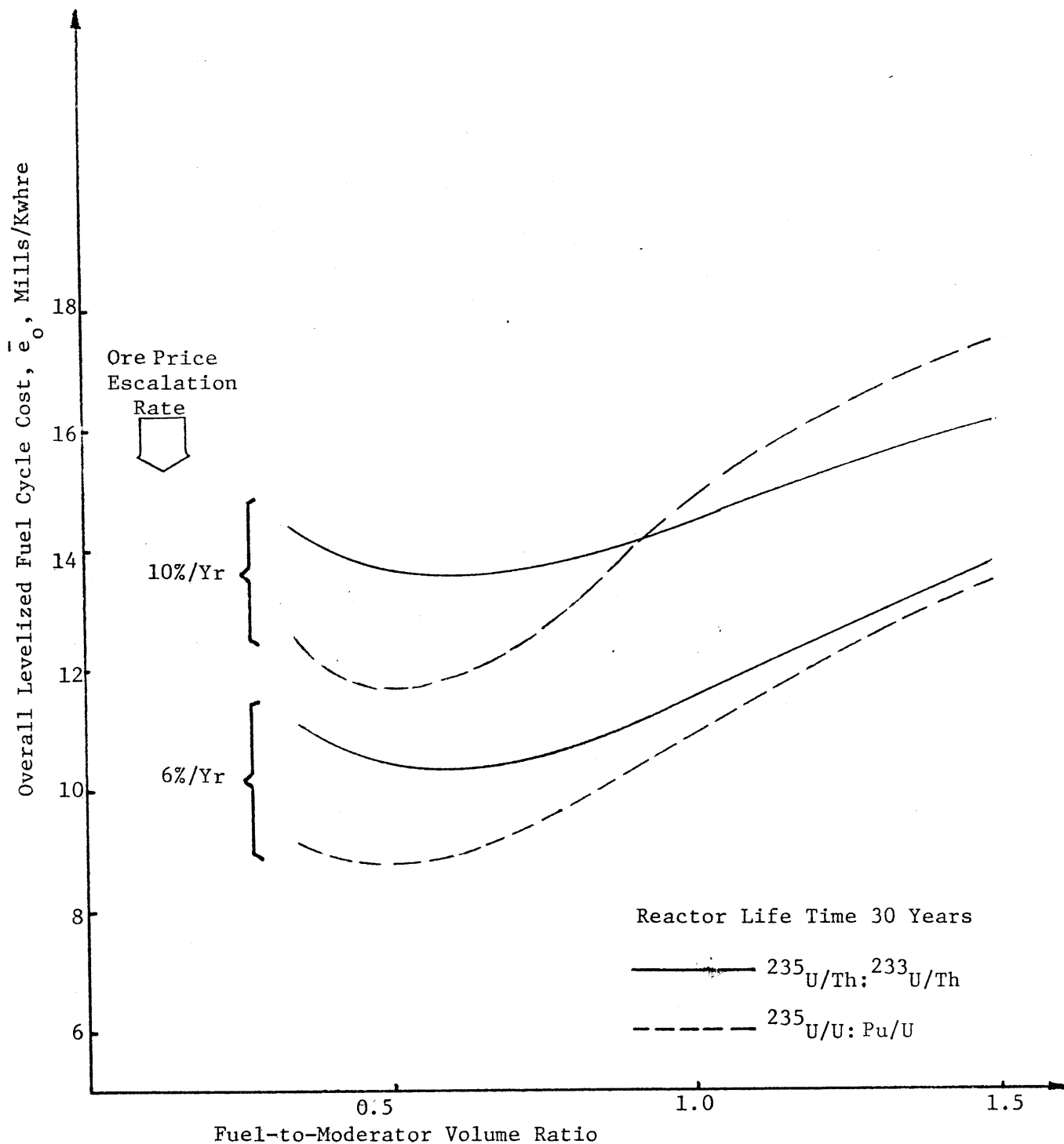

Figure 3.14b Overall Levelized Fuel Cycle Cost Versus  $V_f/V_m$  for  $^{238}\text{U}/\text{U}; \text{Pu}/\text{U}$  and  $^{235}\text{U}/\text{Th}; ^{233}\text{U}/\text{Th}$  Systems (Reactor Lifetime 30 Years)

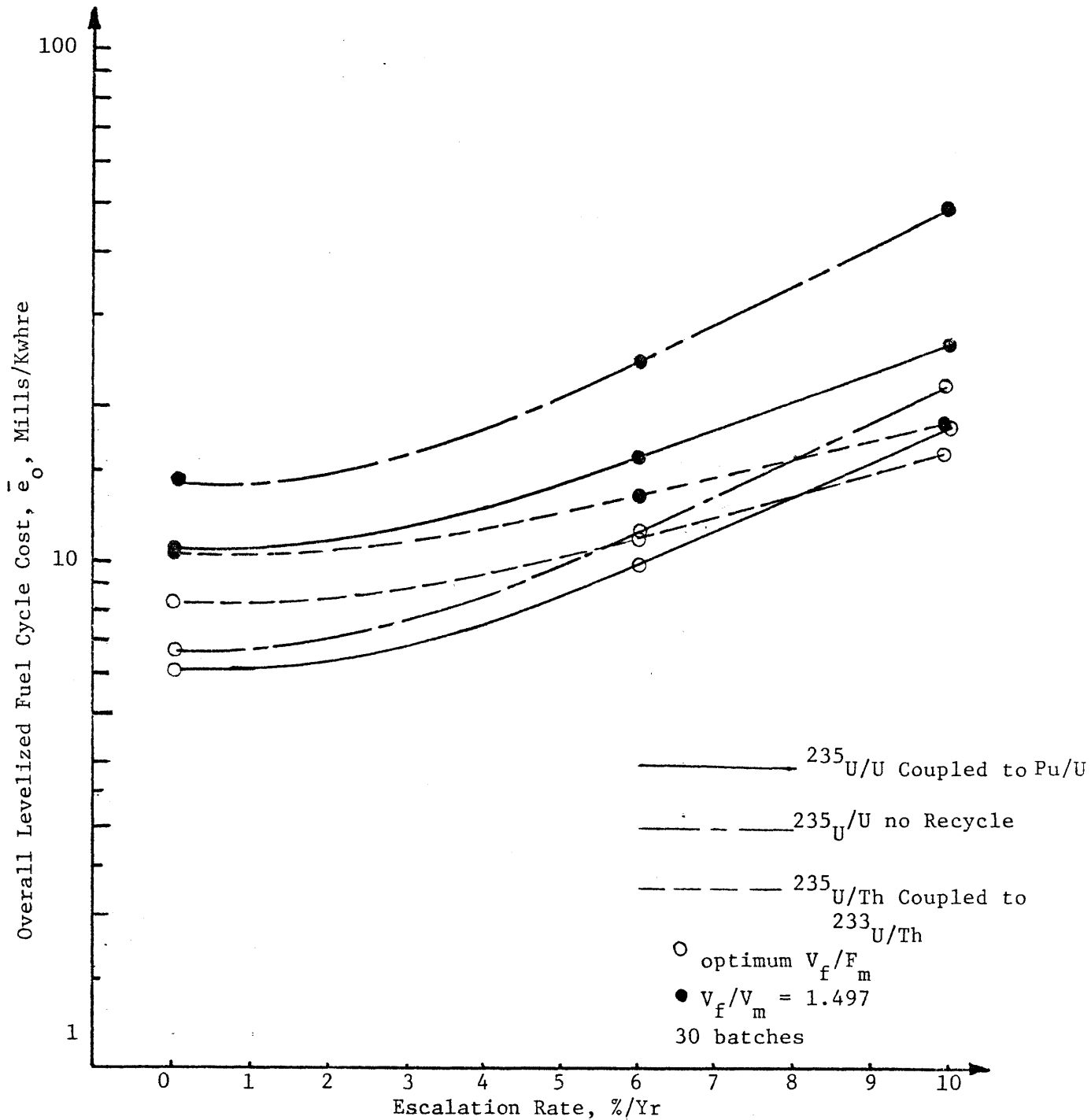

Figure 3.15 Fuel Cycle Cost as a Function of Ore Escalation Rate  
 (Time Zero-Cost of Ore is the Same for all Cases)

comparison,  $^{235}\text{U}/\text{U}$  fueling without recycle has been shown in this figure. First of all, for optimum  $V_f/V_m$ , up to an 8%/yr scarcity related (i.e. inflation free) escalation rate  $^{235}\text{U}/\text{U}:\text{Pu}/\text{U}$  is better than  $^{235}\text{U}/\text{Th}:\text{}^{233}\text{U}/\text{Th}$ . Even for this case, up to an escalation rate of 5.5%/yr,  $^{235}\text{U}/\text{U}$  without recycle is better than  $^{235}\text{U}/\text{Th}:\text{}^{233}\text{U}/\text{Th}$ . However for the tight-lattice pitch case for all escalation rates,  $^{235}\text{U}/\text{Th}:\text{}^{233}\text{U}/\text{Th}$  is preferred. It should be noted that since fixing  $V_f/V_m$  for producer reactors at 0.4816 results in a fuel cycle cost very close to that at the optimum  $V_f/V_m$ , and the cost does not change appreciably with variation of  $V_f/V_m$  of the consumer reactor, the plot of fuel cycle cost versus ore price escalation for the optimum case can also be considered representative of the case in which  $V_f/V_m$  of the producer reactors is fixed at 0.4816.

The above analysis was on the basis of the same time-zero cost of ore for all cases (40 \$/lb  $\text{U}_3\text{O}_8$ ). However, as discussed before, variation of the (extrapolated) time-zero cost of ore should also be considered. According to Table (3.7), the time zero cost of ore for all cases for coupled  $^{235}\text{U}/\text{Th}:\text{}^{233}\text{U}/\text{Th}$  cycles is lower than for the  $^{235}\text{U}/\text{U}:\text{Pu}/\text{U}$  cases. This favors the  $^{235}\text{U}/\text{Th}:\text{}^{233}\text{U}/\text{Th}$  combination and it becomes comparable to its competitor, the  $^{235}\text{U}/\text{U}:\text{Pu}/\text{U}$  system, at lower escalation rates than before.

This behavior can be readily explained. Figure (3 16a) shows (schematically) the variation of fuel cycle cost with the unit price of fissile material, for zero escalation rate, for  $^{235}\text{U}/\text{U}$  (line A),  $\text{Pu}/\text{U}$  (line B),  $^{235}\text{U}/\text{Th}$  (line C) and  $^{233}\text{U}/\text{Th}$  (line D) (similar to Figures (3-5)



and (3-7)) where  $V_f/V_m$  is in the lower end of the range of interest (current reactor designs). As can be seen, the traces for the consumer reactor are close to each other (lines B and D) but line C is well separated from line A, since at low  $V_f/V_m$ ,  $^{235}\text{U}/\text{U}$  uses less ore and less separative work. Thus the intersection point of line A and B ( $P_1$ ) has a lower height than that of lines C and D ( $P_2$ ), which results in a lower fuel cycle cost for the  $^{235}\text{U}/\text{U}:\text{Pu}/\text{U}$  combination. As the escalation rate for ore increases lines D and C do not change, since the consumer reactor does not use fissile  $^{235}\text{U}$  (hence does not need ore); but lines A and C shift to A' and C', respectively, (see Figure (3-16a)). As the escalation rate increases, the fuel cycle cost of  $^{235}\text{U}/\text{U}$  units increases more rapidly than that of  $^{235}\text{U}/\text{Th}$  units. Therefore, for high escalation rates lines C' and A' are close to each other. The slope of line C' is greater than that of line A' (since the fissile mass discharged from  $^{235}\text{U}/\text{Th}$  cores is greater than that from  $^{235}\text{U}/\text{U}$  cores, and thus the  $^{235}\text{U}/\text{Th}$  core is more sensitive to a variation of fissile price); consequently, the intersection point of lines C' and D ( $P'_2$ ) has a lower height than the intersection point of lines A' and B ( $P'_1$ ). Therefore, for high escalation rates the  $^{235}\text{U}/\text{Th}:\text{Pu}/\text{Th}$  combination is the better option.

As the fuel-to-moderator volume ratio is varied, the traces of fuel cycle cost change as shown in Figure (3-16b). For high  $V_f/V_m$  the net inventory charge for Pu/U is much greater than for  $^{233}\text{U}/\text{Th}$ , therefore line B is above line D and has a greater slope. The ore requirement for the  $^{235}\text{U}/^{232}\text{Th}$  unit for this case (high  $V_f/V_m$ ) is smaller than that for the  $^{235}\text{U}/\text{U}$  case, but the separative work requirement is greater (see Tables (E-2) and (E-4) in Appendix E). The net result is that the fuel cycle cost for the  $^{235}\text{U}/\text{Th}$  case is greater (but close to) that for the  $^{235}\text{U}/\text{U}$  case (lines C

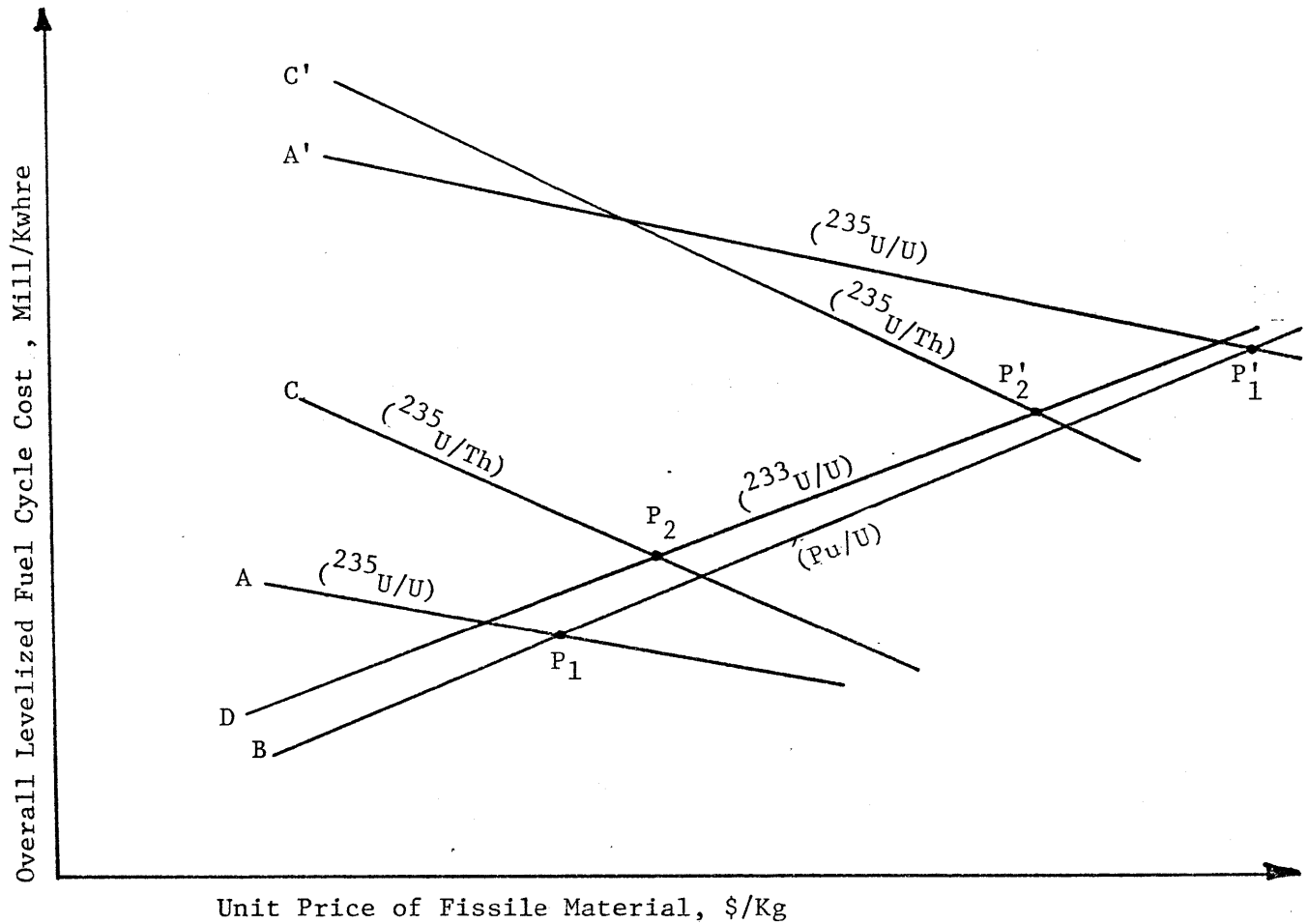

Figure 3.16a Fuel Cycle Cost as a Function of Fissile Price for Low  $V_f/V_m$

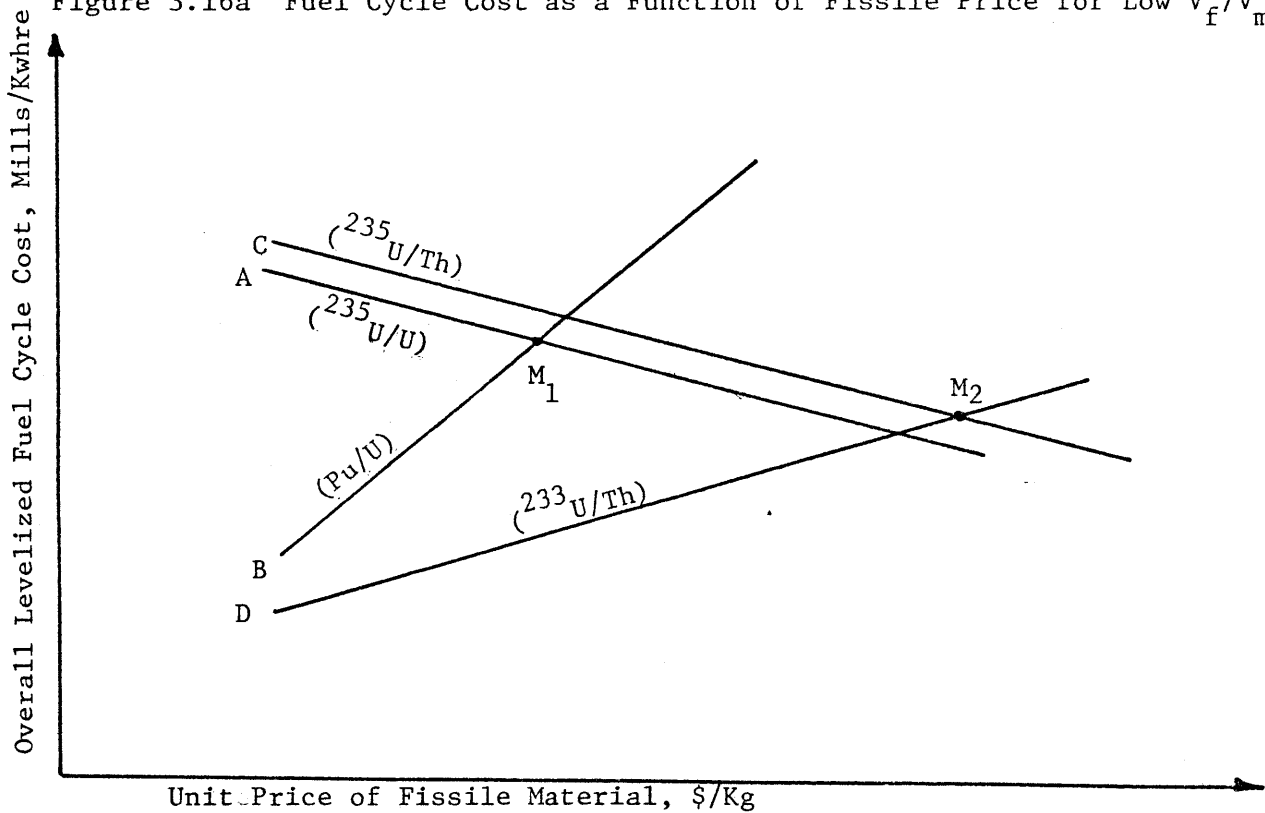

Figure 3.16b Fuel Cycle as a Function of Fissile Price for High  $V_f/V_m$

and A in Figure (3-16b)), therefore the intersection point of lines A and B ( $M_1$ ) falls above the intersection point of line D and C. As a result the fuel cycle cost of the  $^{235}\text{U}/\text{Th} : ^{233}\text{U}/\text{Th}$  combination is lower than that for the  $^{235}\text{U}/\text{U} : \text{Pu}/\text{U}$  cases. As the escalation rate is increased, line A rises faster than line C, which makes the situation better for the  $^{235}\text{U}/\text{Th} : ^{233}\text{U}/\text{Th}$  cycles. Consequently for all escalation rates and for high  $V_f/V_m$ ,  $^{235}\text{U}/\text{Th} : ^{233}\text{U}/\text{Th}$  is the better option (if the number of batches are matched); in this off-optimum range of operating conditions.

### 3.6 The Unit Price of Fissile Material

In Section 3.3.2 the way in which the unit price of fissile material can be determined was discussed. In this section this method will be used to develop explicit correlations for the indifference price of plutonium and  $^{233}\text{U}$ .

Our simple model for the fuel cycle costs of producer and consumer reactors can be written

$$e_p = \frac{1}{E} \left\{ \sum_{i=1}^I M_{i i i i}^P C_{i i i i}^P + [M_{o o o o}^P |_{\text{ch}} - M_{o o o o}^P |_{\text{dis}}] C_{\text{U}_3\text{O}_8} \right. \\ \left. + [M_{s s s s}^P |_{\text{ch}} - M_{s s s s}^P |_{\text{dis}}] C_{\text{SW}} - M_{f f f f}^P |_{\text{fiss}} \cdot C_{\text{fiss}} \right\} \quad (3.11a)$$

$$e_c = \frac{1}{E} \left\{ \sum_{i=1}^I M_{i i i i}^C C_{i i i i}^C + [M_{f f f f}^C |_{\text{ch}} - M_{f f f f}^C |_{\text{dis}}] C_{\text{fiss}} \right\} \quad (3.11b)$$

Thus, if we define

$$\sum_{\substack{i=1 \\ i \neq U_3O_8, SW, fissile}}^I M_i^P C_i^P F_i^P G_i^P = \gamma_P \quad (3.12)$$

$$\sum_{\substack{i=1 \\ i \neq fissile}}^I M_i^C C_i^F G_i^P = \gamma_C \quad (3.13)$$

by equating Equations 3.11a and 3.11b and solving for  $C_{fiss}$ , we obtain;

$$C_{fiss} = \frac{[M_{O_o_o_o}^{P_P_P_P} |_{ch} - M_{O_o_o_o}^{P_P_P_P} |_{dis}] C_{U_3O_8} + [M_{S_s_s_s}^{P_P_P_P} |_{ch} - M_{S_s_s_s}^{P_P_P_P} |_{dis}] C_{SW} + \gamma_P - \gamma_C}{M_{F_f_f_f}^{C_C_C_C} |_{ch} - M_{F_f_f_f}^{C_C_C_C} |_{dis} + M_{F_f_f_f}^{P_P_P_P} |_{dis}} \quad (3.14)$$

We next define

$$\Delta M_{O_o_o_o} \triangleq M_{O_o_o_o}^{P_P_P_P} |_{ch} - M_{O_o_o_o}^{P_P_P_P} |_{dis} \quad (3.15)$$

$$\Delta M_{S_s_s_s} \triangleq M_{S_s_s_s}^{P_P_P_P} |_{ch} - M_{S_s_s_s}^{P_P_P_P} |_{dis} \quad (3.16)$$

$$\Delta M_{F_f_f_f} \triangleq M_{F_f_f_f}^{C_C_C_C} |_{ch} - M_{F_f_f_f}^{C_C_C_C} |_{dis} + M_{F_f_f_f}^{P_P_P_P} |_{dis} \quad (3.17)$$

where the parameters have the same definitions given in Chapter 2, and the subscripts and superscripts have the following significance:

o = ore

s = SWU

F = fissile

ch = charged to reactor

dis = discharged from reactor

C = consumer reactor

P = producer reactor

and

$C_{fiss}$  = fissile price, \$/kg

$C_{U_3O_8}$  = ore price, \$/lb

$C_{SWU}$  = unit price of separative work, \$/kg SWU

Note that the summations in Equations (3.11a) and (3.11b) represent all steps except purchase or credit for ore, separative work and fissile material. Therefore for a given design of the producer and consumer reactors these terms are constant and do not change with variation of ore or SWU prices, in which case:

$$C_{fiss} = \frac{(\Delta M_{o o o}^{F G})C_{U_3O_8} + (\Delta M_{s s s}^{F G})C_s + \gamma_P - \gamma_C}{\Delta M_{F F F}^{F G}} \quad (3.18)$$

For further simplification, we define

$$\alpha = \frac{\Delta M_{o o o}^{F G}}{\Delta M_{F F F}^{F G}} \quad (3.19)$$

$$\beta = \frac{\Delta M_{s s s}^{F G}}{\Delta M_{F F F}^{F G}} \quad (3.20)$$

$$\tau = \frac{\gamma_P - \gamma_C}{\Delta M_{F F F}^{F G}} \quad (3.21)$$

Then Equation (3.18) can be written as

$$C_{fiss} = \alpha C_{U_3O_8} + \beta C_{SW} + \tau \quad (3.22)$$

Note that if we assume that the discount rate is equal to zero (F and G equal to 1),  $\alpha$  and  $\beta$  are proportional to the net ore usage and net separative work requirement. Note that with variation of  $V_f/V_m$ , parameters such as  $M_O^P$ ,  $M_S^P$ ,  $M_F^D$ ,  $M_F^C$  etc., will change; therefore  $\alpha$ ,  $\beta$ ,  $\tau$  vary with  $V_f/V_m$ . In general any changes which result in a change in the amount of  $^{235}\text{U}$  charged and discharged (or separative work and bred fissile material) will change  $\alpha$ ,  $\beta$  and  $\tau$  (changing parameters such as the unit cost of fabrication will affect only  $\tau$ : here we assume the other parameters are invariant). Thus, no unique price of fissile material can be defined, as the price depends on the conditions under which it has been produced.

In the previous section it was shown that if both producer and consumer reactor have  $V_f/V_m$  equal to 0.4816, the fuel cycle cost is minimum among other combination for  $^{235}\text{U}/\text{U}$  units coupled to Pu/U units; for  $^{235}\text{U}/\text{Th}$  units coupled with  $^{233}\text{U}/\text{Th}$  units the minimum fuel cycle cost occurs when the producer and consumer reactors have  $V_f/V_m$  equal to 0.4816 and 0.9161, respectively. Since the production of electricity at minimum price is the goal of utilities, these cases will be chosen for each coupled fuel cycle to determine  $\alpha$ ,  $\beta$  and  $\tau$ . Using the best combination of producer and consumer reactors, one finds:

$$C_{\text{PU}} = 0.578 C_{\text{U}_3\text{O}_8} + 0.178 C_{\text{SW}} - 13.90 \quad \$/\text{gr} \quad (3.23)$$

$$C_{\text{U-3}} = 0.678 C_{\text{U}_3\text{O}_8} + 0.318 C_{\text{SW}} - 13.72 \quad \$/\text{gr} \quad (3.24)$$

where  $C_{\text{PU}}$  and  $C_{\text{U-3}}$  are the unit price of fissile Pu and  $^{233}\text{U}$ , respectively in  $\$/\text{gr}$ . Equation (3-4) also gives the price of  $^{235}\text{U}$  (93% enriched):

$$C_{\text{U-5}} = 0.400 C_{\text{U}_3\text{O}_8} + 0.236 C_{\text{SWU}} \quad \$/\text{gr} \quad (3-4)$$

Note that in the unit price correlation for fissile material,  $C_{U_3O_8}$  and  $C_{SWU}$  are the time-zero prices of ore and separative work, respectively.

For the unit prices for ore and separative work given in Table (3-2) (40 \$/lb  $U_3O_8$ , 94 \$/kg SWU), the unit prices of fissile material are:

$$C_{U-5} = 38.2 \quad \$/gr$$

$$C_{Pu} = 26.0 \quad \$/gr$$

$$C_{U-233} = 43.3 \quad \$/gr$$

As can be seen,  $^{233}U$  is the most valuable (or most expensive, depending on ones point of view) fissile material. This was to be expected, since in addition to U-233 having the best neutronic properties in the thermal and epithermal range (which justifies a higher value) the  $^{233}U$  producer reactor uses more ore and separative work than the plutonium producer reactor (note that  $V_f/V_m$  for each coupled cycle is at the optimum value).

As ore prices increase, the unit price of fissile material will also increase. Since escalation has been considered only for ore prices, in Equation (3-14) the only factors which will change, are  $G_o^P|_{ch}$  and  $G_o^P|_{dis}$  which, in turn, changes the value of  $\alpha$  in (3-22). The variation of  $\alpha$  with escalation rate is shown in Figure (3-17). A least squares fit gives

$$\alpha_{Pu} = 0.560 e^{0.12y} \tag{3.25}$$

$$\alpha_{U-233} = 0.663 e^{0.10y} \tag{3.26}$$

where  $y$  is the unit price escalation rate for ore in %/yr.

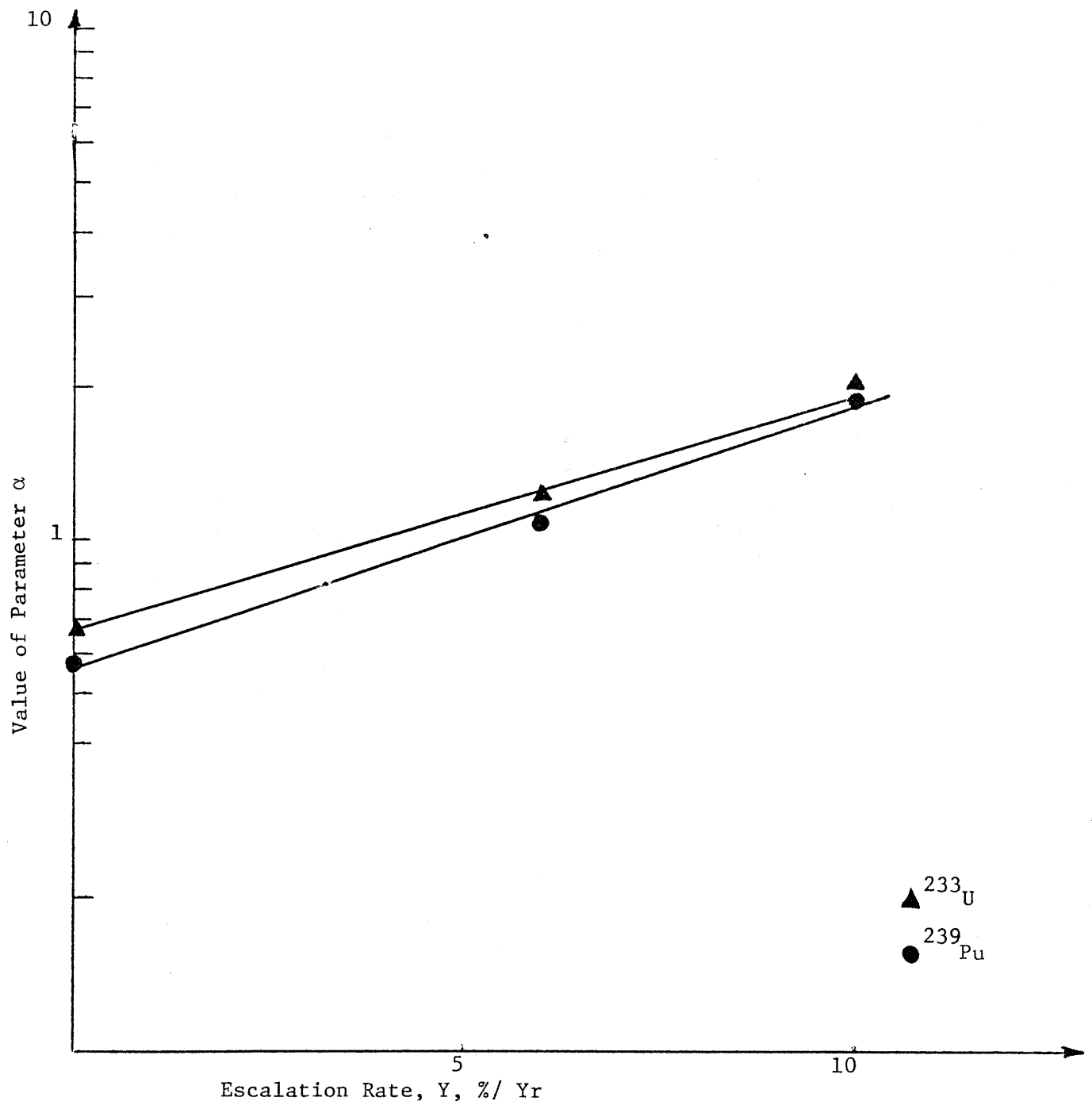

Figure 3.17 Variation of  $\alpha$  with Escalation Rate



Using Equation (3.25) and (3.26) in Equations (3.23) and (3.24), there results

$$C_{\text{Pu}} = 0.560 e^{0.12y} C_{\text{U}_3\text{O}_8}(\text{o}) + 0.178 C_{\text{SW}}(\text{o}) - 13.9 \text{ \$/gr} \quad (3.27)$$

and

$$C_{\text{U-3}} = 0.663 e^{0.10y} C_{\text{U}_3\text{O}_8}(\text{o}) + 0.318 C_{\text{SW}}(\text{o}) - 13.72 \text{ \$/gr} \quad (3.28)$$

$$0 \text{ \%/yr} \leq y \leq 10\text{ \%/yr}$$

As can be seen from Equations (3.27) and (3.28),  $C_{\text{Pu}}$  increases faster than  $C_{\text{U-3}}$  as the ore price escalation rate increases.

For other cases, using the data given in Appendix E and Table (3-2) the constants in Equation (3.22) can be found for any other combination of producer and consumer reactors. Table (3-8) shows values of  $\alpha$ ,  $\beta$ ,  $\tau$  for Pu and  $^{233}\text{U}$  for the cases where both producer and consumer reactors have the same  $V_f/V_m$ .

TABLE 3-8

VALUES\* OF  $\alpha$ ,  $\beta$ ,  $\tau$  FOR Pu AND  $^{233}\text{U}$ 

$V_f/V_m$ Producer	$V_f/V_m$ Consumer	Fissile Pu			$^{233}\text{U}$		
		$\alpha$	$\beta$	$\tau$	$\alpha$	$\beta$	$\tau$
0.3381	0.3381	0.608	0.189	-15.550	0.644	0.302	-12.580
0.4816	0.4816	0.578	0.178	-13.72	0.655	0.308	-13.183
0.9161	0.9161	0.335	0.116	- 8.172	0.725	0.339	-13.171
1.497	1.497	0.441	0.167	- 7.509	0.878	0.408	-12.001

\*These values yield the unit price of Pu and  $^{233}\text{U}$  in \$/gr

### 3.7 $^{235}\text{U}/^{232}\text{Th}$ Units Coupled to $^{233}\text{U}/^{232}\text{Th}$ Units (non segregated)

In the previous economic analyses of  $^{235}\text{U}/\text{Th}$ : $^{233}\text{U}/\text{Th}$  systems it was assumed that  $^{233}\text{U}$  and  $^{235}\text{U}$  can be segregated from each other. Thus discharged  $^{233}\text{U}$  was used to feed the  $^{233}\text{U}/\text{Th}$  cycle and  $^{235}\text{U}$  was recycled back to the  $^{235}\text{U}/\text{Th}$  cycle, and hence credit for ore, conversion and separative work were considered. Here we will look at the problem in another way and assume that separation of  $^{233}\text{U}$  and  $^{235}\text{U}$  in discharged fuel from  $^{235}\text{U}/^{232}\text{Th}$  units is not possible (see Figure (3-1a)). For the economic analyses of the nonsegregated case the discharged fissile material from the producer reactor is a mixture of isotopes. Discharged  $^{235}\text{U}$  and  $^{233}\text{U}$  masses were added together, and subsequent analysis based use of this standard fissile mixture in subsequent transactions. It should be noted that the weight fraction of  $^{233}\text{U}$  in discharged fuel from the  $^{233}\text{U}/\text{Th}$  units is higher than in charged fuel. Therefore based only on this factor the discharged mixture of isotopes from this unit can be more valuable than the high  $^{235}\text{U}$  feed mixture. However, the high  $^{235}\text{U}$  content in the fuel charged to the consumer reactor means that the production of  $^{236}\text{U}$  is significant. The presence of  $^{236}\text{U}$ , which is a neutron poison decreases the value of the discharged fissile material. Thus, we assumed that the increased value of discharged fissile material due to the increased weight percent of  $^{233}\text{U}$  is offset by the higher content of  $^{236}\text{U}$ , and the same value was considered for both charged and discharged fissile material.

Although the composition of fuel charged to the  $^{233}\text{U}/\text{Th}$  units for the non-segregated case differs from that in the segregated case the consumer reactor mass balance given in Table (D-4) for the segregated

case was re-employed; this assumption favors the non-segregated system. Thus, using the data given in Tables (D-3) and (D-4) and economic data from Table (3-2), the overall levelized fuel cycle cost corresponding to the indifference value of fissile material (the mixture of  $^{235}\text{U}$  and  $^{233}\text{U}$ ) can be obtained. Figure (3-18) shows the fuel cycle cost of  $^{235}\text{U}/\text{Th} : ^{233}\text{U}/\text{Th}$  (non segregated) versus fuel-to-moderator volume ratio. As can be seen when both producer and consumer reactor have the same  $V_f/V_m$ , the minimum fuel cycle cost is at  $V_f/V_m$  equal to 0.6, the same fuel-to-moderator volume ratio for the segregated case. However, the minimum fuel cycle cost occurs when producer and consumer reactors have  $V_f/V_m$  equal to 0.4816 and 0.9161 respectively. Comparison of Figure (3-18) and Figure (3-8) reveals that the minimum fuel cycle cost for the segregated case is only very slightly lower than for the non segregated case. However, for tight-lattice pitch, where both producer and consumer reactors have the same  $V_f/V_m$ , the fuel cycle cost for the non-segregated case is smaller than for the segregated case, and in general for non-segregated recycle the fuel cycle cost depends only weakly on the variation of  $V_f/V_m$ , whereas for the segregated case it is more sensitive to this variation.

Perhaps the most significant conclusion, however, is that near their respective optima, the segregated and non-segregated fuel cycles have costs, mills/kwhre, which differ by less than 2%. Thus our comparisons should not be biased by our use of the hard-to-implement segregated cycle as the base case for our comparisons. There is a clear need, however, for more detail examination of both modes of operation to properly assess penalties for variation in the isotopic composition of all fuel streams involved. This is left for future work.

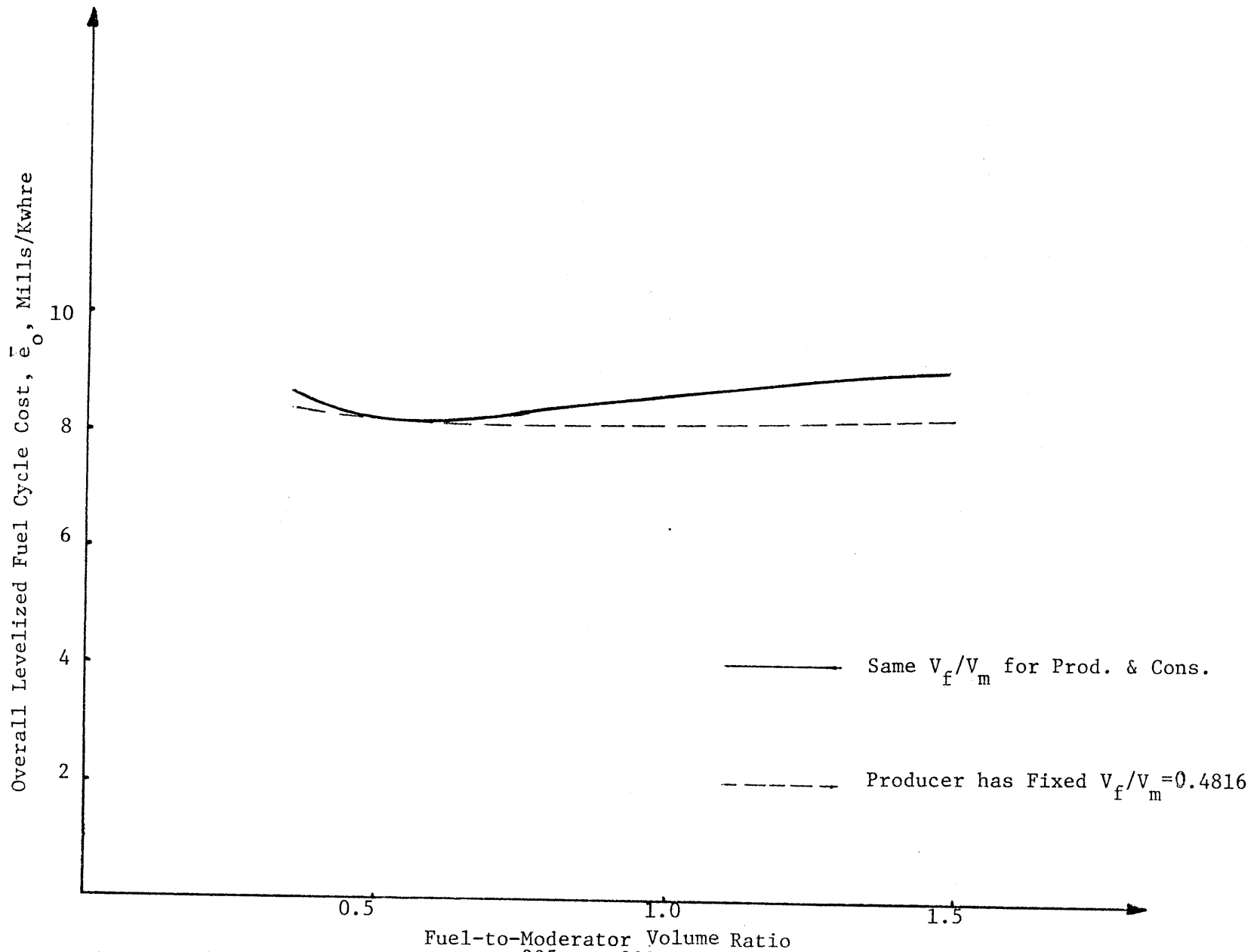

Figure 3.18 Fuel Cycle Cost of the  $^{235}\text{U}/\text{Th}:\text{}^{233}\text{U}/\text{Th}$  System (non-segregated) versus Fuel-to-Moderator Volume Ratio

### 3.8 Summary and Conclusions

In this chapter the effect of fuel-to-moderator volume ratio on the economics of coupled fuel cycles has been studied. The Maine Yankee reactor was selected as a representative reactor and the SIMMOD Code, described in Chapter 2, was employed for calculation of levelized fuel cycle costs. The coupled fuel cycles which have been studied are  $^{235}\text{U}/\text{U}$  systems coupled to Pu/U systems and  $^{235}\text{U}/\text{Th}$  systems coupled to  $^{233}\text{U}/\text{Th}$  systems. The latter combination was considered for both segregated recycle (where  $^{233}\text{U}$  can be separated from  $^{235}\text{U}$  in fuel discharged from the  $^{235}\text{U}/\text{Th}$  unit and non-segregated recycle (where the mixture of  $^{235}\text{U}$  and  $^{233}\text{U}$  discharged from the  $^{235}\text{U}/\text{Th}$  units is fed to the  $^{233}\text{U}/\text{Th}$  reactor). The Uranium once-through or throw-away fuel cycle was also considered as a reference case.

The economic analysis was based on use of the indifference value of fissile material, that is, the unit price for fissile material which makes the fuel cycle costs of the reactor producing the fissile material and that consuming the fissile material equal. By application of the definition, correlations for the unit price of fissile Pu and  $^{233}\text{U}$  were also derived. These correlations (where all units in the coupled fuel cycle are at their system optimum fuel-to-moderator volume ratio) are;

$$C_{\text{Pu}} = 0.560 e^{0.12y} C_{\text{U}_3\text{O}_8}(\text{o}) + 0.178 C_{\text{SWU}}(\text{o}) - 13.9 \text{ \$/gr} \quad (3.27)$$

$$C_{\text{U-3}} = 0.663 e^{0.10y} C_{\text{U}_3\text{O}_8}(\text{o}) + 0.318 C_{\text{SW}}(\text{o}) - 13.72 \text{ \$/gr} \quad (3.28)$$

where  $y$  = annual rate of increase in ore price, %/yr.

In the subject analysis the unit prices of all steps in the fuel cycle, except for the purchase of or credit for ore, were held constant, and numerical values were selected from the recent AIF study (A-2) for the uranium fuel cycle. Values for other fuel cycles were developed from the literature, primarily References (K-2) and (A-3). In the economic analysis a deflated discount rate has been used, and constant dollar values were used for all transactions.

The effect of ore price variation was considered in three different ways, (a) applying a scarcity related escalation rate but holding the time zero cost constant, (b) changing the time-zero cost of ore in a stepwise fashion without further escalation (c) changing both the time-zero cost of ore and the escalation rate, in accord with the model developed by Gharamani (G-2). The time-zero cost of ore in the third case is an extrapolated time-zero cost, which is different for each scenario.

The results developed in this manner shows that:

1. The optimum fuel-to-moderator volume ratio for both the  $^{235}\text{U}/\text{U}:\text{Pu}/\text{U}$  system and the  $^{235}\text{U}/\text{U}$  once-through fuel cycle is approximately 0.5 (which is close to current design values of typical PWR cores such as the Maine Yankee reactor) for the  $^{235}\text{U}/\text{Th}:\text{}^{233}\text{U}/\text{Th}$  systems the optimum  $V_f/V_m$  is higher : about 0.6.
2. Keeping the fuel-to-moderator volume ratio of the producer reactor constant results in an overall levelized fuel cycle cost which is insensitive to variation of the  $V_f/V_m$  of the consumer reactor.

3. When  $V_f/V_m$  for both the  $^{235}\text{U}/\text{U}$  units and the Pu/U units is equal to 0.4816 the system fuel cycle cost has the lowest value among any other combinations (6.19 mills/kwhre).
4. When  $V_f/V_m$  is equal to 0.4816 and 0.9161 for the  $^{235}\text{U}/\text{Th}$  and  $^{233}\text{U}/\text{Th}$  units (with segregated recycle) respectively, the fuel cycle cost has the lowest value among any other combinations for this system (8.03 mills/kwhre)
5. The minimum fuel cycle cost of once-through fuel cycle at its optimum fuel-to-moderator volume ratio is 6.06 mills/kwhre (for federal disposal of discharged fuel. Disposal and storage of discharged fuel will increase the minimum fuel cycle cost by 5%).
6. The ore price escalation rate has no appreciable effect on the optimum fuel-to-moderator volume.
7. If the coupled systems are evaluated for the same number of steady state batches, the  $^{235}\text{U}/\text{U}:\text{Pu}/\text{U}$  combination is more sensitive to variation of the scarcity related escalation of ore price than the  $^{235}\text{U}/\text{Th}:\text{^{233}U}/\text{Th}$  combination for both segregated and non-segregated recycle. When the  $^{235}\text{U}/\text{U}:\text{Pu}/\text{U}$  and  $^{233}\text{U}/\text{Th}:\text{Pu}/\text{U}$  combinations are each at their respective optimum fuel-to-moderator volume ratios, the  $^{235}\text{U}/\text{U}:\text{Pu}/\text{U}$  system is better than  $^{235}\text{U}/\text{Th}:\text{^{237}U}/\text{Th}$  system for ore scarcity-related escalation rates less than 8%/yr. Below a 5.5%/yr escalation rate for ore price the once-through uranium cycle is less expensive than the  $^{235}\text{U}/\text{Th}:\text{^{233}U}/\text{Th}$  cycle. However, the once-through cycle has no advantage over the  $^{235}\text{U}/\text{U}:\text{Pu}/\text{U}$  system under the equal burnup constraint imposed up to this point.



8. When the coupled reactors are assumed to have equal lifetime (same  $Nt_c$ ) at their optimum fuel-to-moderator volume ratio, the  $^{235}\text{U}/\text{U}:\text{Pu}/\text{U}$  system is the most attractive system for the entire range of escalation rates examined.
9. The  $^{235}\text{U}/\text{Th}:\text{}^{233}\text{U}/\text{Th}$  combination with segregated recycle is only slightly more favorable than the non-segregated case in the vicinity of the optimum fuel-to-moderator volume ratio; but as the escalation rate for the price of ore increases, the difference becomes more appreciable. Therefore since the non-segregated case is the more realistic option, the overall outlook for the  $^{235}\text{U}/\text{Th}:\text{}^{233}\text{U}/\text{Th}$  system is diminished.
10. However using different time-zero costs for ore prices (note that this time-zero cost of ore is an extrapolated time-zero cost and is a function of annual ore usage which varies for each combination of producer and consumer reactors) makes the situation better for the  $^{235}\text{U}/\text{Th}:\text{}^{233}\text{U}/\text{Th}$  combinations, especially when the escalation rate of ore prices is also increased.

The most significant conclusion of the work reported so far is that today's producer reactors are very nearly at their optimum fuel-to-moderator volume ratio. Furthermore, to first order, optimization of the fuel cycle either to minimize ore usage or to minimize overall fuel cycle cost are roughly comparable courses of action.

This work has also identified the need for additional refinement in several regards - in particular, more attention must be paid to assignment of cost as a function of composition and to realistic treatment of the re-enrichment vs. blending option for recycle of mixed uranium isotopes. In addition all of

the work in this chapter was for fixed burnup (33,000 MWD/MTHM):  
optimization of this parameter is clearly a desirable further goal.

The chapter which follows will address a number of these additional considerations.

## CHAPTER 4

## ECONOMIC ANALYSIS OF PWR CORE DESIGN AND FUEL MANAGEMENT

## 4.1 Introduction

Decreasing the annual ore usage of PWRs on the once-through fuel cycle by increasing the discharged burnup is a widely recognized stratagem. Fujita (F-3) for example, has shown that significant ore saving ( $\sim 20\%$ ) are obtained if the discharged burnup can be doubled (to  $\sim 60000$  MWD/MTHM). Achieving this goal will of course require considerable attention to fuel pin design and materials technology: topics not addressed here, since we are more concerned with development of the economic motivation for pursuing this goal.

In this chapter we study the effect of increasing discharged burnup on the fuel cycle cost of PWRs for both once-through and recycling modes; and determine the optimum discharged burnup, where the fuel cycle cost is minimum. Since the fuel cycle cost is one-quarter to one-third of the busbar cost, busbar and total system costs (where the cost of replacement energy must be considered) are also studied briefly.

Going to very high discharged burnups (or tight pitch lattices) may favor stainless steel clad over zircaloy clad. Therefore the impact of using stainless steel in the core on the fuel cycle cost of the PWR is examined.

While burnup variation is the main theme underlying all of the sections of this chapter, as will be seen, a number of other points will be brought out in the course of the presentation.

## 4.2 Allowing for the Presence of $^{236}\text{U}$ in Discharged Fuel

### 4.2.1 A Blending Method

The uranium fuel cycles which are considered in this chapter have two important variations: the once-through mode, which is in effect at the present time, and the recycling mode. For the first mode no credits are considered for discharged fuel, and discharged fuel is disposed of or stored for future use. However credits exist for the second mode due to the presence of fissile plutonium and uranium; the weight fraction of  $^{235}\text{U}$  in spent fuel is usually greater than 0.00711 (natural uranium), and always greater than typical separation plant tails assay ( $\sim 0.002$ ), and it is thus worth re-enrichment. However, during irradiation of the fuel, other isotopes are created in it, one of the most important being  $^{236}\text{U}$ .  $^{236}\text{U}$  has a large capture cross section, is not readily fissionable (nor are its immediate transmutation/decay products) and hence behaves as a poison. The separation of  $^{236}\text{U}$  from  $^{235}\text{U}$  is not possible chemically, and thus the uranium recycled to the reactor has to have a higher  $^{235}\text{U}$  enrichment to compensate for the negative reactivity due to the presence of  $^{236}\text{U}$ .

The enrichment of reprocessed uranium can be increased using one of two methods. In the first method reprocessed uranium can be enriched by conversion to  $\text{UF}_6$  and using a diffusion or centrifuge plant. In the second method, the reprocessed uranium can be blended with unirradiated uranium of sufficient enrichment to produce a product having the desired enrichment. Each method has some advantages (G-4).

In the blending method, since no recycled uranium is to be re-enriched in a diffusion plant, no conversion of uranium to  $\text{UF}_6$  is necessary and the additional complications due to the presence of  $^{236}\text{U}$  in a separations cascade can be avoided.

Another advantage of blending is associated with production of  $^{237}\text{Np}$ .  $^{237}\text{Np}$  is the precursor of  $^{238}\text{Pu}$  which has been developed for many isotope applications;  $^{237}\text{Np}$  in turn is obtained by irradiation of  $^{236}\text{U}$ . In the blending method all  $^{236}\text{U}$  can be recycled to the reactor and irradiated for production of  $^{237}\text{Np}$ . The disadvantages of blending are associated with the fact that, as the concentration of  $^{236}\text{U}$  in the fuel charge increases, the requirement for additional fissile material increases. More separative work is also needed for the enrichment of the fresh uranium which is to be used for blending.

In this section we will discuss the blending method. Re-enrichment of recycled uranium will be discussed in the next section. Figure (4-1) shows the schematic diagram for the blending method. The weight fractions of  $^{235}\text{U}$  and  $^{236}\text{U}$  at each stage, have been labeled by subscripts R, E, F and P, denoting recycle, enriched feed to diffusion plant, tails assay of the diffusion plant, and output of the blending step, respectively. In accordance with the preceding discussion  $Z_F$ ,  $Z_E$  and  $Z_W$  are equal to zero.

The object is to blend R Kg of reprocessed uranium with E Kg of enriched uranium so that the mixture has  $Y_p$  weight fraction of  $^{235}\text{U}$  and  $Z_p$  weight fraction of  $^{236}\text{U}$ . At this point we assume the  $Y_p$  should be equal to the feed enrichment of the reactor when  $Z_p$  is equal to zero. However, since a fraction  $Z_p$ , of  $^{236}\text{U}$  remains in the charged fuel,  $Y_p$  has to be increased by  $\Delta Y_p$ , where  $\Delta Y_p$  is the extra enrichment needed to compensate for the negative reactivity due to the presence of  $^{236}\text{U}$ . In Appendix E it is shown that  $\Delta Y_p$  is proportional to  $Z_p$ , that is:

$$\Delta Y_p = 0.2 (Z_p) \quad (4.1)$$

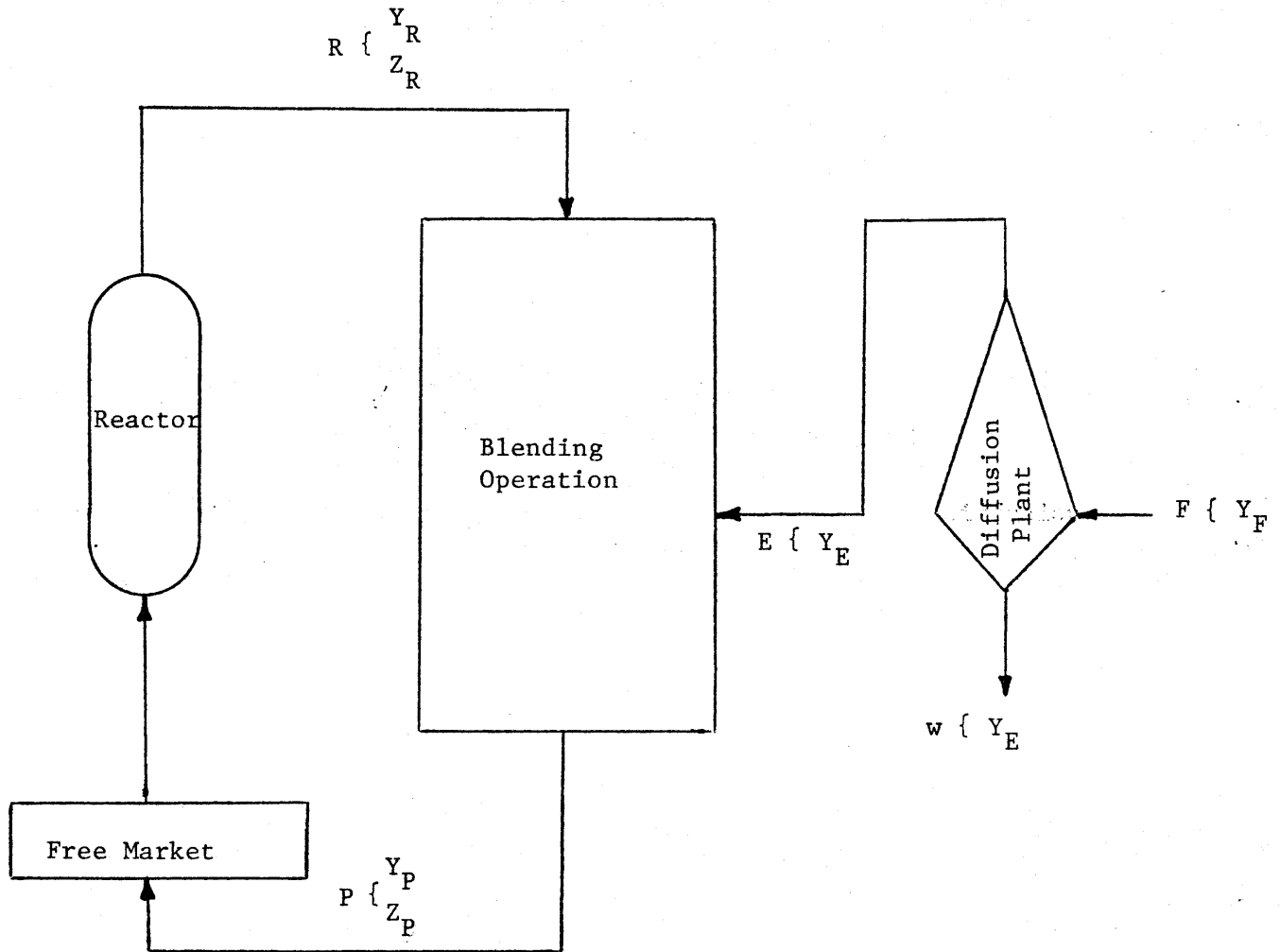

## Key:

$R$  = Kg uranium discharged from the reactor

$E$  = Kg enriched uranium, used for blending

$P$  = Kg blended uranium

$F$  = Kg natural uranium fed to enrichment plant

$W$  = Kg depleted uranium, enrichment plant tails

$Y$  = weight fraction of  $^{235}\text{U}$

$Z$  = weight fraction of  $^{236}\text{U}$

Figure 4.1 Recycling of Uranium Using the Blending Method

Expressions similar to Equation (4.3) have been found by other investigators (H-2), (G-6).

Imposing the conservation of mass one can write

$$P = R + E \quad (4.2)$$

$$Y_P + \Delta Y_P = \frac{R \cdot Y_R + E \cdot Y_E}{R + E} \quad (4.3)$$

$$Z_P = \frac{R \cdot Z_R}{R + E} \quad (4.4)$$

Solving Equations (4.3) and (4.4) for  $Y_E$  and  $E$ , respectively, gives:

$$Y_E = \left( \frac{Y_P - Y_R}{Z_R - Z_P} \right) Z_P + Y_P + \Delta Y_P \left( \frac{Z_R}{Z_R - Z_P} \right) \quad (4.5)$$

$$Z_P \neq 0, Z_R$$

$$E = \left( \frac{Z_R}{Z_P} - 1 \right) R \quad (4.6)$$

By using Equation (4.1) in (4.5) there results:

$$Y_E = \left( \frac{Y_P - Y_R}{Z_R - Z_P} \right) \cdot Z_P + Y_P + K \left( \frac{Z_P - Z_R}{Z_R - Z_P} \right) \quad (4.7)$$

$Y_P$  and  $Z_R$  are always greater than  $Y_R$  and  $Z_P$  respectively. Hence, according to Equation (4.7)  $Y_E$  is always greater than  $Y_P$ .

Using Equations (4.6) and (4.7), the quantity of natural uranium required for blending can be found,

$$F = E \left( \frac{Y_E - Y_W}{0.00711 - Y_W} \right) \quad (4.8)$$

For calculating the credit for uranium discharged from the reactor it should be noted that in the output of the blending step there are P Kg of uranium with  $(Y_P + \Delta Y_P)$  and  $Z_P$  weight fraction of  $^{235}\text{U}$  and  $^{236}\text{U}$  respectively, which can be considered equivalent to  $Y_P$  weight fraction of  $^{235}\text{U}$  in the absence of  $^{236}\text{U}$ .

The net credit from discharged uranium can be obtained as:

$$\left( \begin{array}{l} \text{The Net Credit for} \\ \text{Discharged Uranium} \end{array} \right) = \left( \begin{array}{l} \text{The revenue from} \\ \text{sale of P Kg of} \\ \text{uranium with } Y_P \\ \text{weight fraction } ^{235}\text{U} \end{array} \right) - \left( \begin{array}{l} \text{Total} \\ \text{Expenses} \end{array} \right)$$

$$\text{TC} = \text{RU} - \text{TE} \quad (4.9)$$

The revenue from the sale of P Kg of uranium with  $Y_P$  weight fraction of  $^{235}\text{U}$ , RU, and Total Expenses, TE, can be calculated from;

$$\text{RU} = 2.6 M_P C_{\text{U}_3\text{O}_8} + \left(\frac{S}{P}\right)_P PC_{\text{SWU}} + M_P \cdot C_{\text{UF}_6} \quad (4.10)$$

$$\text{TE} = 2.6 F C_{\text{U}_3\text{O}_8} + \left(\frac{S}{P}\right)_E EC_{\text{SWU}} + FC_{\text{UF}_6} \quad (4.11)$$

where:

$$M_P = P \cdot \left( \frac{Y_P - Y_W}{0.00711 - Y_W} \right) = (R + E) \cdot \left( \frac{Y_P - Y_W}{0.00711 - Y_W} \right) \quad (4.12)$$

$$\begin{aligned} \left(\frac{S}{P}\right) &= (2Y_i - 1) \ln \left( \frac{Y_i}{1 - Y_i} \right) + \left( \frac{Y_i - 0.00711}{0.00711 - Y_W} \right) (2y_{W-1}) \ln \left( \frac{Y_W}{1 - Y_W} \right) \\ &- 4.87 \left( \frac{Y_i - Y_W}{0.00711 - Y_W} \right) \quad i = P \text{ or } E, \text{ as appropriate} \end{aligned} \quad (4.13)$$



$C_{U_3O_8}$ ,  $C_{SW}$  and  $C_{UF_6}$  are the ore unit price in \$/lb, the separative work price in \$/Kg SWU, and the conversion of uranium to  $UF_6$  cost in \$/Kg HM respectively. These costs are as of the time when the fuel is discharged from the reactor. Defining

$$M_{net} = M_P - F \quad (4.14)$$

and

$$S_{net} = \left(\frac{S}{P}\right)_P \cdot P - \left(\frac{S}{P}\right)_E \cdot E \quad (4.15)$$

then the net credit can be written as

$$TC = 2.6 C_{U_3O_8} M_{net} + C_{SWU} : S_{net} + C_{UF_6} \cdot M_{net} \quad (4.16)$$

Using Equations (4.8) and (4.12) in Equation (4.14) and using 0.2 w/o for the tails assay of the diffusion plant:

$$M_{net} = \frac{1}{0.00511} [R(Y_P - 0.002) + E(Y_P - Y_E)] \quad (4.17)$$

The quantity  $(Y_P - Y_E)$  can be found from Equation (4.7), and Equation (4.8) can be used for E; then  $M_{net}$  can be written as

$$M_{net} = \frac{R}{0.00511} [Y_R - 0.002 - K \cdot Z_R] \quad (4.18)$$

Equation (4.18) indicates that  $M_{net}$  depends only on the characteristics of the discharged fuel, and it is independent of  $Z_P$  and  $Y_P$ . Similarly Equation (4.15) can be written:

$$S_{\text{net}} = \left(\frac{S}{P}\right)_P \cdot R + \left[\left(\frac{S}{P}\right)_P - \left(\frac{S}{P}\right)_E\right]E \quad (4.19)$$

Using Equation (4.13) gives;

$$\left(\frac{S}{P}\right)_P - \left(\frac{S}{P}\right)_E = (2Y_P - 1)\ln \frac{Y_P}{1 - Y_P} - (Y_E - 1)\ln \frac{Y_E}{1 - Y_E} + 256.0(Y_P - Y_E) \quad (4.20)$$

Substituting Equation (4.20) in Equation (4.19) and employing the expressions for E and  $(Y_P - Y_E)$  from Equation (4.6) and (4.7) respectively, one can write

$$S_{\text{net}} = \left(\frac{S}{P}\right)_P \cdot R + E(2Y_P - 1)\ln \frac{Y_P}{1 - Y_P} - E(2Y_E - 1)\ln \frac{Y_E}{1 - Y_E} - 256.0 R(Y_P - Y_R + KZ_R) \quad (4.21)$$

Note that  $Y_E$  cannot be greater than 1.0. Thus from Equation (4.7),  $Z_P$  cannot be greater than,  $Z_{P_{\text{max}}}$  where

$$Z_{P_{\text{max}}} = Z_R \cdot \left( \frac{1 - Y_P}{1 - Y_R + KZ_R} \right) \quad (4.22)$$

Also, TC, the total net credit must be greater than zero to make it worth using the blending method. Hence by employing Equation (4.16);

$$(2.6 C_{U_3O_8} + C_{UF_6})M_{\text{net}} + C_{\text{SWU}} \cdot S_{\text{net}} \geq 0 \quad (4.23)$$

All parameters for a given batch of recycled uranium are constant, and do not depend on  $Z_P$  except  $S_{\text{net}}$ , thus

$$S_{\text{net}} \geq - \left[ \frac{2.6 C_{\text{U}_3\text{O}_8} + C_{\text{UF}_6}}{C_{\text{SWU}}} \right] M_{\text{net}} \quad (4.24)$$

$M_{\text{net}}$ ,  $S_{\text{net}}$  and  $R$  can be used in SIMMOD to characterize the back end credit of the uranium recycle mode. It should be noted that since the blended uranium charged to the reactor has  $Z_p$  weight fraction of  $^{236}\text{U}$ , the weight fraction of  $^{236}\text{U}$ ,  $Z_R$ , in discharged fuel is greater than when fresh fuel is charged to the reactor; thus even more fresh uranium is needed to hold the fraction of  $^{236}\text{U}$  at  $Z_p$  in uranium recycled to the reactor. On the other hand, some fraction of the  $^{236}\text{U}$  charged to the reactor is burned and becomes  $^{237}\text{Np}$ , which, not only reduces the concentration of  $^{236}\text{U}$  in the core, but after reprocessing of discharged fuel,  $^{237}\text{Np}$  can be separated chemically and sold. Consequently there is a credit due to sale of  $^{237}\text{Np}$ . Here we will in effect (by ignoring both effects) assume that the credit due to sale of  $^{237}\text{Np}$  compensates for the extra expenses of additional fresh fuel ( $\Delta E$ ) to keep the weight fraction of  $^{236}\text{U}$  in the recycled uranium charged to the reactor constant.

In the above equations  $Z_p$  can be selected to be between 0 and  $Z_p$ . However a small  $Z_p$  means a large amount of ore is required for blending, and the choice of a value of  $Z_p$  near  $Z_R$  means that a large amount of separative work is needed. For a three batch core (Maine Yankee) and a feed enrichment equal to 3.0 w/o the compositions of discharged fuel given in Table (D-6) were used to calculate the net credit, TC, due to discharged uranium. The results showed that TC is negative for all values of  $Z_p$ , and consequently the blending method is not attractive. However, for the same core but with 1.5 w/o feed enrichment (again see Table (D-6) for the discharged composition), TC versus  $Z_p$  was found to be as shown in Figure (4-2). As

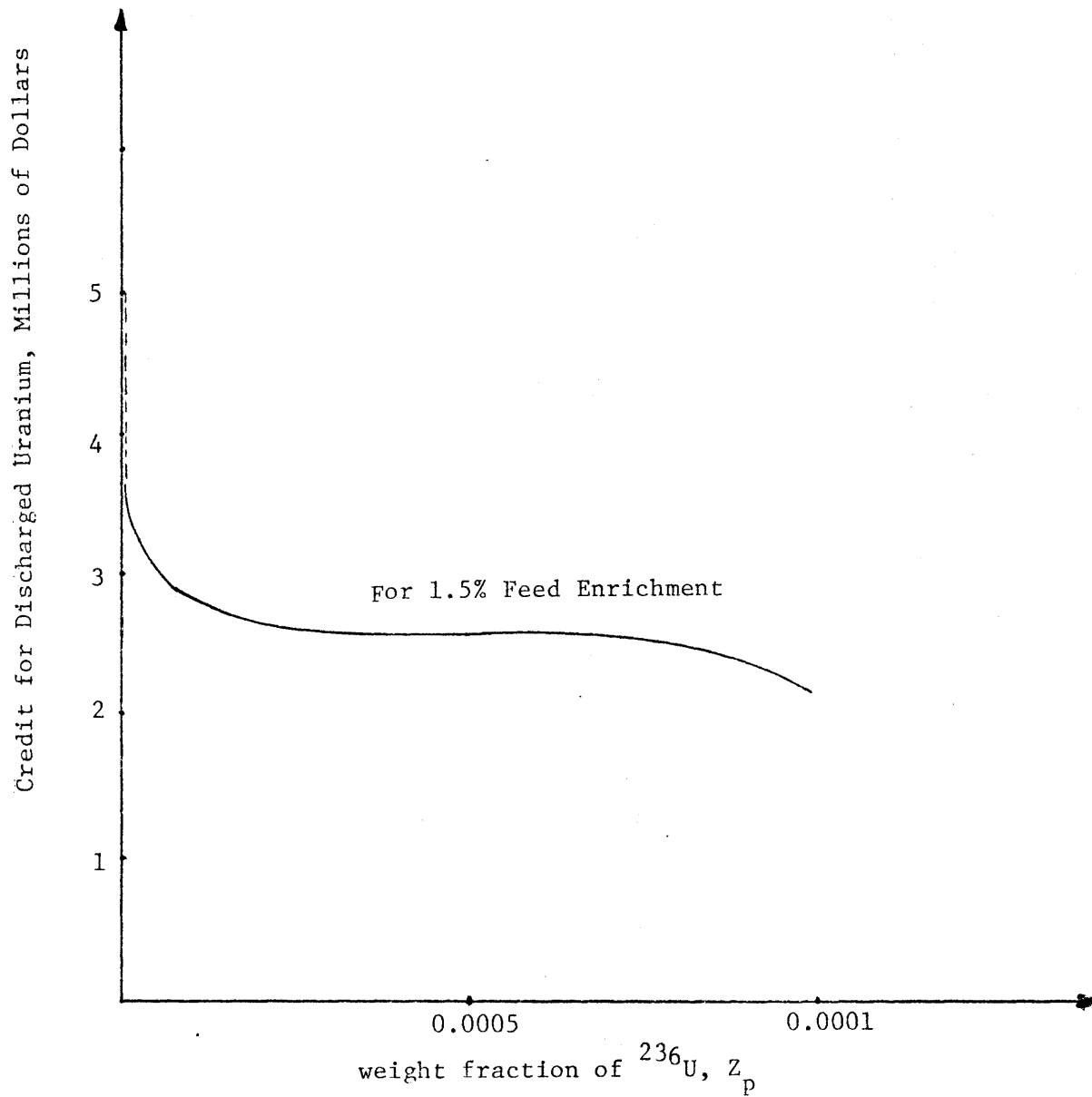

Figure 4.2 Variation of Net Credit for Discharged Fuel with the Weight per cent of  $^{236}\text{U}$  in the Fuel Fed to the Reactor

can be seen, the net credit is almost constant between 0.0001 and 0.001 weight fraction of  $^{236}\text{U}$  charged to the reactor. Thus it can be said that using the blending method to achieve a specific weight per cent of  $^{236}\text{U}$  in the output of the blending operation is attractive only for low discharged burnup.

Another way to use the blending method is to blend R Kg of recycled uranium with E Kg of enriched fresh fuel to obtain P Kg of blended uranium with  $Y_P + \Delta Y_P$  weight fraction of  $^{235}\text{U}$  and  $Z_P$  weight fraction of  $^{236}\text{U}$ . Again  $\Delta Y_P$  is the increase in enrichment due to the presence of  $Z_P$  weight fraction of  $^{236}\text{U}$ . Now instead of assuming a value of  $\phi$  for  $Z_P$  (as before) we assume that P and  $Y_P$  should be equal to the heavy metal per batch charged to the reactor and the weight fraction of  $^{235}\text{U}$  in charged fuel (when there is no  $^{236}\text{U}$ ), respectively. Thus in (4.2) through (4.4), P,  $Y_P$ , R and  $Z_P$  are known and  $Z_{P,E}$  and  $Y_E$  are unknown. Solving these equations for  $Z_P$ , E and  $Y_E$ :

$$E = (1 - \phi)P \quad (4.25a)$$

$$Z_P = \phi \cdot Z_R \quad (4.25b)$$

$$Y_E = \frac{Y_P + K\phi(Z_R - Y_R)}{1 - \phi} \quad (4.25c)$$

where

$$\phi = R/P$$

Again at the output of the blender we have P Kg of uranium with  $Y_P + \Delta Y_P$  ( $\Delta Y_P = 0.2 Z_P$ ) weight fraction of  $^{235}\text{U}$  and  $Z_P$  weight fraction of  $^{236}\text{U}$  which is equivalent to P Kg of uranium with  $Y_P$  weight fraction of  $^{235}\text{U}$  in the

absence of  $^{236}\text{U}$ . The net credit can also be written as before, that is,

$$\text{TC} = 2.6 C_{\text{U}_3\text{O}_8} M'_{\text{net}} + C_{\text{SWU}} S_{\text{net}} + C_{\text{UF}_6} M'_{\text{net}} \quad (4.26)$$

where,

$$M'_{\text{net}} = \left[ \frac{(Y_P - Y_E) + \phi(Y_E - Y_W)}{0.00511} \right] P \quad (4.27)$$

and  $S_{\text{net}}$  is given by Equation (4.21)

For a three-batch core and a feed enrichment equal to 3.0 w/o (see Table (D-6)) the net credit due to discharged uranium is again negative, ( $-5.7 \times 10^6$  \$). It should be noted that even if we assume that  $Z_R$ , the weight fraction of  $^{236}\text{U}$  in discharged fuel, is zero the credit with the blending method is negative. For example, using the above method, for the 3 batch core the net credit is  $-4.7 \times 10^6$  \$ when  $Z_R$  is equal to zero. Thus the presence of  $^{236}\text{U}$  penalizes the credit an additional 21%. These results show that the blending method is not an attractive method and it can be used only for low burnup where the charged enrichment is low and the weight per cent of  $^{236}\text{U}$  is small. Thus for this report we consider only the re-enrichment method, as discussed in the next section, for calculation of the credit for discharged uranium.

Finally, note that credit must also be given for the discharged plutonium. This was done using the indifference method discussed in Section 3.3 of Chapter 3.

#### 4.2.2 Re-enrichment

In this section we determine the credit for discharged uranium using the re-enrichment method. That is, the discharged uranium is fed to a

diffusion (or other enrichment) plant to increase the weight per cent of  $^{235}\text{U}$  to the desired level.

Figure (4.3) shows a schematic diagram. As illustrated in this figure R Kg of discharged uranium are fed to the diffusion plant to increase the weight fraction of  $^{235}\text{U}$  from  $Y_R$  to  $Y_P + \Delta Y_P$ , where, as discussed before,  $\Delta Y_P$  is the increase in the weight fraction needed to offset the presence of  $Z_P$  weight fraction of  $^{236}\text{U}$ ;

$$\Delta Y_P = K Z_P \quad (4.1)$$

with (from LEOPARD Calculations)  $K = 0.2$ . Also, due to the presence of  $^{236}\text{U}$ , some extra separative work has to be expended to get the desired weight percent of  $^{235}\text{U}$ . In reference (G-7) this extra contribution due to  $^{236}\text{U}$  has been given as;

$$\Delta S = 4W_6 \ln \frac{Y_W}{Y_R} + 4 P_6 \ln \frac{Y_P + Y_P}{Y_R} \quad (4.28)$$

where

$\Delta S$  = extra separative work needed, KgSWU

$W_6 = W \cdot Z_W$ , Kg of  $^{236}\text{U}$  in tails

$P_6 = P \cdot Z_P$ , Kg of  $^{236}\text{U}$  in product

The ratio of the amount of  $^{236}\text{U}$  in tails to the amount of  $^{236}\text{U}$  fed to the diffusion plant can be written as (G-7)

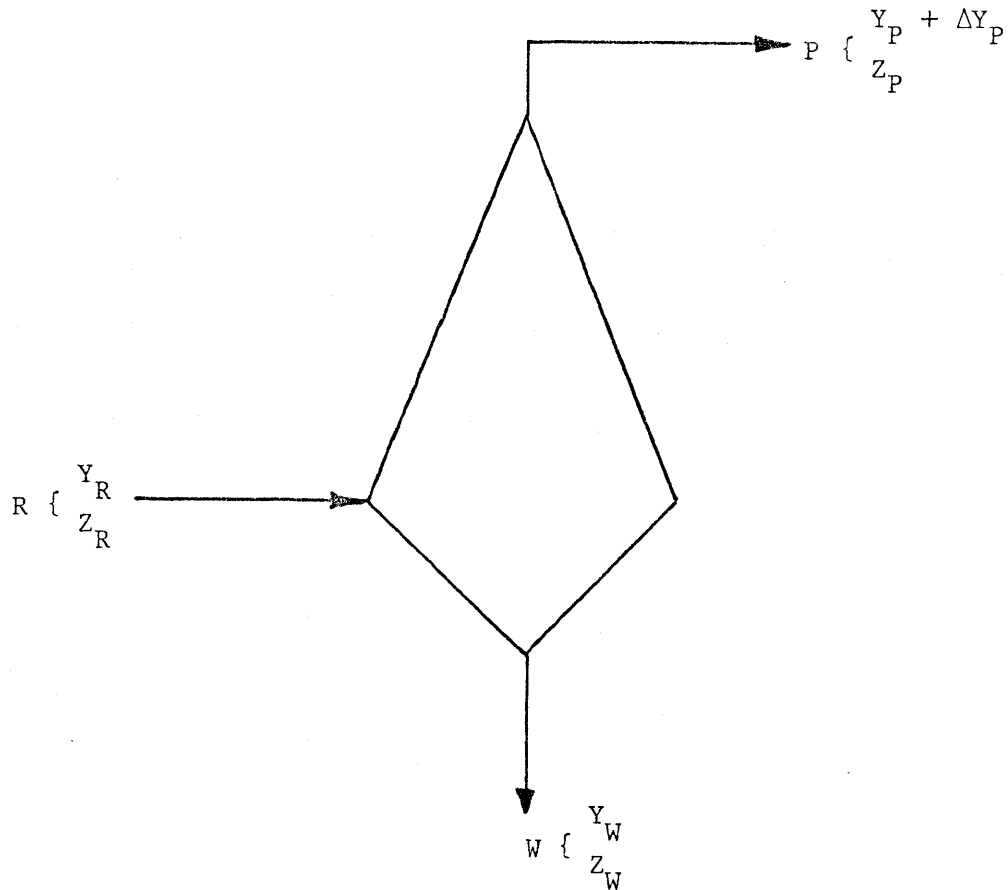

Key:

R = kg uranium discharged from the reactor

P = kg of enriched uranium

W = kg of depleted uranium

Y = weight fraction of  $^{235}\text{U}$

Z = weight fraction of  $^{236}\text{U}$

Subscripts R, P, W denote recycle, product and tails assay steps respectively.

Figure 4.3 Schematic Diagram of Re-enrichment Method



$$\frac{W_6}{R_6} = \frac{\left(\frac{1}{Y_R}\right)^{1/3} - \left(\frac{1}{Y_P + \Delta Y_P}\right)^{1/3}}{\left(\frac{1}{Y_W}\right)^{1/3} - \left(\frac{1}{Y_P + \Delta Y_P}\right)^{1/3}} \quad (4.29)$$

where

$R_6 = R \cdot Z_R$ , Kg of  $^{236}\text{U}$  in recycled uranium; using mass conservation one can write

$$R = P + W \quad (4.30a)$$

$$R \cdot Z_R = P \cdot Z_P + W_6 \quad (4.30b)$$

$$R \cdot Y_R = P \cdot (Y_P + \Delta Y_P) + W \cdot Y_W \quad (4.30c)$$

Using Equation (4.1), Equation (4.30c) can be written as

$$R \cdot Y_R = P Y_P + K \cdot P Z_P + W Y_W \quad (4.30d)$$

Solving Equations (4.30a), (4.30b) and (4.30d) simultaneously for P,  $Z_P$  and W gives:

$$P = \frac{R(Y_R - Y_W) - K(RZ_R - W_6)}{Y_P - Y_W} \quad (4.31)$$

$$Z_P = \frac{(RZ_R - W_6)(Y_P - Y_W)}{R(Y_R - Y_W) - K(RZ_R - W_6)} \quad (4.32)$$

$$W = \frac{R(Y_P - Y_R) + K(RZ_R - W_6)}{Y_P - Y_W} \quad (4.33)$$

Note that when there is no  $^{236}\text{U}$  in the uranium fed to the diffusion plant  $Z_R$  and  $W_6$  are equal to zero, and hence from Equation (4.32)  $Z_P$  is zero and the expressions given for P and W reduce to their standard form.

It should be mentioned that  $W_6$  in the above equation is itself dependent on  $\Delta Y_P$  or  $Z_P$  ( $\Delta Y_P = KZ_P$ , see Equation (4.29)). Thus a trial and error method has been used: we first estimate a value for  $Z_P$ , and then by using Equation (4.1) find  $\Delta Y_P$ , then employing Equation (4.29)  $W_6$  can be found, and hence  $Z_P$  can be calculated using Equation (4.32). If the difference between calculated and estimated values of  $Z_P$  is within acceptable limits this value of  $W_6$  can be used to calculate P and W from Equations (4.31) and (4.33), otherwise, the calculated value of  $Z_P$  is considered as the new estimate for a second iteration. This procedure is repeated until the desired difference between the new value of  $Z_P$  and the previous value of  $Z_P$  is reached. However,  $\Delta Y_P$  is small, and hence its effect on  $W_6$  is not pronounced. Thus  $W_6$  can be calculated accurately enough for most purposes by assuming  $\Delta Y_P$  is equal to zero ( $Z_P$  equals zero).

After reenrichment of the recycled uranium we have P Kg of enriched uranium with  $Y_P + \Delta Y_P$  weight fraction of  $^{235}\text{U}$  and  $Z_P$  weight fraction of  $^{236}\text{U}$ , which is equivalent to P Kg of enriched uranium with  $Y_P$  weight fraction of  $^{235}\text{U}$ , and no  $^{236}\text{U}$ . Thus the credit due to P Kg of uranium can be calculated as;

$$RU = P \left( \frac{Y_P - 0.002}{0.00511} \right) (2.6 C_{\text{U}_3\text{O}_8} + C_{\text{UF}_6}) + P \cdot \left( \frac{S}{P} \right)_P C_{\text{SWU}} \quad (4.34)$$

where parameters are defined as before and

$$\left( \frac{S}{P} \right)_P = (2Y_{P-1}) \ln \frac{Y_P}{1 - Y_P} + 6.18 \left( \frac{Y_P - 0.00711}{0.00511} \right) - 4.8 \left( \frac{Y_P - 0.002}{0.00511} \right) \quad (4.35)$$

From this revenue the expenses due to reenrichment of recycled uranium must be subtracted to get the net credit. The expenses can be calculated as,

$$TE = \left[ \left( \frac{S}{P} \right)_R P + \Delta S \right] \cdot C_{SWU} + R \cdot C_{UF_6} \quad (4.36)$$

where

$$\begin{aligned} \left( \frac{S}{P} \right)_R = & (2Y_{P-1}) \ln \left( \frac{Y_P}{1 - Y_P} \right) + \left( \frac{Y_P - Y_R}{Y_R - Y_W} \right) (2Y_{W-1}) \ln \left( \frac{Y_W}{1 - Y_W} \right) \\ & - \left( \frac{Y_P - Y_W}{Y_R - Y_W} \right) (2Y_{R-1}) \ln \left( \frac{Y_R}{1 - Y_R} \right) \end{aligned} \quad (4.37)$$

Therefore the net credit can be written

$$TC = RU - TE$$

or

$$\begin{aligned} TC = & 2.6P \left( \frac{Y_P - 0.002}{0.00511} \right) C_{U_3O_8} + \left\{ \left[ \left( \frac{S}{P} \right)_P - \left( \frac{S}{P} \right)_R \right] P - \Delta S \right\} C_{SWU} \\ & + \left[ \left( \frac{Y_P - 0.002}{0.00511} \right) P - R \right] C_{UF_6} \end{aligned} \quad (4.38)$$

Define:

$$M_{ore} = 2.6 \left( \frac{Y_P - 0.002}{0.00511} \right) P \quad (4.39)$$

$$S_{net} = \left[ \left( \frac{S}{P} \right)_P - \left( \frac{S}{R} \right)_R \right] \cdot P - \Delta S \quad (4.40)$$

and

$$M_{UF_6} = \left( \frac{Y_P - 0.002}{0.00511} \right) P - R \quad (4.41)$$

Equation (4.38) can be written

$$TC = M_{\text{ore}} C_{\text{U}_3\text{O}_8} + S_{\text{net}} \cdot C_{\text{SWU}} + M_{\text{UF}_6} C_{\text{UF}_6} \quad (4.42)$$

Using Equations (4.37) and (4.35) in Equation (4.40), and assuming  $Y_W$  is equal to 0.002,  $S_{\text{net}}$  can be written as

$$S_{\text{net}} = \left[ 6.18 \left( \frac{Y_R - 0.00711}{0.00511} \right) - 4.87 \left( \frac{Y_P - 0.002}{0.00511} \right) \right. \\ \left. + \left( \frac{Y_P - 0.002}{Y_R - 0.002} \right) (2Y_R - 1) \ln \left( \frac{Y_R}{1 - Y_R} \right) \right] P - \Delta S \quad (4.43)$$

$M_{\text{ore}}$ ,  $S_{\text{net}}$  and  $M_{\text{UF}_6}$  can be used in SIMMOD to calculate the overall levelized fuel cycle cost for the recycle mode.

For the three batch core and 3.0 w/o feed enrichment, TC, the net credit is  $3.57 \times 10^6$  \$, whereas if there is no  $^{236}\text{U}$  in the discharged fuel TC is equal to  $4.5 \times 10^6$ . That is, a 21% penalty is again incurred due to the existence of  $^{236}\text{U}$  in discharged fuel.

Finally, it should be mentioned that we have assumed the enrichment cost (\$/Kg SWU) for the recycled uranium is the same as for fresh fuel.

Determination of the enrichment cost of recycled fuel is left for future work. If a dedicated enrichment plant must be reserved for use with recycled fuel, then cost penalties would appear to be inevitable.

### 4.3 Effect of Burnup on Fuel Cycle Cost

#### 4.3.1 Once-through Fuel Cycle

In the previous chapter the once-through fuel cycle was optimized with respect to fuel-to-moderator volume ratio. Here we will find the

optimum burnup to yield the minimum fuel cycle cost for this mode of operation. The reactor system analyzed is again the Maine Yankee reactor, introduced in the preceding chapter. The unit prices of the different steps in the nuclear fuel cycle were selected from References (A-1) and (D-2). In reference (A-1) the "high" and "low" bounds on the cost of each transaction have been given. These high and low prices will be used to estimate the one-sigma uncertainty in fuel cycle cost due to assigned uncertainty in the unit prices. Table (4.1) shows the base, low and high unit costs for each step. In the fourth column the standard deviation of each step has been given. These standard deviations have been calculated by subtracting the high and low costs and dividing the result by the factor 2.0. In effect, a normal distribution function was assumed for each variable and a 68% chance assumed that the unit price will fall between the high and low costs. (One may plausibly argue for greater certainty: if "high" and "low" encompass 95% of the likely values, then the values shown will be reduced by a factor of 2, as will be the  $\sigma$  value deduced for fuel cycle costs.)

Table (D-6) in Appendix D shows the mass flows charged and discharged, and Table (E-6) presents the quantity of each step in the nuclear fuel cycle for a 3 batch core. Using these mass quantities, the base unit prices given in Table (4-1) and other economic parameters (such as the discount rate) from Table (3-2) in SIMMOD one can find the overall levelized fuel cycle cost as a function of burnup, as shown in Figure (4-4). Note that it was assumed that the availability-based capacity factor is the same for all cases, having a value of 0.82. Thus, since the burnup is different for each case the refueling interval and the overall capacity factor are different for each case. Table (4-2) shows the burnup, the feed enrichment, refueling interval and capacity factor for each case for a 3 batch core. In the fifth column

TABLE 4.1

## UNIT COST OF DIFFERENT STEPS IN THE FUEL CYCLE (A-1)

<u>Transaction</u>	<u>Base Cost</u>	<u>Low, C<sub>L</sub></u>	<u>High, C<sub>M</sub></u>	<u>σ*</u>
U <sub>3</sub> O <sub>8</sub> Cost \$/lb	40	23.53	59.64	18.06
UF <sub>6</sub> Conversion \$/Kg HM	2.0	1.22	2.54	1.32
Fabrication \$/Kg HM	99.0	64.0	134.0	35.00
Enrichment (\$/Kg SWU)	94.0	64.0	123.0	29.50
Spent Fuel Transportation (\$/Kg HM)	17.0	6.0	22.0	8.0
Reprocessing (\$/Kg HM)	211.0	146.0	345.0	99.50
Waste Disposal \$/Kg HM	30.0	24.0	37.0	6.5
Disposal	110**	88	131	21.50

$$*\sigma = (C_M - C_L) / 2$$

\*\* From reference (D-2), disposal only

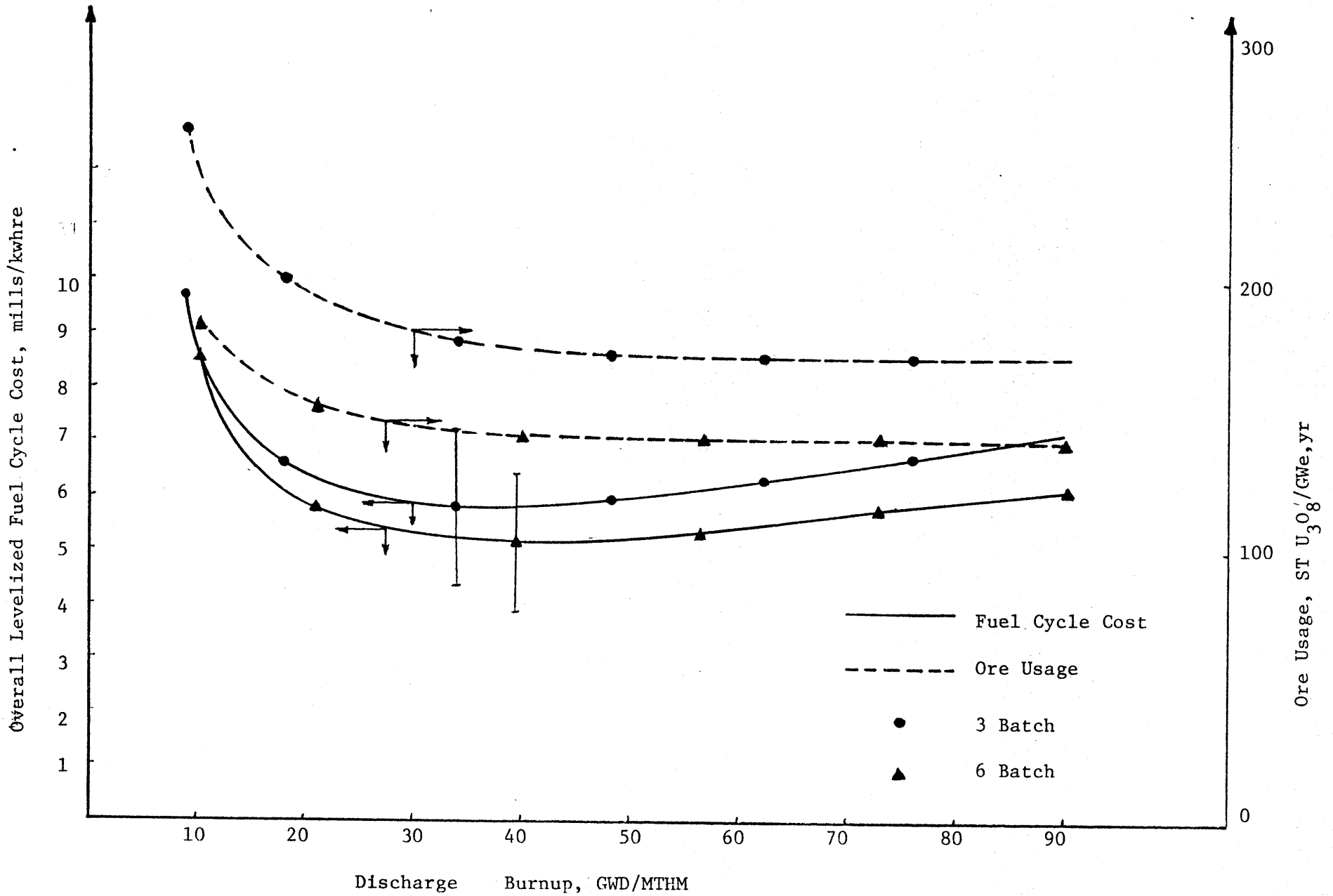

Figure 4.4 Overall Levelized Fuel Cycle Cost versus Burnup for Three and Six Batch Cores for Once-Through Operation

TABLE 4.2

## FUEL MANAGEMENT DATA FOR 3 BATCH CORE, ONCE-THROUGH MODE

<u>Enrichment (w/o)</u>	<u>Discharged Burnup GWD/MTHM</u>	<u>Capacity* Factor</u>	<u>Refueling* Interval yr</u>	<u><math>\bar{e}_o</math> mills/kwhre</u>	<u>Ore Usage ST/GWe-yr</u>
1.5	8.8	0.613	0.494	9.66	257.6
2.0	18.0	0.697	0.829	6.575	198.3
3.0	33.8	0.750	1.448	5.790	176.7
4.0	48.2	0.770	2.011	5.938	172.7
5.0	62.1	0.781	2.555	6.280	171.6
6.0	76.0	0.788	3.099	6.683	171.11

\*The availability-based capacity factor was assumed to be 0.82;

see Equation (2.27) for calculation of capacity factor

\*\*Including refueling downtime (0.125 year): time between successive startups



the overall levelized fuel cycle cost for the once-through scenario has also been given. As can be seen from Figure (4-4), the optimum burnup for the 3 batch core on the once-through cycle is about 33.8 GWD/MTHM, which is representative of current PWR designs. (The Maine Yankee reactor has a nominal 33.0 GWD/MTHM discharge burnup). In this figure the ore usage has also been shown. The ore usage curve has been found by the model given in Reference (G-1). The ore usage curve shows that as the burnup is increased the annual ore requirement decreases monotonically. However, as can be seen from this figure, beyond the optimum burnup (33.8 GWD/MTHM) the overall levelized fuel cycle cost increases as burnup is increased. Thus there is no motivation to go to higher burnup from the point of view of fuel cycle cost. Nevertheless, since the fuel cycle cost versus burnup curve is quite flat in the vicinity of the optimum burnup, the burnup in this case could be extended to 45 GWD/MTHM to take advantage of the reduction in ore consumption without serious economic penalties. Longer burnups are also found if system cost is minimized because of the high cost of makeup power when a reactor is shutdown.

It is also of interest to illustrate the effect of increasing the number of core batches. Therefore a 6 batch core was also considered. Tables (D-7) and (E-7) show the mass flows charged and discharged and the quantity of each transaction in the fuel cycle for the 6 batch core. Using these data and other economic information as before, one can find the overall levelized fuel cycle cost as a function of burnup, as shown in Figure (4-4). Table (4-3) also shows the overall levelized fuel cycle cost, ore requirement and other parameters for the six batch core on the once-through cycle. Ore usage has also been shown for the six batch core on Figure (4-4).

TABLE 4-3

FUEL MANAGEMENT DATA FOR A SIX BATCH CORE ON THE ONCE-THROUGH FUEL CYCLE

<u>Enrichment w/o</u>	<u>Discharged Burnup GWD/MTHM</u>	<u>Capacity* Factor</u>	<u>Refueling** Interval yr</u>	<u><math>\bar{e}_o</math> Mills/kwhre</u>	<u>Ore Usage ST/GWe.yr</u>
1.5	10.1	0.502	0.323	8.56	185.75
2.0	21.0	0.629	0.536	5.787	153.6
3.0	39.6	0.706	0.900	5.156	142.01
4.0	56.6	0.737	1.233	5.347	140.8
5.0	73.0	0.754	1.554	5.716	140.65
6.0	90.5	0.766	1.8962	6.104	139.7

\*The availability-based capacity factor was assumed to be 0.82.

See Equation (2.27) for calculation of capacity factor.

\*\*Including refueling down time (0.125 yr): time between successive startups.

As can be seen from Figure (4-4), the optimum burnup for the six batch core is 42 GWD/MTHM, and as with the three batch core, the fuel cycle cost around the optimum burnup is flat, so that the burnup can be increased to roughly 50 GWD/MTHM without a significant change in fuel cycle cost.

Comparison of the fuel cycle cost versus burnup curve for the three batch and six batch cores shows that;

- (a) for discharged burnup greater than 10 GWD/MTHM, the overall levelized fuel cycle cost for the six batch core is less than that for the three batch core.
- (b) The optimum discharged burnup of the six batch core (42 GWD/MTHM) is greater than that for the three batch core (33.8 GWD/MTHM). However, since the fuel cycle cost does not change significantly around the optimum discharged burnup, the discharged burnup of the three batch core can be increased to ~42 GWD/MTHM, without sacrificing much in the way of fuel cycle cost.
- (c) The minimum fuel cycle cost for the six batch core (5.10 mills/KWhre) is 12% less than the minimum fuel cycle cost of the three batch core (5.79 mills/kwhre).
- (d) The ore usage for the six batch core is always less than that for the three batch core.

The above analysis employed the base unit prices given in Table (4-1), however, as mentioned before, there is a certain degree of uncertainty in the unit cost of each step in the fuel cycle, characterized in Table 4-1 by  $\sigma$ , the standard deviation, from which we can find the resulting uncertainty in the fuel cycle cost.

In reference (G-5), it is shown that if  $Z$  is a function of  $n$  variables  $x_1, x_2, \dots, x_n$ , then the variance of  $Z$ ,  $\sigma_Z^2$ , can be written:

$$\sigma_Z^2 \approx \sum_{i=1}^N \left( \frac{\partial Z}{\partial x_i} \right)^2 \sigma_{x_i}^2 \quad (4.44)$$

Using Equation (4.44) and the simple economic model derived in Chapter 2, namely

$$\bar{e}_o = \frac{1}{1000E} \sum_{i=1}^I M_i C_i F_i G_i \quad (2.16)$$

and assuming the unit costs in each step of fuel cycle are independent, one can find the standard deviation of the overall levelized fuel cycle cost,  $\sigma_e$ , as

$$\sigma_{e_o} = \left[ \sum_{i=1}^I \left( \frac{\sigma_{C_i}}{\bar{C}_i} \right)^2 e_i^2 \right]^{1/2}, \text{ mills/kwhre} \quad (4.45)$$

where

$\sigma_{C_i}$  = standard deviation of each step in the fuel cycle (given in the fourth column of Table (4-1))

$\bar{C}_i$  = the average unit cost of each step in the fuel cycle (given in the second column of Table (4-1))

$\bar{e}_i = M C F G / 1000E$ , the partial cost of each step in the fuel cycle, mills/kwhre ( $\bar{e}_o = \sum_{i=1}^I \bar{e}_i$ )

Using the data given in Table (4-1) and the output of SIMMOD for the partial cost of each step in Equation (4-45) one can find  $\sigma_{e_o}$ , (i.e. a 68% probability exists that the levelized fuel cycle cost is in the range

$\bar{e}_o \pm \sigma_{e_o}$ ). Thus the standard deviations of the fuel cycle cost for the three batch core and the six batch core, for the discharged burnup around their respective optimum values, were found to be 1.5 and 1.34 mills/kwhre, respectively. In Figure (4-4) the bars indicate one standard deviation around the average. It should be noted that, since the partial costs vary with burnup the  $\sigma_{e_o}$  will also vary; however the variation is not very large, so that the  $\sigma_{e_o}$  values shown may be assumed to be typical for the remainder of the curve. As can be seen, the margin of uncertainty is rather large (even if the high and low estimates bracket 95% of all cost variations instead of 68%, the error flags would only be cut in half). This should be kept in mind in the comparisons made in this and other evaluations. Indeed a reduction in uncertainty would have more import than most technological improvements. Other caveats are also in order: the probability distribution functions for all (or even most) variables are probably not normal; if variables are correlated rather than independent the expression used to combine variances ( $\sigma^2$ ) will give an underestimate.

#### 4.3.2 Uranium Cycle with Uranium and Plutonium Recycle

The effect of burnup on the uranium cycle with recycling of plutonium and uranium is the subject of this section. The re-enrichment method discussed in Section 4.2.2 is employed here to calculate the credit for discharged uranium. The mass flows charged and discharged are given in Tables (D-6) and (D-7) for the three and six batch cores respectively. The equations given in Appendix E were employed to calculate the mass transactions for each step of the fuel cycle. The assumptions which have been used for determination of the mass transactions have also been discussed there. Using these data along with the unit prices given in

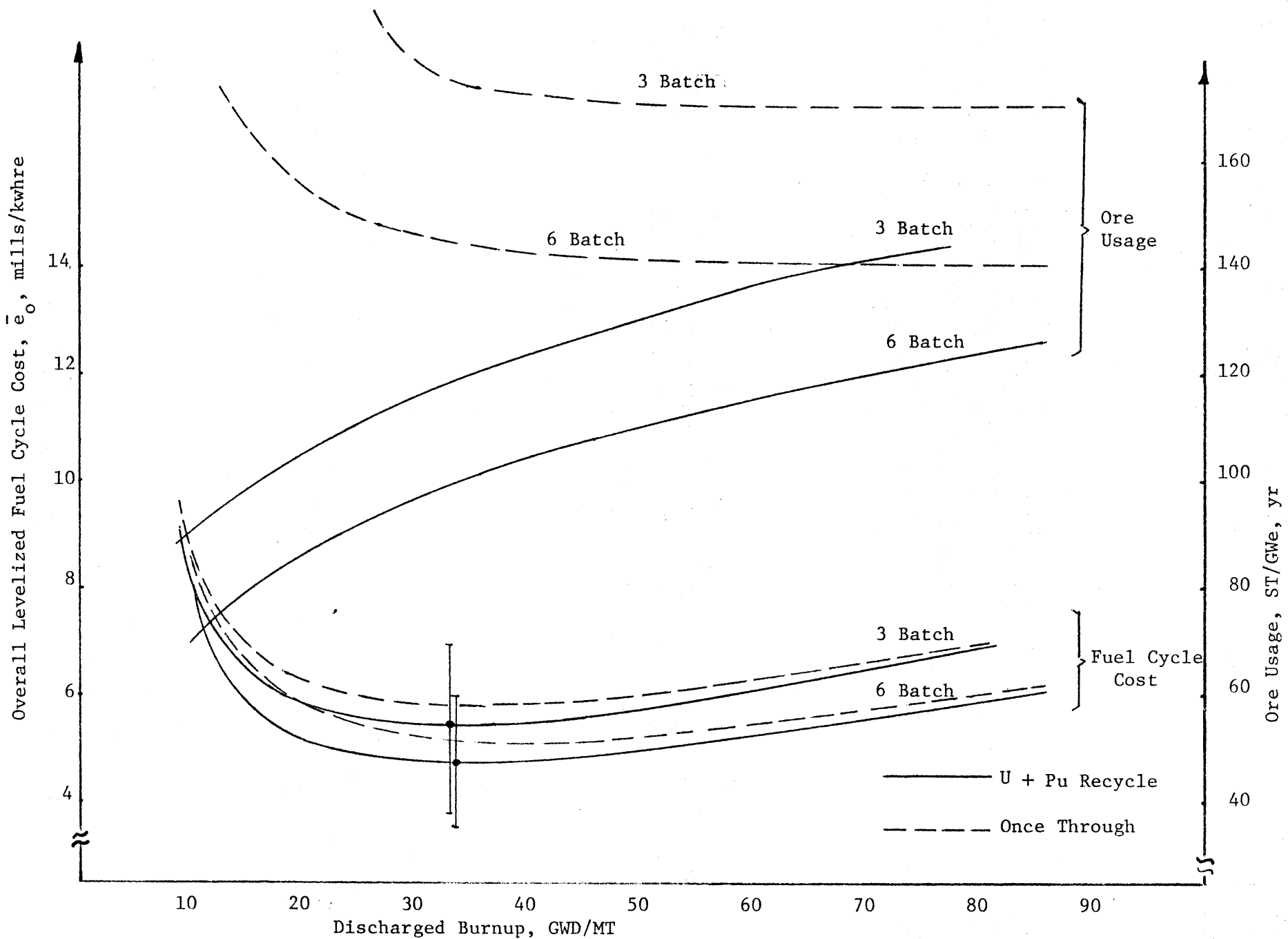

Figure 4.5 The Overall Levelized Fuel Cycle Cost and Ore Usage versus Burnup for the 3 and 6 Batch Cores

Table (4-1) the overall fuel cycle cost can be calculated using SIMMOD. Note that the unit price of fissile plutonium was obtained using Equation (3-37), which yielded 26,000 \$/Kg for fissile plutonium.

Figure 4.5 shows the overall levelized fuel cycle cost as a function of burnup for the three and six batch cores in the uranium and plutonium recycling mode. This figure was developed using the transaction quantities given in Tables (E-6) and (E-7). The overall levelized fuel cycle cost for the once-through fuel cycle mode has also been shown to facilitate comparison of the once-through and recycling modes. The ore usage as a function of burnup has also been shown in Figure (4-5) for the three and six batch cores in the recycling mode. The ore usage curve was obtained by using the data given in Tables (D-6) and (D-7) and the method discussed in reference (C-3). These figures show that for both the three and six batch cores the optimum burnup is about 35 GWD/MTHM. However the minimum fuel cycle cost for the six batch core (4.75 mills/kwhre) is 12% less than that for the three batch core (5.40), and in the vicinity of optimum discharged burnup, the fuel cycle cost curve for the six batch core is flatter than that of the three batch core so that the discharged burnup for the six batch core can be increased to about 42 GWD/MTHM without an appreciable change in fuel cycle cost.

Although the fuel cycle cost behavior encourages increasing the discharged burnup to its optimum value, the annual ore requirement discourages increasing the discharged burnup. Also, as can be seen, both the fuel cycle cost and the ore usage are greater for the 3 batch core. Comparative analysis of the once-through fuel cycle mode and the recycling mode reveals that the fuel cycle cost for the recycling mode is slightly smaller than for the once-through mode under comparable conditions (same number of batches,

optimum burnup). The difference decreases as discharged burnup is increased and in any event is not to be considered significant in view of the uncertainties involved. This behavior is expected, since as the discharged burnup is increased the residence time of each batch in the core is increased, the present worth factors for back end steps of fuel cycle become smaller, and thus the net cost or benefits of back end transactions become less significant. This figure shows that the optimum discharged burnup for the 3 batch core is almost the same for both modes of the fuel cycle; however for the six batch core the optimum discharged burnup is greater for the once-through mode than for the recycling mode (42 versus 35 GWD/MTHM). The overall fuel cycle cost and annual ore usage are about 7% and 27% greater, respectively for the once-through fuel cycle than for the case with uranium and plutonium recycling for the six batch core and optimum discharged burnup. Also, as can be seen from this figure the fuel cycle cost for the once-through fuel cycle mode and the six batch core is smaller than for the recycling mode of the 3 batch core for discharged burnups greater than 21 GWD/MTHM; for optimum discharged burnup the fuel cycle cost is 5.5% lower for the once-through mode, nevertheless the annual ore requirement is 7% higher for the once through mode.

The above discussion reveals that the six batch core and the recycling mode is the most attractive scenario by a narrow margin. Note that in the above analysis the refueling downtime (the time between two successive start ups) was assumed to be 0.125 years (6.5 weeks) for the six batch core. Reducing the refueling down time increases the capacity factor and hence decreases the overall levelized fuel cycle cost. Andrews (A-4) has reported a quick refueling scheme which reduces the refueling down time



from six weeks to three weeks. Although, as mentioned in Reference (F-3), "a significant number of utilities have not purchased this fuel management scheme," the attraction of the six batch core from both the point of view of fuel cycle cost and ore usage, may ultimately prevail. Thus the impact of 3 weeks refueling down time (0.058 years) on the overall levelized fuel cycle cost of the 6 batch core is examined in Section 4.5.1.

To determine the variance of fuel cycle cost again we use Equation (4.45) along with the data given in Table (4-1). However the variance of fissile plutonium price must also be determined. To obtain this variance it should be noted that the price of fissile plutonium is dependent on other unit prices such as those for ore, fabrication, reprocessing, etc. The unit price of plutonium, on the basis of the indifference concept, can be written

$$C_{Pu} = \sum_{i=1}^I \alpha_i C_i \left| \begin{array}{l} - \sum_{i=1}^I \alpha_i C_i \\ \text{producer} \quad \text{consumer} \end{array} \right| \quad (4.46)$$

where the  $\alpha_i$  are constants and the  $C_i$  are unit prices for each step of the fuel cycle (except for credit or purchase of Pu) and the summation is over all steps in the nuclear fuel cycle (see Section (3.6) for a more detail explanation). Use of Equation (4.46) with Equation (4.44) results in

$$\sigma_{C_{Pu}}^2 = \sum_{i=1}^I \alpha_i^2 \sigma_{C_i}^2 \left| \begin{array}{l} - \sum_{i=1}^I \alpha_i^2 C_i^2 \\ \text{producer} \quad \text{consumer} \end{array} \right| \quad (4.47)$$

Employing the Simple Model,  $\alpha_i$  can be determined as

$$\alpha_i = \frac{e_i/C_i}{(e_{Pu}^C + e_{Pu}^P)/C_{Pu}} = \left( \frac{C_{Pu}}{C_i} \right) \left( \frac{e_i}{e_{Pu}^C + e_{Pu}^P} \right) \quad (4.48)$$

where  $e_i$  and  $C_i$  have been defined before,  $e_{Pu}^C$  and  $e_{Pu}^P$  are partial costs of the fuel cycle due to net purchase of fissile plutonium for consumer reactors and credit due to discharged fissile plutonium from the producer reactor, respectively. Using the output of SIMMOD for the Maine Yankee Core, where both producer and consumer reactors have their optimum  $V_f/V_m$  (0.4816),  $e_i$ ,  $e_{Pu}^C$ ,  $e_{Pu}^P$  and then  $\alpha_i$  can be found. Employing Equation (4.47) gives the  $C_{Pu}$ , which is 11.7 \$/gr, where the base cost is 26 \$/gr. Using this value of  $\sigma$  for fissile plutonium in Equation (4.45),  $\sigma_{e_o}$  for the recycling mode can be found, namely 1.53 and 1.27 mills/kwhre, for the three batch and six batch cores, respectively; these are shown as error flags in Figure (4-5).

#### 4.3.3 Analysis of Approximations

To calculate the fuel cycle cost, the Simple Model was employed. As described in Chapter 2 this model deals only with steady state batches, and the effects of startup batches and shutdown batches were ignored. It was shown that for a three batch core the total error is not greater than 3% for all assumption. However for a six batch core, where there are 5 startup batches, the error should be determined. Thus, Equation (2.39) will be employed to consider the effect of startup batches. Using this equation gives 4.63 mills/kwhr and 5.7 mills/kw for the recycling and once-through modes, respectively for optimum discharged burnup, whereas if the startup batches are ignored the fuel cycle costs are 4.31 and 5.15 mills/kw for the recycling and once-through modes, respectively. Hence

current results are optimistic.

Thus development of a systematic, and hopefully simple, means for including startup batches in SIMMOD is recommended.

#### 4.4 Effect of Ore Escalation Rate on Optimum Discharged Burnup

In this section the effect of ore scarcity-related escalation rate on the optimum discharged burnup of the three and six batch cores is studied

In section 3.5 three cases for variation of ore price were considered, where two cases could be considered to be equivalent, and where all three gave comparable results. Thus, here only one scenario will be examined: the time-zero cost of ore is assumed to be 40 \$/lb and the scarcity-related ore escalation rate is varied. Figure (4-6) shows the effect of the scarcity related escalation rate on the fuel cycle cost as discharged burnup is increased for three and six batch cores and for the once-through fuel cycle. As can be seen the optimum discharged burnup does not change. The fuel cycle cost for the six batch core is always smaller than that for the three batch core and the differences between the minimum fuel cycle cost of the three and six batch cores increases slightly as the ore escalation rate is increased, which favors the six batch core.

For the recycling mode of fuel cycle operation Equation (3.27) can be used to determine the value of plutonium as the ore escalation rate increases. Figure (4-7) shows the fuel cycle cost versus discharged burnup for 0 and 6%/yr escalation rate (where the price of fissile plutonium is 26.0 and 69.0 \$/gr respectively). This figure shows that the optimum discharged burnup will decrease as the scarcity related ore escalation rate is increased, and the minimum fuel cycle cost of the three batch core is always greater than that for the six batch core. The decrease of

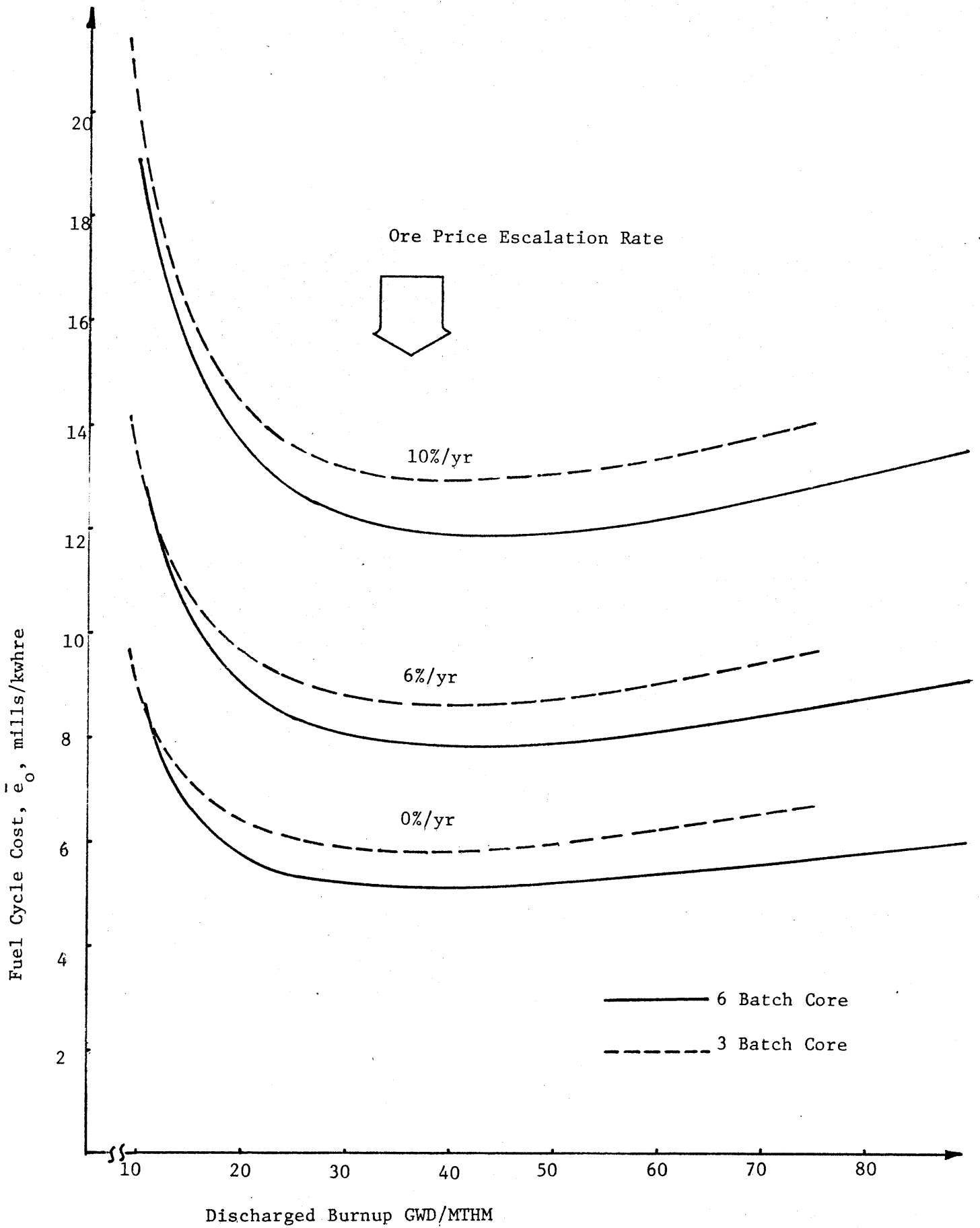

Figure 4.6 Fuel Cycle Cost versus Burnup for the Three and Six Batch Cores and the Once-through Fuel Cycle

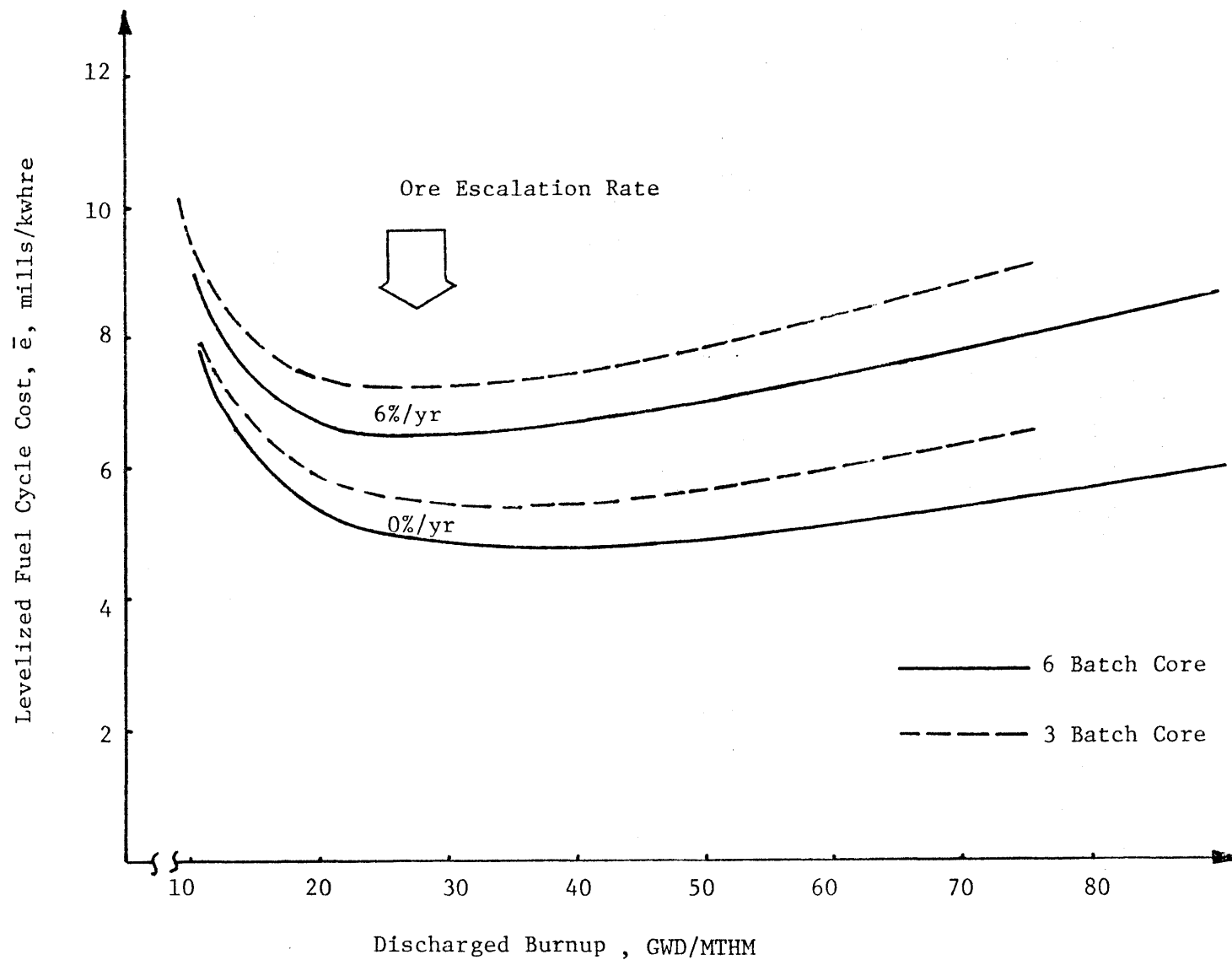

Figure 4.7 Fuel Cycle Cost versus Burnup for the Three and Six Batch Cores in the Recycling Mode

optimum burnup occurs because ore usage increases with discharged burnup; thus escalating the ore price discourages higher burnup. Comparing the once-through mode and the recycling mode shows that the fuel cycle cost of the recycling mode is less sensitive to variation of the escalation rate, and in this sense is more attractive.

A final note in regard to these comparisons. They are for a fixed time horizon (30 years), thus the number of fuel batches differ: more batches are required when burnup is reduced, fewer when burnup is high. Thus the parameter N varies in the Gi factor in the Simple Model.

#### 4.5 Effect of Other Options on the Optimum Discharged Burnup

##### 4.5.1 Short Refueling Downtime

In Section 4.3.2 it was mentioned that decreasing the refueling downtime increases the capacity factor, and hence the six batch core becomes a better option. Here we decrease the refueling downtime from 0.125 years to 0.058 years and study the impact of this reduction on the optimum discharged burnup of the six batch core. Figure (4-8) shows the fuel cycle cost versus burnup for the 0.125 and 0.058 yr. refueling downtimes. As can be seen, reducing the refueling downtime does not effect the optimum discharged burnup, however its effect on the fuel cycle cost is significant - the cost decreases about 8.5% as the refueling downtime decreases from 0.125 to 0.058 years (4.35 mills/kwhre for a 0.058 yr refueling downtime versus 4.75 mills/kwhre for a 0.125 yr refueling downtime, both for the recycling mode). For the once-through mode this reduction in refueling downtime causes the minimum fuel cycle cost to decrease ~6.8% (4.80 mills/kwhre for a 0.058 yr refueling downtime versus 5.15 mills/kwhre for the 0.125 yr refueling downtime). Thus, there is a non-negligible incentive to consider

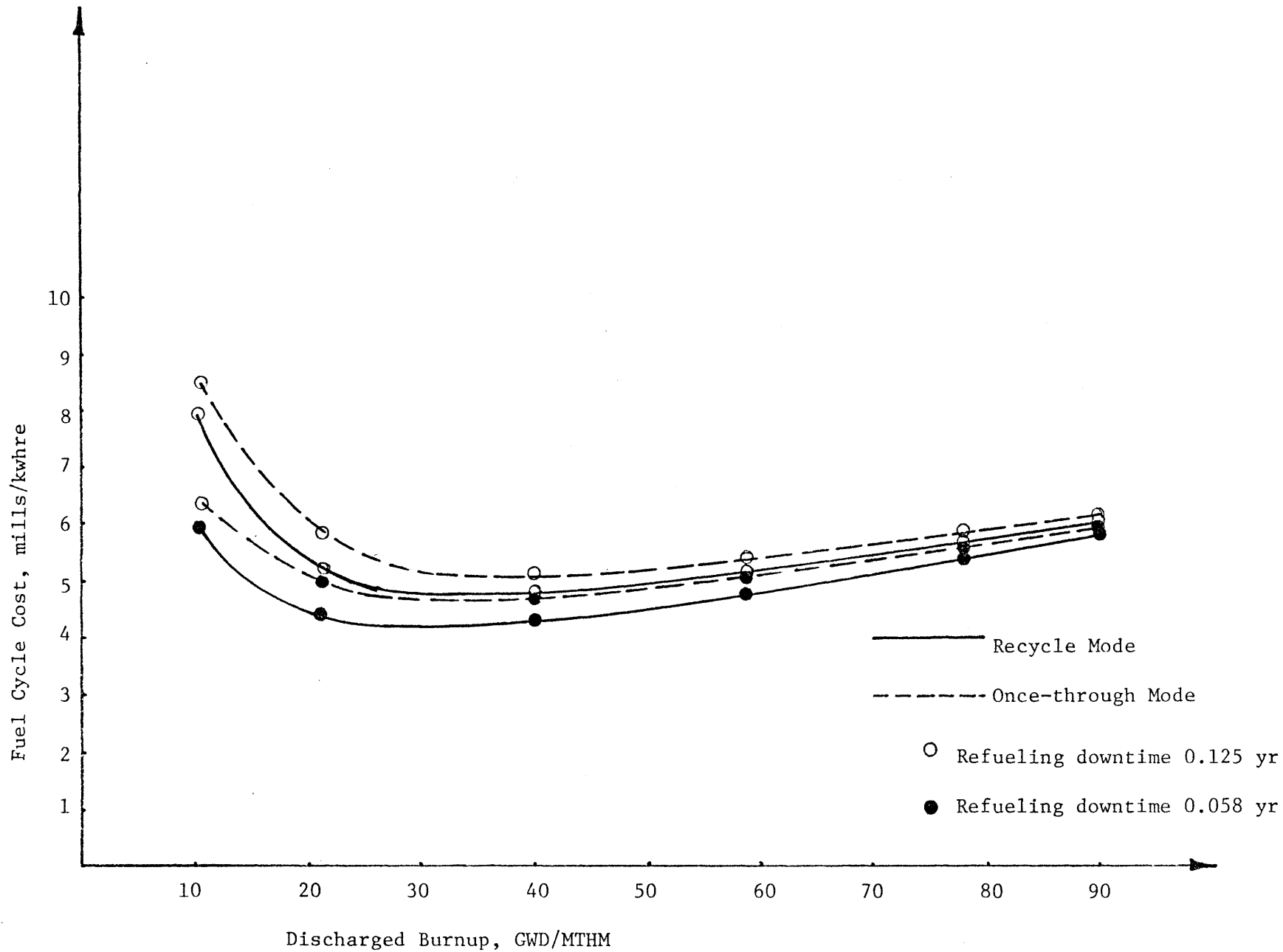

Figure 4.8 Fuel Cycle Cost versus Burnup for 3 and 6.5 week Refueling Downtime

the pursuit of a 3-week refueling downtime.

#### 4.5.2 Effect of Discharged Burnup on the Busbar Cost

The Busbar cost of electricity can be written as (D-4)

$$e_b = \frac{1000}{8766L} \left[ \Phi \left( \frac{I}{K} \right) + \left( \frac{O}{K} \right) \right] + e_f \quad (4.49)$$

where

$e_b$  = Busbar cost of electricity, mills/kwhre

$L$  = capacity factor

$\Phi$  = annual fixed charged rate,  $\text{yr}^{-1}$

$\left( \frac{I}{K} \right)$  = capital cost of the unit, \$/kwe

$\frac{O}{K}$  = Annual operating cost, \$/kweyr

$\eta$  = plant thermal efficiency (MWe/MWT)

$e_f$  = fuel cycle cost, mills/kwhre

In Equation (4.49) the capital cost and operating cost are fixed for a unit and do not change with different fuel management schemes. Thus we can write

$$e_b = \frac{A}{L} + e_f \quad (4.50)$$

where A is equal to

$$A = \frac{1000}{8766} \left[ \Phi \left( \frac{I}{K} \right) + \left( \frac{O}{K} \right) \right] \quad (4.51)$$



and is constant for an installed plant.

Now assume for the reference case a capacity factor equal to  $L_o$  and a busbar cost,  $e_{ob}$  which is  $\xi$  times the fuel cycle cost,  $e_{of}$ , thus,

$$e_{ob} = \xi e_{of} \quad (4.52)$$

If we use Equation (4.52) in Equation (4.50), there results;

$$A = L_o (\xi - 1) e_{of} \quad (4.53)$$

Substituting Equation (4.53) into Equation (4.50) gives

$$e_b = e_f + \left(\frac{L_o}{L}\right) (\xi - 1) e_{of} \quad (4.54)$$

Figure (4.9) shows the busbar cost versus discharged burnup (where the reference case was assumed to be a 3-batch core, with a 0.75 capacity factor ( $L_o$ ) on the once-through fuel cycle with discharged burnup of 33.8 GWD/MTHM, which results in a fuel cycle cost of 5.79 mills/kwhre for  $e_{of}$ ; in addition  $\xi$  was assumed to be 4.) As can be seen from this figure, the optimum discharged burnup increases for both 3 batch and six batch cores when the busbar cost is considered as the criterion. The optimum discharged burnup is 50 GWD/MTHM whereas for the six batch core it is 75 GWD. The minimum busbar cost is 22.8 mills/kwhre for the three batch core, whereas it is 23.0 mills/kwhre for the six batch core: a negligible margin in present terms.

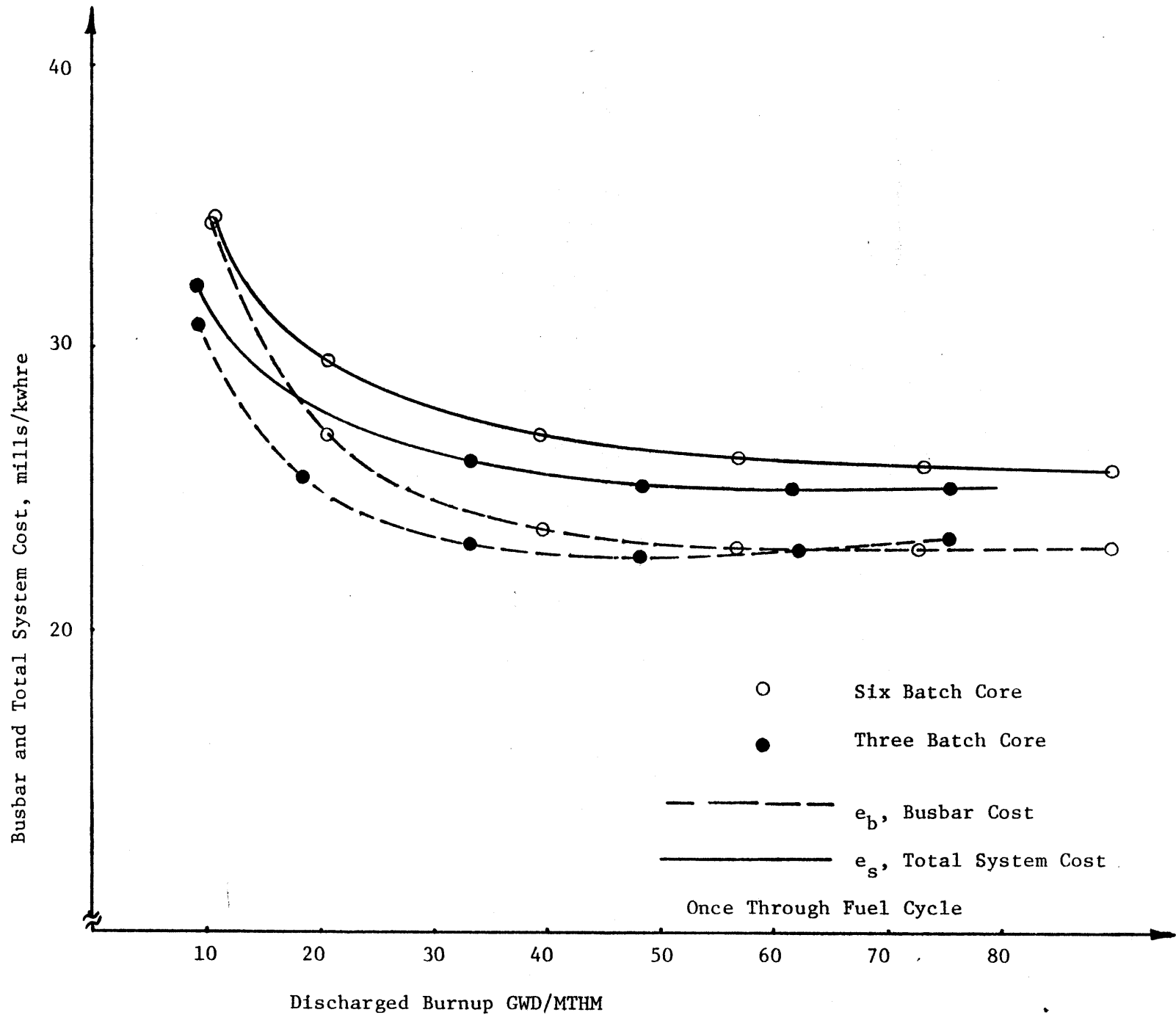

Figure 4.9 Busbar Cost and Total System Cost as a Function of Discharged Burnup for the Three and Six Batch Cores

The busbar cost in the vicinity of the optimum discharged burnup is so flat that the discharged burnup of the three and six batch cores can be increased to 60 GWD/MTHM and 95 GWD/MTHM without sacrificing significantly in terms of the busbar cost.

The increase of the optimum discharged burnup when the busbar cost is increased can readily be explained. According to Tables (4-2) and (4-3) the capacity factor increases for burnups greater than the optimum burnup (where the fuel cycle cost is minimum). Since the busbar cost is inversely proportional to the capacity factor, increasing the discharged burnup decreases the busbar cost. However for very high burnup the fuel cycle cost is high enough to increase the busbar cost as discharged burnup is increased.

#### 4.5.3 Consideration of Replacement Cost

During outages and refueling down time, where the reactor is not available for producing electricity, the short-fall in electric energy has to be provided (e.g. purchased) to satisfy the demand of the consumers. Thus the total cost is not merely the busbar cost: the effect of replacement energy cost must also be considered.

If we assume the total energy which could be produced by the reactor is  $E_T$  and the energy which has been produced by the reactor is  $E_b$  during one refueling interval, an amount  $E_R$  of electrical energy has to be bought where

$$E_R = E_T - E_b \quad (4.55)$$

Thus if we define  $e_b$  and  $e_R$  as the busbar cost and replacement cost of electricity respectively, the total cost,  $e_s$ , can be found as

$$e_s = \frac{E_b e_b + e_R E_R}{E_b + E_R} \quad (4.56)$$

According to the definition of capacity factor one can write

$$E_b = L \cdot E_T \quad (4.57)$$

$$E_R = (1 - L)E_T \quad (4.58)$$

Using Equations (4.57) and (4.58) in Equation (4.56):

$$e_s = L e_b + (1 - L) e_R \quad (4.59)$$

If we assume

$$e_R = \mu e_{ob} \quad (4.60)$$

Equation (4.59) can be written as

$$e_s = L e_b + \mu e_{ob} (1-L) \quad (4.61)$$

Substituting  $e_b$  from Equation (4.54) into Equation (4.61) gives

$$e_s = \mu e_{ob} (1-L) + L \left[ e_f + \frac{L_o}{L} (\xi-1) e_{of} \right] \quad (4.62)$$

Using the same conditions as before, and assuming  $\mu$  is equal to 1.5, Equation (4.62) along with the data given in Table (4-2) and (4-3) give the total system cost as shown on Figure (4.9).

As can be seen, the optimum discharged burnup increases if we consider total cost. For the total cost the optimum discharged burnup and minimum total cost are  $\sim 57$  GWD/MTHM and 25.4 mills/kwhre for the three batch core and  $\sim 90$  GWD/MTHM and 25.8 mills/kwhre for the six batch core, respectively. However again the curves are very flat in the vicinity of the optimum discharged burnup so that the three batch core burnup can be increased to 65 GWD/MTHM, and for the six batch core much greater than 90 GWD/MTHM. Note that the difference between the minimum total cost of the three batch and six batch cores is again negligible.

#### 4.6 Effect of Different Ways of Treating Nuclear Fuel Transactions

##### 4.6.1 Expensed Fuel Costs

In the previous sections the effects of increasing discharged burnup were studied when the nuclear fuel was considered as a capital investment and depreciated. However, as mentioned in section 2.2.2, the fuel cost could be considered as an operation and maintenance cost analogous to fossil fuel purchases.

To study this option Equation (2.32) was used to calculate the fuel cycle cost. Using this equation for the three batch core on the once-through fuel cycle, the fuel cycle cost as a function of burnup can be obtained as shown in Figure (4-10). For comparison the depreciated case is also shown. As can be seen, expensing the nuclear fuel cause the fuel cycle cost to decrease with respect to the depreciated treatment. The optimum discharged burnup increases from  $\sim 33$  GWD/MTHM when the nuclear fuel is considered as a depreciable investment, to  $\sim 50$  GWD/MTHM when it

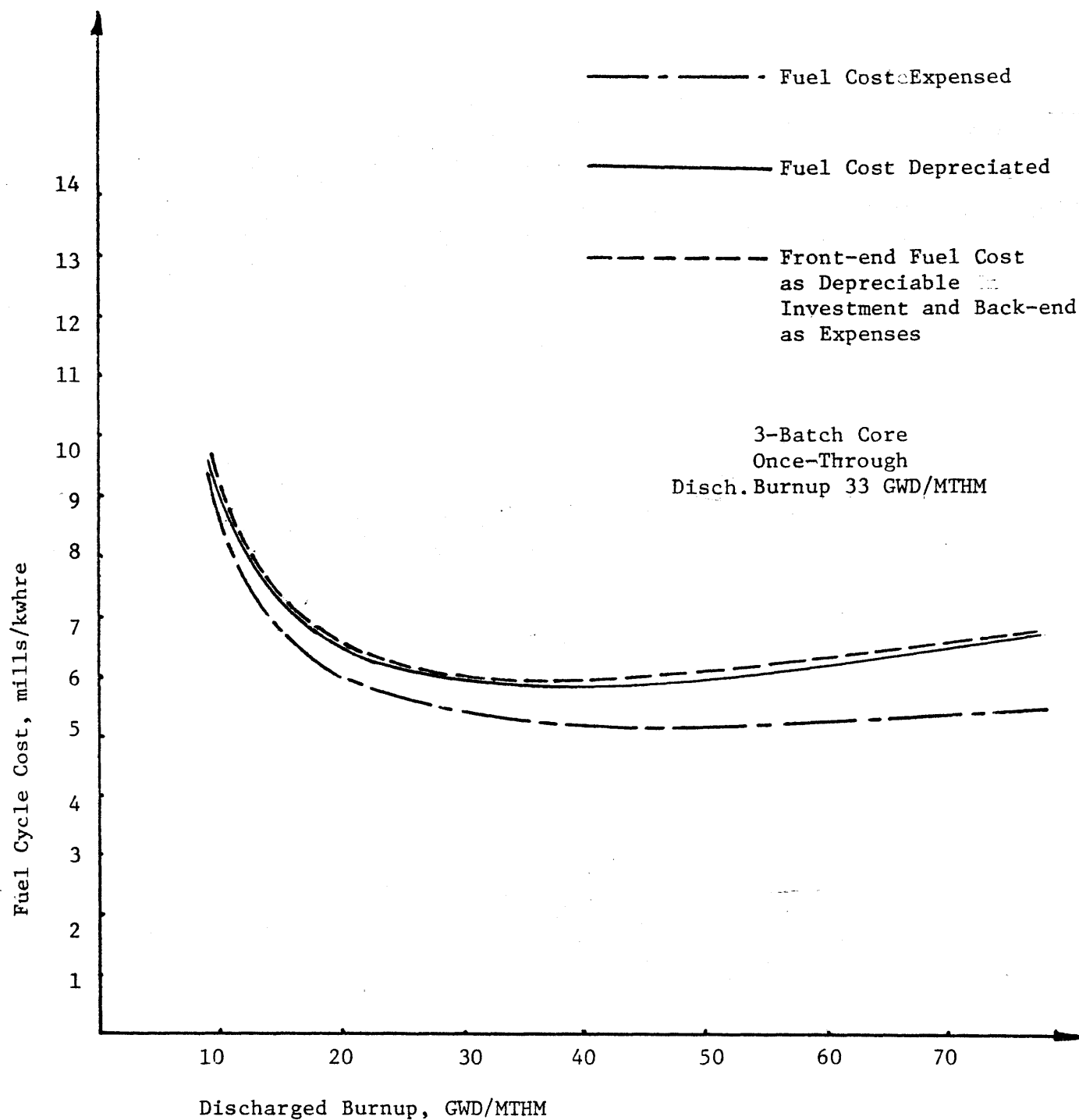

Figure 4.10 Fuel Cycle Cost versus Burnup, for Different Treatments of Nuclear Fuel

is considered as an expense. Thus it can be concluded that consideration of nuclear fuel as an expense would be a favorable change in convention.

#### 4.6.2 Front-end Depreciated and the Back-end Cost Expended

A hybrid treatment is also of considerable interest: the front end cost can be depreciated and the back end costs expended. In the annual financial reports of some utilities this policy has been reportedly used (S-5). Thus the impact of this treatment on the fuel cycle cost has also been studied here.

For this case, for front-end transactions Equation (2-16) must be used (where the fuel costs are considered as depreciable investments) and for back-end transactions Equation (2.32) must be employed as in the preceding section. Using these equations for the three batch core on the once-through fuel cycle, the fuel cycle cost versus burnup can be obtained as shown on Figure (4-10). As can be seen, treating the nuclear fuel in this way causes the fuel cycle cost to be slightly greater than when it is considered as purely depreciable investment, and thus the fuel cycle cost has the highest value with respect to the other options. The optimum burnup stays about the same as the wholly depreciated case.

### 4.7 Economic Analysis of Cladding Effects

#### 4.7.1 Breakeven Cost of Low-Absorption Clad

The ore requirement can be reduced by decreasing the parasitic absorption in the core. Using a clad material with low absorption cross section is one important way to save neutrons and thus improve ore usage. For this purpose the use of a Laser Isotope Separation (LIS) process to

separate out the more highly absorbing isotopes in zircaloy cladding is under investigation. Fujita (F-3) has shown that a 100% reduction in  $\sigma_a$  (the absorption cross section), results in a 5% reduction in ore requirement for the once-through mode of the fuel cycle. In this section we will find the breakeven cost of low absorption zircaloy clad.

For this purpose we assume that using zircaloy clad with low absorption cross section causes the overall levelized fuel cycle cost to decrease by  $\Delta e$ , mills/kwhre; thus to have the same fuel cycle cost as the case where no isotope has been separated, the fabrication cost can be increased by  $\Delta C_F$  (\$/KgHM). Therefore if  $M_H$  is the Kg of heavy metal charged to the reactor and  $M_{Zr}$  is the total amount of zircaloy used for cladding, the increased value of low absorption zircaloy can be found as,

$$\Delta C_{Zr} = \frac{M_H}{M_{Zr}} \cdot \Delta C_F \quad (4.63)$$

or the breakeven cost of zircaloy can be written;

$$C_{Zr} = C_{oZr} + \Delta C_{Zr} \quad (4.64)$$

where  $C_{oZr}$  is the price of zircaloy in \$/Kg when no isotopes are separated.  $C_{oZr}$  is approximately 9.5 \$/lb for billet bar and 14.5 \$/lb for sheet strip zirconium in 1976 dollars (M-2).

Now we define  $F$ , as the fractional reduction in clad absorption. It has been mentioned that if  $F$  is equal to 1.0 (100% reduction in  $\sigma_a$ ) there is a 5% decrease in ore usage. Here we assume that the percent reduction in ore requirement is directly proportional to  $F$ . Thus one can write



$$\frac{\Delta M_{U_3O_8}}{M_{U_3O_8}} = 0.05 F \quad (4.65)$$

where  $M_{U_3O_8}$  is the savings due to use of low absorption clad, and  $M_{U_3O_8}$  is the amount of ore needed for the standard case (no isotope separation).

Since,

$$M_{U_3O_8} = (\text{heavy metal charged}) \left( \frac{\omega - 0.002}{0.00511} \right) \quad (4.65)$$

Equation (4.65) can be written as

$$\frac{\omega_L - 0.002}{\omega_o - 0.002} = 1 - 0.05 F \quad (4.66)$$

where  $\omega_L$  is the weight fraction of  $^{235}\text{U}$  in fuel charged to a reactor using low absorption clad, and  $\omega_o$  is the weight fraction of  $^{235}\text{U}$  in the fuel charged where the standard clad is used.

The characteristics of the Maine Yankee core are used again to analyze the economics of low absorption clad. Employing the core characteristics of this reactor one finds that the ratio of the total Kg HM charged to the total amount of zircaloy used for cladding is 4.3 ( $M_H/M_{Zr} = 4.3$ ). For this case we consider a three batch core and feed enrichment equal to 3.0 w/o. Employing Equation (4.66) one can find the feed enrichment for each value of F. Using the Equations given in Appendix E for determination of transaction quantities and other economic parameters as before,  $\Delta e$ , the decrease in fuel cycle cost as the result of using zircaloy with low  $\sigma_a$  can be found. Table (4-4) shows  $\Delta e$  and  $\Delta C_F$  (the increased cost of fabrication which gives the same fuel cycle cost).

TABLE 4.4\*

## THE BREAKEVEN INCREASED COST OF LOW-ABSORPTION ZIRCALOY

<u>F</u>	<u><math>\Delta e^{**}</math></u> (mills/kwhre)	<u><math>\Delta C_F</math></u> (\$/Kg <sup>F</sup> HM)	<u><math>\Delta C_{Zr}^{***}</math></u> (\$/Kg <sup>Zr</sup> Zr)
0.25	0.070 (1.23%)	1.238	5.323
0.5	0.143 (2.50%)	2.531	10.883
0.75	0.214 (3.75%)	3.854	16.572
1.0	0.2868 (5.0%)	5.403	23.233

\*for F = 0, the fuel cycle cost and fabrication cost are 5.725 mills/kwhre and 99 \$/Kg HM respectively

\*\*the numbers in parentheses are percent reduction with respect to the case when no isotope separation is done

\*\*\*for comparison the price of sheet strip zirconium is ~32 \$/Kg in 1976 \$ (M-1)

Thus Equation (4.63) gives us  $C_{Zr}$ , the maximum allowable increase in the price of zircaloy due to removal of isotopes with high absorption cross section. If the LIS method increases the price of zircaloy more than that given in Table (4-4) it is not worth using this process. Therefore for 100% removal of high absorption isotopes the price of zircaloy should not be increased more than 23 \$/Kg HM: for 50% removal, which is a more reasonable goal, less than 11 \$/Kg is allowable to cover the cost of separation, thus the price of sheet strip zirconium can be increased from 32 \$/Kg to 43 \$/Kg, or by about 33%. We are not in a position to judge what isotope separation would cost, but it is probably greater than 33% of the current cost of zirconium: indeed if 1/2 the zirconium is separated out, and cannot be resold for non-nuclear uses, the cost would be doubled even if isotope separation were free.

#### 4.7.2 Effect of $V_f/V_m$ on the Comparative Analysis of Zircaloy and Stainless Steel

Although the advantages of zircaloy clad over stainless steel from the point of view of their effect on the economics of nuclear power reactors have long since been proven (B-2), (B-3), (B-4), Correa (C-2) has shown that as the fuel-to-moderator volume ratio is increased the ratio between the absorption of neutrons in stainless steel and zircaloy decreases. Figure (4-11) shows the ratio of (core-spectrum averaged) macroscopic and microscopic absorption cross sections of stainless steel and zircaloy clad as a function of fuel-to-moderator volume ratio (C-2). As can be seen, for tight-lattice pitches the microscopic cross section of stainless steel becomes less than that of zircaloy and the macroscopic cross section ratio decreases in proportion. This behavior, along with the better

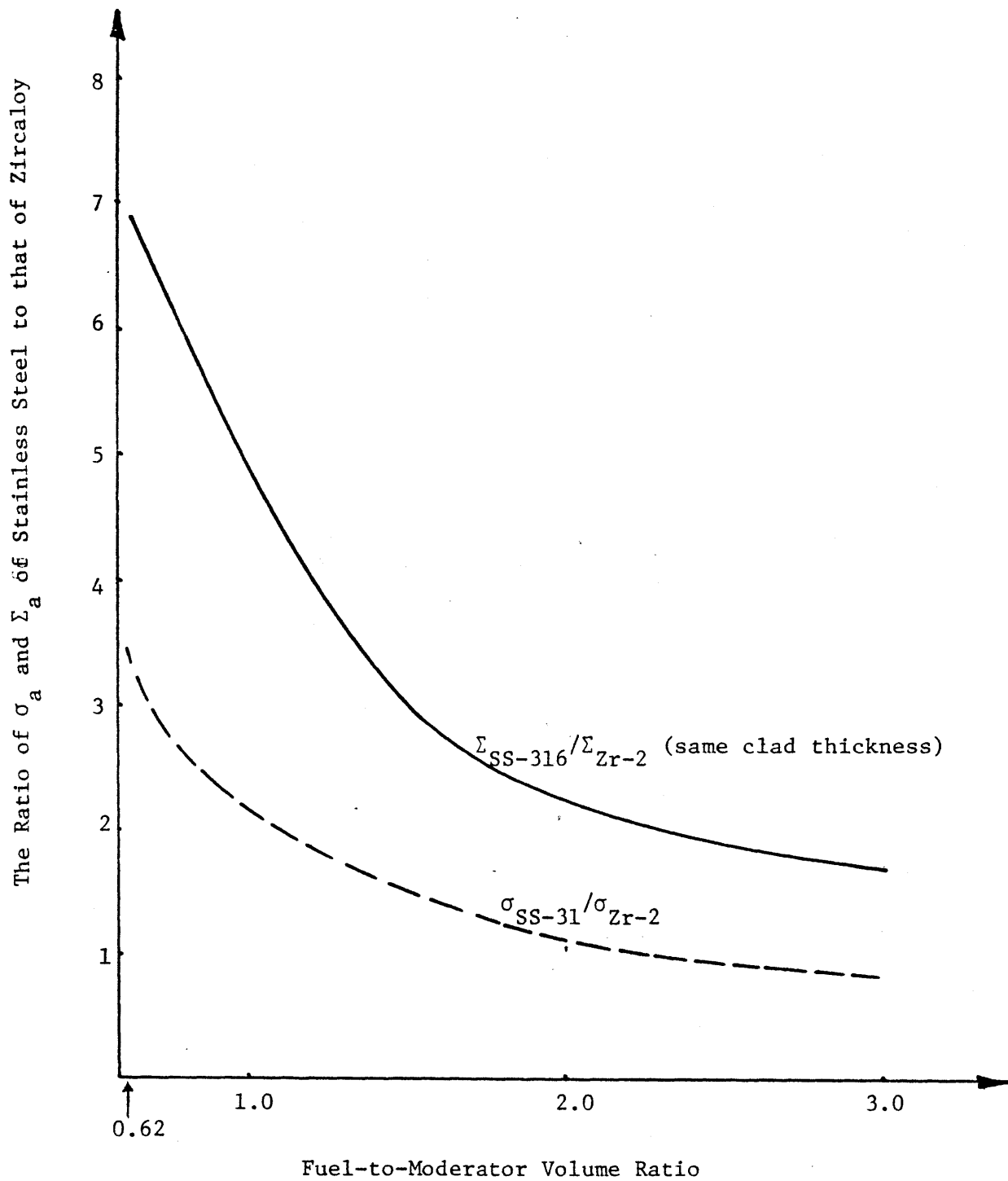

Figure 4.11 Ratio between the Absorption of Neutrons in Stainless Steel and Zircaloy as a Function of  $V_f/V_m$  (C-2)

mechanical performance of stainless steel, which results in a smaller clad thickness for the same operational conditions, suggests that the advantages of zircaloy over stainless steel be re-evaluated for tight pitch cores.

As mentioned in Chapter 3, increasing the fuel-to-moderator volume ratio is only worth considering for a consumer reactor. Thus here we consider  $^{233}\text{U}/^{232}\text{Th}$  units (since the potential for increasing  $V_f/V_m$  appears to be better than for  $^{239}\text{Pu}/^{238}\text{U}$ ) and study the effect of zircaloy and stainless steel clad on the fuel cycle cost. Table (D-8) in Appendix D shows the mass flows charged and discharged. Transaction quantities are given in Table (E-8). The thickness of the clad was assumed to be 26 mils for zircaloy clad and for stainless steel this thickness was assumed to be 18 mils. Using the unit costs given in Table (3-2) the fuel cycle cost can be obtained as a function of  $V_f/V_m$ . Note that the unit price of fissile material was assumed to be constant at 34,000 \$/Kg (see Equation (3.28)). In Reference (B-3) the fabrication cost of stainless steel and zircaloy for the uranium cycle have been given as 100 and 140 \$/Kg HM, respectively. Since the difference between the fabrication costs of zircaloy and stainless steel is related to the hardware cost (tubing, end cap, springs, retainer, etc. (L-2)) and material costs, which are independent of the mode of fuel cycle employed, we assume the 40 \$/Kg HM difference in the fabrication cost of stainless and zircaloy is also applicable for the  $^{233}\text{U}/^{232}\text{Th}$  cycle. Thus from Table (3-2) the fabrication cost of zircaloy clad fuel and stainless steel clad fuel are 570 \$/Kg HM and 530 \$/Kg HM, respectively. Figure(4-12) shows the overall levelized fuel cycle cost as a function of  $V_f/V_m$  for the two different types of cladding. These curves are for 3 batch cores, a discharged burnup equal to 33 GWD/MTHM and the characteristics of the

Maine Yankee Core.

As can be seen from this figure, at low fuel-to-moderator volume ratio (current PWR designs) the fuel cycle cost for zircaloy cladding is about 8% smaller than for stainless steel cladding, however, for high  $V_f/V_m$ , namely 2.5, the difference is reduced to only 0.7% and for  $V_f/V_m$  greater than about 2.6 the fuel cycle cost for stainless steel cladding is smaller than with zircaloy cladding. Thus for tight lattice pitches stainless steel cladding has advantages over zircaloy. It should be noted that if we assume the fabrication cost of zircaloy and stainless steel cladding are equal at 570 \$/Kg, at  $V_f/V_m$  equal to 2.5, the fuel cycle cost for stainless steel cladding is about 2.4% greater than that for the zircaloy cladding, which is a quite small price to pay to get the advantages of the better mechanical performance of stainless steel, especially for high discharged burnup. It may also be that stainless steel clad has advantages in burnout and LOCA - damage resistance, which would help make tight pitch cores practicable.

#### 4.7.3 Effect of Discharged Burnup on the Comparative Analysis of Zircaloy and Stainless Steel Clad

The effect of discharged burnup on the economics of PWRs using zircaloy or stainless steel clad has also been studied before (B-3). In the previous chapter it was shown that the optimum discharged burnup for the total system cost for the six batch core is ~90 GWD, and it is almost as great for the three batch core. There is considerable uncertainty regarding the behavior of zircaloy at these high exposures, and stainless steel clad is expected to be more durable. Thus it is of interest to study the impact of using stainless steel on the fuel cycle cost when the

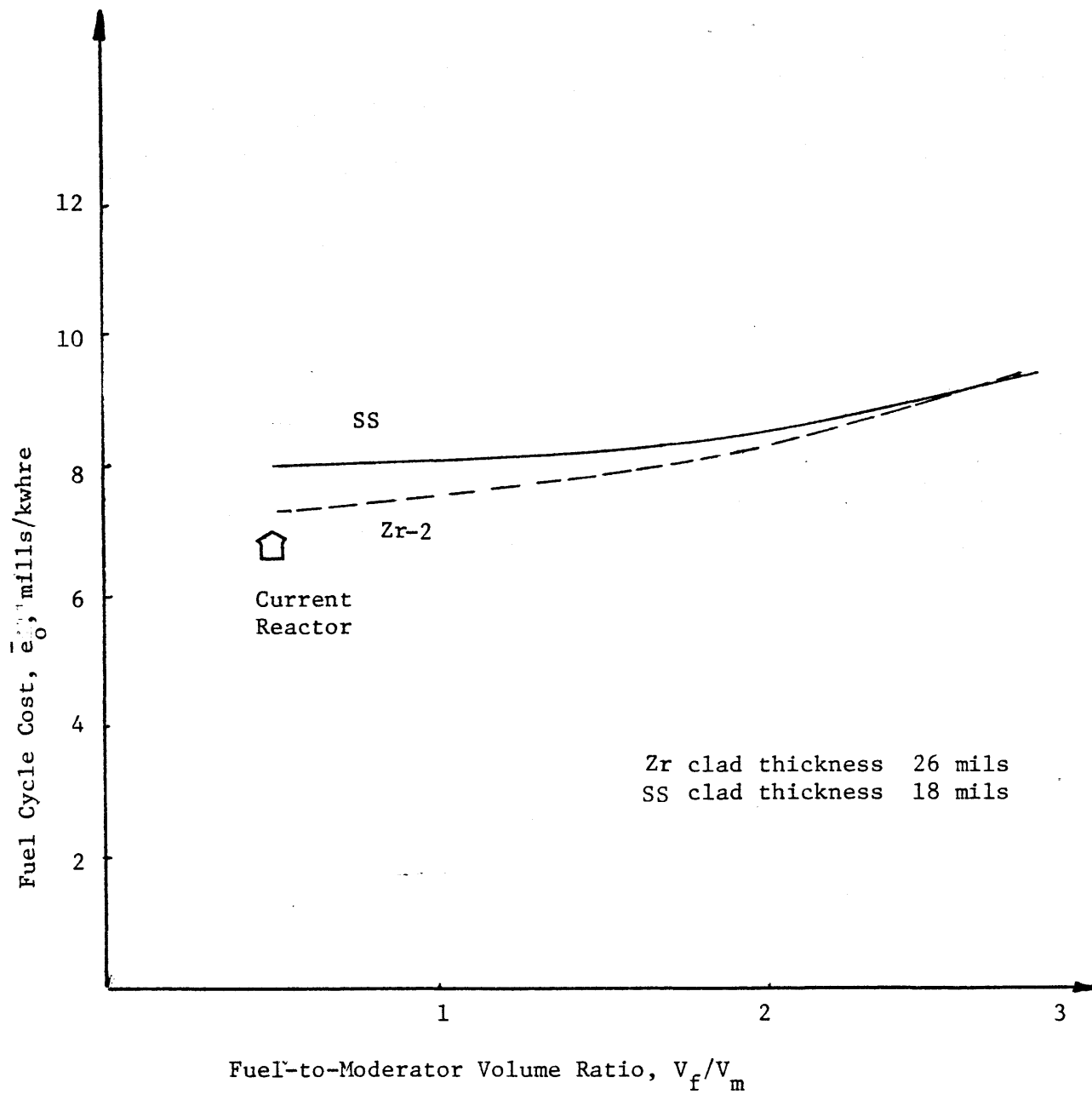

Figure 4.12 Comparison of Zircaloy and Stainless Steel Clad

discharged burnup is increased.

Considering the once-through mode of fuel cycle operation and the characteristics of the Maine Yankee Core, the mass flows charged and discharged can be obtained (Table (D-9)) for stainless steel clad and transaction quantities can be found by employing the equations given in Appendix E, as tabulated in Table (E-9). These quantities for zircaloy cladding are given in Table (E-6). Assuming 100 and 140 \$/Kg HM for the fabrication cost of stainless steel and zircaloy and the other unit prices as before, the fuel cycle cost can be obtained. Figure (4.13) shows the fuel cycle cost as a function of burnup for the two types of cladding. The ore usage was calculated as explained in Appendix F and, the result is also depicted in Figure (4.13). This figure shows that both fuel cycle cost and annual ore requirements are smaller for zircaloy cladding. However the optimum discharged burnup using stainless steel cladding is slightly higher: 45 GWD/MTHM and can be increased up to 52 GWD/MTHM without changing the minimum fuel cycle cost significantly, whereas for zircaloy cladding the discharged burnup can not be increased to more than 42 GWD/MTHM without sacrificing in terms of fuel cycle cost.

Figure (4-4) shows that increasing the number of batches from three to six increases the maximum discharged burnup (the burnup which can be increased without significant change in fuel cycle cost with respect to the minimum fuel cycle cost) by a factor of  $\sim 1.2$ . If we assume this factor can also be applied for stainless steel cladding, then for six batch cores using stainless steel clad the discharged burnup can be increased to  $\sim 62.5$  GWD/MTHM. Thus a combination of a six batch core and stainless steel cladding produces a cash flow pattern which favors higher burnup.



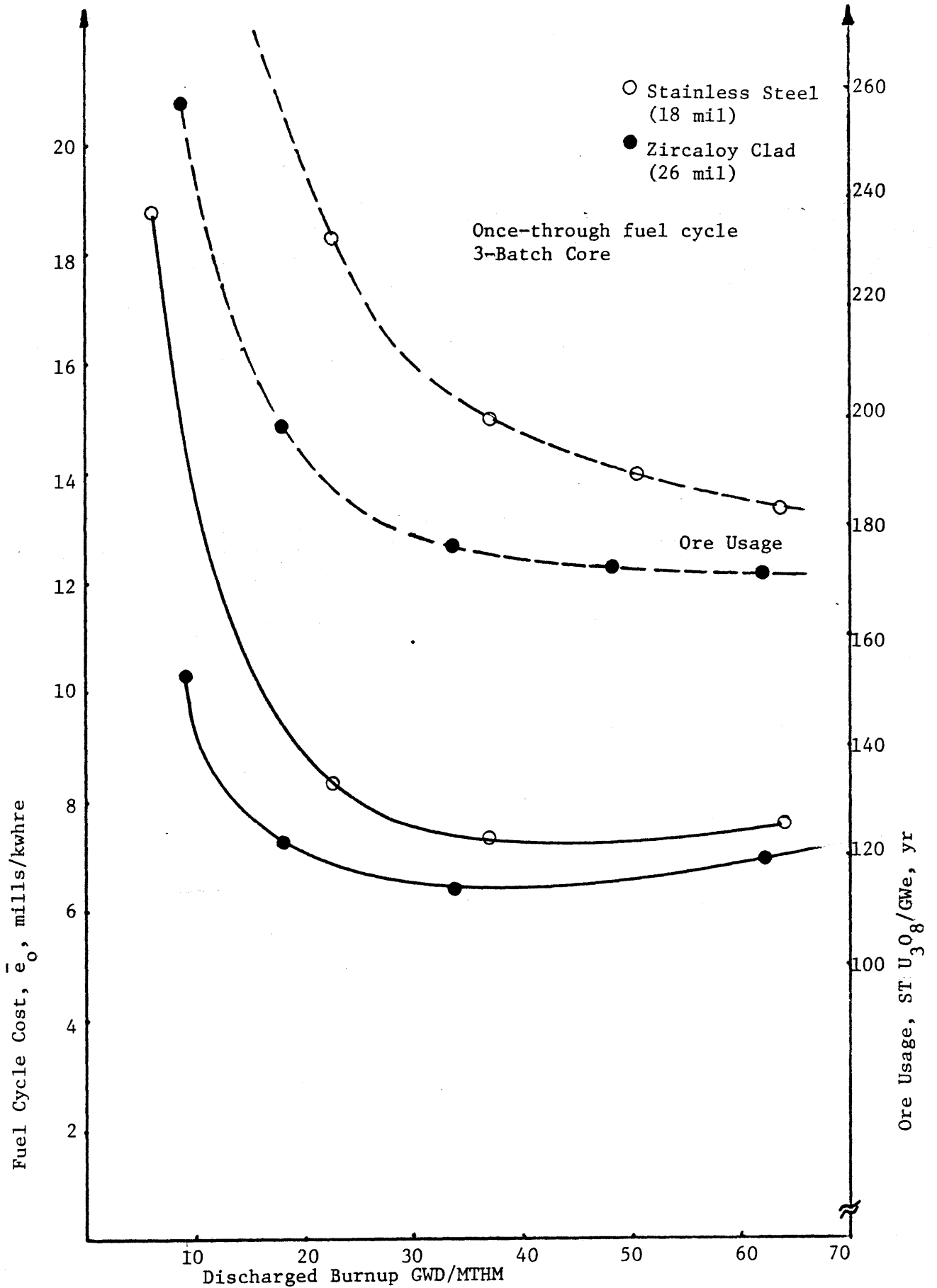

Figure 4.13 Fuel Cycle Cost and Ore Usage versus Burnup for Zircaloy and Stainless Steel Clad

## 4.8 Summary and Conclusions

### 4.8.1 Summary

Determination of the optimum discharged burnup was the main goal of this chapter. For this purpose, the characteristics of the Maine Yankee Core were again employed and the effect of the discharged burnup on the fuel cycle cost for the once-through fuel cycle and for the recycling mode were studied. The effect of increasing the number of batches on the fuel cycle cost and on the optimum discharged burnup were also considered. Increasing the discharged burnup increases the intra-refueling interval and hence increases the capacity factor. The capital cost and operating cost are inversely proportional to the capacity factor and thus as capacity factor is increased the busbar cost and total system cost decrease. Thus the effects of discharged burnup on the busbar cost and total system cost were studied and the optimum discharged burnup was determined in each case. The effect of the number of batches on busbar cost and total system cost were also determined.

Due to the uncertainty in the unit price of each step of the nuclear fuel cycle there is an uncertainty associated with the overall fuel cycle cost. A normal probability distribution function was assumed to be the representative of each individual fuel cycle cost component and the difference between the AIF consensus estimates of the highest and the lowest price of each transaction considered as two standard deviations. With this assumption and with the simple economic development in Chapter 2 the variance of the fuel cycle cost was calculated.

The effect of clad absorption on the economics of the PWR was also dealt with in this chapter. If all zircaloy neutron capture could be eliminated

there would be a 5% savings in ore usage for the once-through fuel cycle. Thus low absorption clad was considered to determine its effect on the fuel cycle cost and to obtain the maximum price of low absorption clad. The effect of stainless steel clad on the fuel cycle cost as the fuel-to-moderator volume ratio is increased was determined and compared to zircaloy clad.

Finally, different accounting treatments of the nuclear fuel, (1) all costs depreciated, (2) all steps expensed and (3) front end steps depreciated and back-end steps expensed (similar to the current financial policy of some US public utilities) were considered and compared.

#### 4.8.2 Conclusions

The main conclusions of this chapter, particularly with respect to the effect of discharged burnup can be categorized as;

- (1) The optimum discharged burnup for the three and six batch cores operating in the once-through mode of the fuel cycle are  $\sim 33000$  MWD/MTHM and  $\sim 42000$  MWD/MTHM, respectively.
- (2) The optimum discharged burnup for the three and six batch cores operating in the recycling mode of the fuel cycle are  $\sim 33000$  MWD/MTHM and  $\sim 35000$  MWD/MTHM, respectively.
- (3) The optimum discharged burnup of the recycling mode is lower than for the once-through mode.
- (4) Increasing the number of core batches increases the optimum discharged burnup.
- (5) The minimum fuel cycle cost for the once-through fuel cycle is greater than that for uranium and plutonium recycle. However, the difference is not very large ( $\sim 6\%$  for three batch core) and well within the uncertainties involved.

- (6) Increasing the number of core batches decreases the fuel cycle cost, so that the six batch core operating in the once-through mode for discharged burnups greater than 20000 MWD/MTHM has a smaller fuel cycle cost than that of the three batch core in the recycling mode. If each scenario is operated at its optimum discharged burnup, the fuel cycle cost is 5.1 mills/kwhre for the six batch core operating in the once-through mode and 5.4 mills/kwhre for the three batch core operating in the recycling mode.
- (7) The annual ore usage increases with increasing burnup for the recycling mode, whereas it decreases with increasing discharged burnup for the once-through mode. Increasing the number of core batches decreases the ore usage. These results agree with the paralled analysis by Correa (C-2).
- (8) The standard deviations of the fuel cycle cost due to the uncertainty of the unit prices of the sequential transactions in the fuel cycle are on the average 1.4 mills/kwhre for the once-through mode and the recycling mode.
- (9) Variation of the scarcity-related escalation rate for the price of ore does not change the optimum discharged burnup.
- (10) Reducing the refueling interval from 6.5 weeks to 3 weeks causes the minimum fuel cycle cost of the six batch core to decrease  $\sim$ 8.5% and 6.8% for recycling and once-through modes respectively.
- (11) Minimizing the busbar cost causes the optimum discharged burnup to shift to higher values. Consideration of total system cost shifts the optimum even higher. Thus it appears safe to say that

pursuit of high burnup to the limits of material and fuel design technology is economically justified. It also appears advantageous to use at least part of the increased burnup capability to increase the number of batches used in the core.

- (12) If a 50% decrease in zircaloy absorption can be achieved, a cost increment on the price of zircaloy of 11 \$/Kg could be tolerated.
- (13) Increasing both fuel-to-moderator volume ratio and discharged burnup make stainless steel more attractive as a clad material for PWRs but not economically superior to zircaloy under conditions now foreseen.
- (14) Treating the front end steps of the fuel cycle as a depreciable investment and the back end steps as expenses gives the highest fuel cycle cost (by a narrow margin), whereas expensing all steps gives the lowest fuel cycle cost among the three cases which have been studied. Finally, the optimum burnup stays the same as for the wholly depreciated case, whereas it increases for the wholly expensed case.

## CHAPTER 5

## SUMMARY, CONCLUSIONS AND RECOMMENDATIONS

## 5.1 Introduction

LWRs operating on the once-through fuel cycle are the only reactors licensed for commercial production of nuclear power at the present time in the United States. Thus a growing effort has been focused on improving the core design and fuel cycle performance of LWRs. Since on the order of 2/3 of the LWRs worldwide are PWRs, consideration in the present work is concentrated on current-design PWR cores, and a limited number of improved versions (chiefly tight pitch) and fuel management schemes (mainly increased burnup and more core batches). Previous work at MIT has been mainly concerned with improving the ore utilization of the PWR (G-1), (F-3). The present report analyzes the same designs and operational scenarios from the point of view of fuel cycle economics.

Although a major objective of the present work has been to analyze a broad spectrum of options on a self-consistent basis, the primary emphasis has been on aspects of contemporary interest: the once-through PWR fuel cycle in particular. Similarly, while the thorium fuel cycle was also examined, the uranium fuel cycle was emphasized.

In this report, the effect of fuel-to-moderator volume ratio and discharged burnup on the fuel cycle cost of a representative PWR, namely the Maine Yankee reactor, were studied. To achieve this goal a simple, economic model was derived. Finally the relative economic merits of zircaloy and stainless steel clad, and a number of other points, have been examined.

In this chapter we review the results which have been described in the previous chapters and highlight the conclusions which have been drawn. Recommendations for further work are also presented.

## 5.2 Summary and Conclusions

To permit rapid economic analysis of the PWR fuel cycle a Simple Model has been derived. This model is based on two main assumptions. First, only equilibrium batches, the batches which have equal residence time in the core and equal feed and discharged enrichment were considered, and the effects of startup and shutdown batches were ignored. Secondly, the revenue from the sale of electricity and depreciation charges were assumed to occur at the mid-point of the irradiation interval. On these bases, the model becomes:

$$e_o = \frac{1}{1000 E} \sum_{i=1}^I M_i C_i F_i G_i \quad (5.1)$$

where,

$$F_i = \frac{(P/F, x, t_i)}{(P/F, x, t_{r/2})} \left( \frac{1}{1-\tau} \right) - \left( \frac{\tau}{1-\tau} \right) \quad (5.2)$$

$$G_i = \left[ \frac{(P/F, y_e, t_{r/2})}{(P/F, y_i, t_i)} \right] \left[ \frac{(P/A, Z_i, Nt_c)}{(P/A, Z_e, Nt_c)} \right] \left[ \frac{(P/A, Z_e, t_c)}{(P/A, Z_i, t_c)} \right] \quad (5.3)$$

and the parameters are defined as;

$M_i$  = transaction quantity involved in the  $i^{\text{th}}$  step  
(e.g. Kg SWU or HM)

$C_i$  = unit price (e.g. \$/Kg or \$/lb) of the  $i^{\text{th}}$  step in  
time-zero dollars

$t_i$  = lag or lead time for step  $i$  relative to the start of  
irradiation (if step  $i$  is in the back end of the fuel  
cycle the irradiation time must be added), yr

$x$  = discount rate =  $(1 - \tau)f_b r_b + f_s r_s$ , %/yr/100

$Y_i$  = escalation rate for  $i^{\text{th}}$  step %/yr/100

$Y_e$  = escalation rate for the price of electricity, %/yr/100

$Z_i = (x - Y_i)/(1 + Y_i)$

$N$  = total number of steady state batches during the life of  
the reactor

$t_c$  = intra-refueling interval, yr

$t_r$  = residence time of a batch in the core, yr

$E$  = total electrical energy produced by a batch during  
its residence time in the core, kWhre

$\tau$  = tax fraction

$f_b$  = debt fraction

$f_s$  = equity fraction =  $1 - f_b$

$r_b$  = rate of return to bond holders, %/yr/100

$r_s$  = rate of return to stock holders %/yr/100

$I = 1, 2, 3, \dots I$ , the number of transactions

$$(P/F, x, t) = (1 + x)^{-t}$$

$$(P/A, Z, t) = [(1 + Z)^t - 1]/[Z(1 + Z)^t]$$



The discrepancy between this model and an accurate model such as MITCOST-II is not greater than +3% at the most for a typical PWR, close enough for the purposes of this task. Table 5.1 shows the good agreement between the simple model and MITCOST-II for various parameters of interest.

The above formulation treated the nuclear fuel as a depreciable investment. If the nuclear fuel, or any transaction therein, is expensed the  $F_i$  factor in Equation (5.1) becomes

$$F_i = \frac{(P/F, x, t_i)}{(P/F, x, t_r/2)} \quad (5.4)$$

To study the effect of fuel-to-moderator volume ratio and discharged burnup, the Maine Yankee core was selected as a reference case and the simple economic model was employed to determine the overall levelized fuel cycle cost.

Two coupled systems, namely  $^{235}\text{U}/^{238}\text{U}$  units coupled to Pu/U units and  $^{235}\text{U}$  (93%)/ $^{232}\text{Th}$  units coupled to  $^{233}\text{U}/\text{Th}$  units were considered to study the effect of fuel-to-moderator volume ratio. The latter coupled system was considered for both segregated and non-segregated cases. In the segregated case the  $^{235}\text{U}$  and  $^{233}\text{U}$  can be separated from each other, whereas for the non-segregated case these two fissile materials are intermixed. The once-through fuel cycle was also considered. To calculate the fuel cycle cost of these systems the recent consensus unit prices, published by the Atomic Industrial Forum (A-2) were used in most instances, however some unit prices were selected from other references (K-2)(A-3).

The minimum fuel cycle cost of the  $^{235}\text{U}/\text{U}:\text{Pu}/\text{U}$  system on the once-through fuel cycle is at a fuel-to-moderator volume ratio of 0.5, whereas

TABLE 5.1

## COMPARISON OF MITCOST AND SIMPLE MODEL FOR SEVERAL PARAMETRIC VARIATIONS

<u>Parameter Varied From the Case Base</u>	<u>Value Used</u>	$\bar{e}_o$ <u>MITCOST-II</u>	$\bar{e}$ <u>Simple Model</u>	<u>% Difference*</u>
Discount Rate	0.05	5.002	4.888	-2.28%
	0.14	6.992	6.794	-2.83%
Unit Price of $U_3O_8$	15 \$/lb	4.256	4.132	-2.93%
	55 \$/lb	7.471	7.302	-2.29%
	90 \$/lb	10.288	10.076	-2.06%
Lead Time for Purchasing $U_3O_8$	- 2 years	6.327	6.157	-2.68%
Lag Time for Reprocessing	4.0 years	5.921	5.802	-2%
	8.0 years	5.967	5.873	-1.57%
Availability Based Capacity Factor	0.54	6.531	6.412	-1.83%
	0.95	5.756	5.608	-2.57%
Tax Rate	0.0	5.186	5.015	-3.3%

$$*Diff = [(e_{S.M.} - e_{MITCOST}) / e_{MITCOST}] 100$$

for the  $^{235}\text{U}/\text{Th} : ^{233}\text{U}/\text{Th}$  combination (for both segregated and non-segregated cases) the minimum fuel cycle cost is at a fuel-to-moderator volume ratio equal to 0.6. Keeping the fuel-to-moderator volume ratio of the producer reactor constant causes the fuel cycle cost of the coupled system to be insensitive to variation of the fuel-to-moderator volume ratio of the consumer reactor. Hence operating the producer reactor at its optimum fuel-to-moderator ratio (0.5 for both  $^{235}\text{U}/\text{U}$  and  $^{235}\text{U}/\text{Th}$  units) gives a fuel cycle cost of the coupled system very close to the minimum fuel cycle cost and allows one to increase the fuel-to-moderator volume ratio of the consumer reactor for other objectives such as minimizing ore consumption.

The scarcity-related escalation rate for ore price (or changes in ore cost) do not affect the optimum fuel-to-moderator volume ratio. If each coupled cycle has its optimum fuel-to-moderator volume ratio the fuel cycle cost of a  $^{235}\text{U}/\text{U} : \text{Pu}/\text{U}$  system has a smaller value for all escalation rates than the fuel cycle cost of a  $^{235}\text{U}/\text{Th} : ^{233}\text{U}/\text{Th}$  system. Even for the optimum fuel-to-moderator volume ratio, the once-through uranium fuel cycle has a smaller fuel cycle cost than does the  $^{235}\text{U}/\text{Th} : ^{233}\text{U}/\text{Th}$  system with recycle. Thus even though a near-breeder capability is possible with advanced  $^{233}\text{U}/\text{Th}$  cores, it will be difficult to induce utilities to adopt the necessary prebreeder phase based on current economics. Tables (5-2) through (5-4) show the fuel cycle cost and annual ore usage for  $^{235}\text{U}(93\%)/\text{Th} : ^{233}\text{U}/\text{Th}$  systems,  $^{235}\text{U}/\text{U} : \text{Pu}/\text{U}$  systems and the once-through uranium-fuel cycle for different fuel-to-moderator volume ratios. As shown in these tables, from the economic point of view there is no cost advantage for the thorium cycle. The optimum fuel-to-moderator volume ratios of the  $^{235}\text{U}/\text{Th} : ^{233}\text{U}/\text{Th}$  system for segregated and non-segregated cases are the same, however the fuel cycle cost of the non-segregated case is slightly

TABLE 5-2  
 OVERALL LEVELIZED FUEL CYCLE COST OF  $^{235}\text{U}(93\%)/^{232}\text{Th}$  REACTORS  
 COUPLED WITH  $^{233}\text{U}/^{232}\text{Th}$  REACTORS

$V_f/V_m$ Producer $^{235}\text{U}(93\%)/^{232}\text{Th}$	$V_f/V_m$ Consumer $^{233}\text{U}/^{232}\text{Th}$	$\bar{e}_o$ Overall Levelized Fuel Cycle Cost (mills/kwhre)	Ore Requirement* ST $\text{U}_3\text{O}_8/\text{GWe/yr}$
0.338	0.338	8.50	105.32
0.338	0.4816	8.40	97.23
0.338	0.9161	8.33	89.36
0.338	1.496	8.42	84.98
0.4816	0.338	8.23	98.32
0.4816	0.4816	8.10	90.53
0.4816	0.9161	<u>8.06</u>	82.99
0.4816	1.496	8.13	78.80
0.9161	0.338	8.64	95.90
0.9161	0.4816	8.53	87.83
0.9161	0.9161	8.44	80.12
0.9161	1.496	8.66	<u>75.85</u>
1.496	0.338	10.3	101.51
1.496	0.4816	10.1	92.45
1.496	0.9161	10.0	83.87
1.496	1.496	10.1	79.20

\*For 0%/yr system growth rate and 0.2% tail assay of separation plant

TABLE 5.3

OVERALL LEVELIZED FUEL CYCLE COST OF  $^{235}\text{U}/^{238}\text{U}$  UNITS  
 COUPLED WITH  $\text{Pu}/^{238}\text{U}$  UNITS

$V_f/V_m$ Producer $^{235}\text{U}/^{238}\text{U}$	$V_f/V_m$ Consumer $\text{Pu}/^{238}\text{U}$	$\bar{e}_o$ overall levelized fuel cycle cost (mills/kwhr)	Ore Requirement* $\text{ST U}_3\text{O}_8/\text{GWe, yr}$
0.338	0.338	6.60	130.53
0.338	0.4816	6.58	126.02
0.338	0.9161	6.80	137.11
0.338	1.496	6.81	137.53
0.4816	0.338	6.21	114.63
0.4816	0.4816	<u>6.19</u>	110.17
0.4816	0.9161	6.40	121.99
0.4816	1.496	6.42	122.45
0.9161	0.338	7.30	105.56
0.9161	0.4816	7.20	<u>99.45</u>
0.9161	0.9161	7.79	116.18
0.9161	1.496	7.81	116.88
1.496	0.338	9.30	111.18
1.496	0.4816	9.20	103.36
1.496	0.9161	10.35	125.30
1.496	1.496	10.40	126.25

\*For zero system growth rate and 0.2% tail assay of separation plant

TABLE 5-4

## ORE USAGE AND FUEL CYCLE COST FOR THE ONCE-THROUGH FUEL CYCLE

$\frac{V_f}{V_m}$	$\bar{e}_o$ mills/kwhre		$U_3O_8$ Requirement* (ST/GWe-yr)
	<u>Disposal</u>	<u>Storage &amp; Disposal</u>	
0.338	6.36	6.67	190.40
0.4816	6.06	6.37	181.15
0.9161	8.45	8.75	255.3
1.497	13.25	13.55	401.7

\* 0%/yr system growth rate and 0.2% tail assay of separation plant

greater than for the segregated case shown in Table 5-2. Thus the more practical option for the thorium cycle, namely the non segregated case, shows even less promise.

Based on the concept of indifference value, correlations for the unit price of fissile plutonium and fissile  $^{233}\text{U}$  were derived; these correlations are:

$$C_{\text{Pu}} = 0.561 e^{0.12y} C_{\text{U}_3\text{O}_8}(\text{o}) + 0.178 C_{\text{SWU}}(\text{o}) - 13.9, \text{ \$/gr} \quad (5.5)$$

$$C_{\text{U-3}} = 0.663 e^{0.10y} C_{\text{U}_3\text{O}_8}(\text{o}) + 0.318 C_{\text{SWU}}(\text{o}) - 13.72, \text{ \$/gr} \quad (5.6)$$

where

$C_{\text{Pu}}$  = unit price of fissile material, \\$/gr

$C_{\text{U}_3\text{O}_8}(\text{o})$  = unit price of  $\text{U}_3\text{O}_8$       \\$/lb, time zero dollars

$C_{\text{SWU}}(\text{o})$  = separative work cost, \\$/KgSWU, time zero dollars

$y$  = scarcity-related escalation rate for ore price, %/yr

Increasing the discharged burnup decreases both the annual ore usage and the fuel cycle cost (up to a point) for the once-through fuel cycle; however increasing the discharged burnup increases the annual ore usage for the recycling mode (unless, the number of core batches is increased). Tables 5.5 and 5.6 show the fuel cycle cost and annual ore usage for different discharged burnups for the once-through and recycling modes for three and six batch cores, respectively. The optimum discharged burnup for the three batch core is  $\sim 33000$  MWD/MTHM for both the once-through and recycling modes. Increasing the number of batches to six increases the optimum burnup to  $\sim 35000$  MWD/MTHM for the

TABLE 5.5

## FUEL CYCLE COST AND ANNUAL ORE USAGE FOR THE THREE BATCH CORE

Enrichment (w/o)	Discharged Burnup GWD/MTHM	Capacity Factor	ONCE-THROUGH		RECYCLING	
			$e_o$ mills/kwhre	Annual Ore Usage, ST/GWe-yr	$e_o$ mills/kwhre	Annual Ore Usage ST/GWe-yr
1.5	8.8	0.613	9.660	957.6	9.200	<u>87.26</u>
2.0	18.0	0.697	6.575	198.3	6.016	102.26
3.0	33.8	0.750	<u>5.790</u>	176.7	<u>5.395</u>	118.14
4.0	48.2	0.770	5.93	172.7	5.658	128.4
5.0	62.1	0.781	6.28	171.6	6.028	136.04
6.0	76.0	0.788	6.683	<u>171.1</u>	6.537	142.1



TABLE 5.6

## FUEL CYCLE COST AND ANNUAL ORE USAGE FOR THE SIX BATCH CORE

Enrichment (w/o)	Discharged Burnup GWD/MTHM	Capacity Factor	ONCE-THROUGH		RECYCLING	
			$e_o$ mills/kwhre	Annual Ore Usage, ST/GWe-yr	$e_o$ mills/kwhre	Annual Ore Usage ST/GWe-yr
1.5	10.1	0.502	8.56	183.75	7.909	<u>69.04</u>
2.0	21.0	0.629	5.787	153.60	5.023	87.39
3.0	39.6	0.706	<u>5.156</u>	142.01	<u>4.765</u>	103.26
4.0	56.6	0.737	5.347	140.8	5.033	112.98
5.0	73.0	0.754	5.716	140.65	5.509	120.07
6.0	90.5	0.766	6.104	<u>139.7</u>	5.994	125.31

recycling mode, whereas it increases to 42000 MWD/MTHM for the once through option. Considering the busbar cost or total system cost as the criterion (as a utility is want), shifts the optima to higher burnup. Table 5.7 shows the fuel cycle cost, busbar cost and the total system cost for different burnups, for the once-through fuel cycle and the three batch core. Figure (5-1) shows the fuel cycle cost and ore usage for the three and the six batch cores for both the once-through and recycling modes. The uncertainty flag represents one standard deviation. The standard deviation of the fuel cycle cost is on the average 1/4 mills/kwhre. The scarcity-related escalation rate for ore price has no effect on the optimum burnup.

Depreciating the front-end transactions and expensing the back-end transactions of the nuclear fuel cycle increases the minimum fuel cycle cost by 1.7% (three batch core, once-through fuel cycle.) whereas expensing all transactions decreases the minimum fuel cycle cost by 10.5%, with respect to depreciating all nuclear fuel transactions. Decreasing the refueling interval from 6.5 weeks to 3 weeks decreases the minimum fuel cycle cost of the six batch core ~8.5% and 6.8% for recycling and once-through modes, respectively. Zircaloy clad was found to always be more attractive than stainless steel clad from the point of view of economics. However, at high fuel-to-moderator volume ratio the difference is sufficiently small to make stainless steel clad attractive due to its better mechanical performance. Finally, although employing non-absorbing zircaloy decreases the ore usage 5% with respect to the case with no-isotopically separated zircaloy, this is worthwhile only if the price of sponge zirconium does not increase more than ~25 \$/Kg (for a 50% reduction in absorption).

TABLE 5.7

FUEL CYCLE COST, BUSBAR COST AND TOTAL SYSTEM COST  
FOR THE THREE BATCH CORE ON THE ONCE-THROUGH FUEL CYCLE

<u>Discharged Burnup MWD/MTHM</u>	<u>Capacity* Factor</u>	$e_o$ <u>Fuel Cycle Cost mills/kwhre</u>	$e_b^\dagger$ <u>Busbar Cost mills/kwhre</u>	$e_s^{\dagger\dagger}$ <u>Total System Cost mills/kwhre</u>
8800	0.613	9.66	30.91	32.39
18000	0.697	6.575	25.27	28.13
33800**	0.75	<u>5.79</u>	23.16	26.06
48200	0.77	5.938	<u>22.86</u>	25.59
62100	0.781	6.280	22.96	<u>25.54</u>
76000	0.788	6.683	23.22	25.66

\*Availability based capacity factor is 0.82

\*\*Reference case

†The fuel cycle cost was assumed to be 25% of the fixed cost of the reference case.

††The replacement cost was assumed to be 1.5 times the busbar cost of the reference case

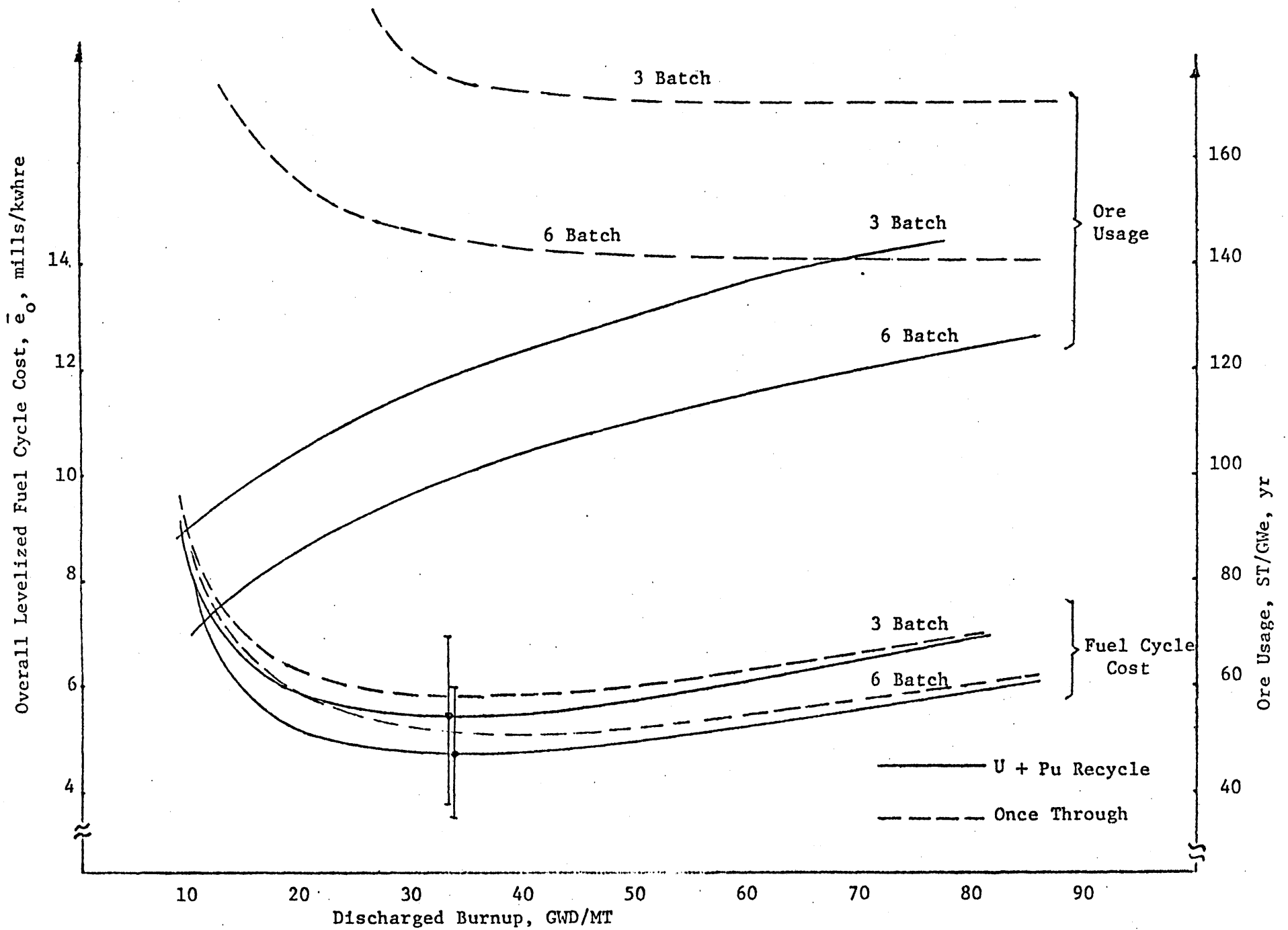

Figure 5.1 The Overall Levelized Fuel Cycle Cost and Ore Usage versus Burnup for the 3 and 6 Batch Cores

The overall conclusion of this analysis is that, from an economic standpoint, high burnup is an almost unmitigated benefit, particularly when accompanied by an increase in the number of core batches. When optimized under comparable ground rules, the recycle mode is economically preferable to the once-through mode, and requires less ore. Economic differences, however, are well within the uncertainty of cost estimation, and the once-through mode can not be said to be significantly inferior.

### 5.3 Recommendations for Further Work

Recommendations for further work are as follows:

1. The fuel cycle cost model should be improved to incorporate startup batches and to depreciate fuel to zero value on a routine basis. In this regard, Garel (G-1) has developed a simple way for estimating startup batch mass flows relative to those for steady state batches.
2. Key cost components, and especially their uncertainty ( $\pm\sigma$ ) should be better characterized, for example:
  - (a) our base case once-through calculations, for example, did not charge for interim storage on the basis that these charges might be absorbed into plant capital and O & M expenses and the necessary duration of such storage in the longer term is undefined. If the storage were included, the once-through fuel cycle cost would increase by about 5%.
  - (b) The cost premium required to fabricate fuel capable of very high burnup should be ascertained and employed in future analyses.

- (c) the costs of re-enriching irradiated uranium should be examined; if dedicated units are required a cost penalty should be imposed.
3. The most promising cycle scenarios should be given greater attention: namely an 18 month refueling cycle (hence 3 or 4 batches), on the once-through mode.
  4. Accounting and tax policies should be examined which will produce economic optimum operating points which favor improved ore utilization (i.e., increased burnup and more fuel batches on the once-through cycle).
  5. A more thorough and more complete set of consistent isotope worth factors should be developed.
  6. The model should be extended to routinely calculate (and optimize on the basis of) system cost, including the cost of replacement power during refueling.

One final observation: we have not found thorium-fuel systems to be economically attractive in the analyses reported here. However, a more comprehensive analysis of this fuel cycle is currently underway by Correa (C-2). Final conclusions on this issue should therefore be deferred. In addition we have considered only uniform lattices - our conclusions do not apply to the more elaborate high-performance seed and blanket designs, such as those used in the LWBR or its prebreeder phase.

## APPENDIX A

## DERIVATION OF PSEUDO-CASH-FLOW FORMULATION

The pseudo-cash-flow formulation used in this work to analyze fuel cycle costs is derived in References(S-1) and (O-1). However a condensed reiteration will be useful here. Consider the  $j^{\text{th}}$  year and assuming the remaining investment at the beginning of this year is  $V_{j-1}$ , the remaining investment at the end of the  $j^{\text{th}}$  year can be written as;

$$V_j = V_{j-1} - (F_j - T_j - D_j - R_j) \quad (\text{A.1})$$

where

$F_j$  = cash flow in year  $j$

$T_j$  = Income tax in year  $j$

$D_j$  = Depreciation allowance in year  $j$

$R_j$  = Required return to debt and equity

The income tax in year  $j$  is the product of tax rate and taxable income, where taxable income can be written as

$$\text{Taxable Income} = F_j - D_j - f_b r_b V_{j-1} \quad (\text{A.2})$$

where  $f_b$  and  $r_b$  are the bond fraction and the rate of return to the bondholder respectively. Thus income tax can be written as

$$T_j = \tau \cdot (F_j - D_j - f_b r_b V_{j-1}) \quad (\text{A.3})$$

Require return to debt and equity is

$$R_j = V_{j-1} \cdot r \quad (\text{A.4})$$

where

$$r = f_b r_b + f_s r_s \quad (\text{A.5})$$

$f_s$  and  $r_s$  are stock fraction and rate of return to stockholder.

Using Equations (A.3) and (A.4) in Equation (A.1) and employing Equation (A.5) for  $r$ , there results:

$$V_j = V_{j-1}(1 + x) - [(1 - \tau)F_j + \tau D_j] \quad (\text{A.6})$$

where  $x$  is designated the "discount rate" and is given by:

$$x = (1 - \tau) f_b r_b + f_s r_s \quad (\text{A.7})$$

Thus if at the beginning of the first year the investment is  $I_0$ , the investment at the end of year 1,  $V_1$  is

$$V_1 = I_0(1 + x) - [(1 - \tau)F_1 + \tau D_1] \quad (\text{A.8})$$

Similarly, the investment at the end of the second year can be written as

$$V_2 = V_1(1 + x) - [(1 - \tau)F_2 + \tau D_2] \quad (\text{A.9})$$

Inserting Equation (A.8) into Equation (A.9) gives



$$V_2 = V_0(1+x)^2 - [(1-\tau)F_1 + \tau D_1](1+x) - [(1-\tau)F_2 + \tau D_2] \quad (\text{A.10})$$

If we continue in this manner, the investment at the end of year  $n$ ,  $I_n$  can be written as

$$I_n = I_0(1+x)^n - \sum_{j=1}^n [(1-\tau)F_j + \tau D_j](1+x)^{n-j} \quad (\text{A.11})$$

Dividing each side by  $(1+x)^n$  and defining

$$(P/F, x, n) = (1+x)^n \quad (\text{A.12})$$

leads to

$$I_n(P/F, x, n) = I_0 - \sum_{j=1}^n [(1-\tau)F_j + \tau D_j](P/F, x, j) \quad (\text{A.13})$$

which is equivalent to a present worth analysis of a pseudo cash flow problem: where cash flow is weighted by  $(1-\tau)$  and when (tax-weighted) depreciated appears as a fictitious positive cash flow. Use of this approach makes analysis much simpler since taxes need not be explicitly considered.

## APPENDIX B

## SIMMOD PROGRAM

In this appendix the Computer program which has been written to incorporate the simple economic model is discussed. The definitions of the parameters involved and a prescription for input data are as follows:

## Card 1:

Column 1 - 2 (I2)	Option for treatment of nuclear fuel
	01, nuclear fuel depreciated
	02, nuclear fuel expensed
	03, front end depreciated and back end expensed

## Card 2:

Column 1 - 2 (I2)	Number of steady state batches, NB
Column 3 - 4 (I2)	Number of transactions, NT

## Card 3:

Column 1 - 10 (F10.0)	Debt fraction, BF
Column 11 - 20 (F10.0)	Equity fraction, SF
Column 21 - 30 (F10.0)	Rate of return to bond holder, BR %/yr/100
Column 31 - 40 (F10.0)	Rate of return to stockholders, SR %/yr/100
Column 41 - 50 (F10.0)	Overall tax fraction, TAX %/yr/100

## Card 4:

Column 1 - 10, (F10.0)	Intra refueling interval, TC, yr
Column 11 - 20, (F10.0)	Irradiation time, TR, yr
Column 21 - 30, (F10.0)	Escalation rate for electricity, YE, %/yr/100

## Card 5:

Column 1 - 10, (F10.0)	Heat rate, HR, MWth
Column 11 - 20, (F10.0)	Efficiency, ETA
Column 21 - 30, (F10.0)	Capacity factor, CAPA

## Card 6:

Absolute lead (negative) or lag (positive) time,  
for each step of the nuclear fuel cycle, T(I), yr

Column 1 - 10, (F10.0)	T(1)
Column 11 - 20, (F10.0)	T(2)

.

.

.

(Go to next card if number of transactions is greater than 8)

NOTE: DO NOT ADD Irradiation time to lag time

## Card 7:

Transaction quantities of each step of fuel cycle XMASS(I)

Column 1 - 10, (F10.0)	XMASS(1)
Column 11 - 20, (F10.0)	XMASS(2)

.

.

.

(Go to next card if number of transactions is greater than 8)

Card 8:

Escalation Rate for each step of nuclear fuel cycle,  $y(I)$ ,

%/yr/100

Column 1 - 10, (F10.0)       $y(1)$

Column 11 - 20, (F10.0)      $y(2)$

.

.

.

(go to next card if number of transactions is greater than 8)

Card 9:

Unit price for each step of nuclear fuel cycle (CI)

Column 1 - 10, (F10.0)       $C(1)$

Column 11 - 20, (F10.0)      $C(2)$

.

.

.

(go to next card if the number of transactions is greater than 8)

NOTE: Unit of  $XMASS(I)*C(I)$  must be in dollars.

The listing of SIMMOD is shown. The print out contains the following information : transaction quantity, unit price, direct cost ( $X_{MASS}(I)*C(I)$ ), escalation rate, the  $F(I)$  and  $G(I)$  factors in the Simple Model, the partial cost of each step ( $BR.D$ ), the overall levelized fuel cycle cost (mills/kwhre) discount rate ( $DISRA$ ), total energy produced per batch ( $E$ ) and finally a repetition of the input data. The print out of SIMMOD for the base case studied in Chapter 2 is appended.

```

DIMENSION VFCF(5),Y(15),T(15),XMASS(15,5),PROD(15,5),C(15),F(15),G
*(15),ULEVC(5),NO(15),VFVC(5),BRD(15,5),EP(15,5)
99 FFORMAT(2I2)
98 FFORMAT(4I2)
97 FFORMAT(8F10.0)
96 FFORMAT(////45X,'** MISCELLANEOUS FINANCIAL INFORMATION **')
95 FFORMAT(/5X,'INCOME TAX=',F10.5,/5X,'BOND FRACTION=',F10.5,/5X,'STO
*CKE FRACTION=',F10.5,/5X,'RATE OF RETURN TO BOND=',F10.5,/5X,'RATE
* OF RETURN TO STOCK=',F10.5,//5X,'DISCOUNT RATE=',F10.5)
94 FFORMAT(////45X,'ENERGY INFORMATION')
93 FFORMAT(/5X,'HEAT RATE=',F10.4,'(MWT)',/5X,'EFFICIENCY=',F10.5,/5X,
*'CAPACITY FACTOR=',F10.5,/5X,'TOTAL ENERGY PRODUCTION FOR A BATCH
*DURING RESIDENCE IN CORE =' ,E14.6,'(KWH)' )
92 FFORMAT(////5X,'TC=',F10.4,/5X,'TR=',F10.4,/5X,'NUMBER OF BATCH=',
*I2,/5X,'ESCALA. FOR ELEC. =' ,F10.5,/5X,'NUMBER OF TRANSACTION=',I2
*,/5X,'NV=',I2)
90 FFORMAT( //2X,'STEP',6X,'QUANTITY',8X,'UNIT COST',5X,'DIRECT COST
*',8X,'LAG TIME',6X,'Y(I)',6X,'G(I)',6X,'F(I)',5X,'BR.C.(MILL/KWH)
*',//)
89 FFORMAT((3X,I2,3X,E14.6,4X,F12.3,3X,E14.6,5X,F9.5,5X,F6.4,4X,F8.4,3
*X,F8.6,7X,F10.6//)
88 FFORMAT(////30X,'THE OVERALL LEVELIZED FUEL CYCLE COST=',F12.7,'(MI
*LL/KWH)',/29X,'
* ')
READ(5,98)ICP
READ(5,99)NB,NT
NV=1
READ(5,97)BF,SF,BR,SR,TAX
READ(5,97)TC,TR,YE
READ(5,97)HEATR,ETA,CAPA
READ(5,97)((XMASS(I,J)),I=1,NT),J=1,NV)
READ(5,97)(T(I),I=1,NT)
READ(5,97)(Y(I),I=1,NT)
READ(5,97)(C(I),I=1,NT)
C CALCULATION OF ENERGY PRODUCTION
E=ETA*HEATR*CAPA* TC *8766.CE+03
C CALCULATION OF DISCOUNT RATE
DISRA=(1.0-TAX)*BR*BF+SR*SF
TR2=TR/2.0
BN=NB
TCN=TC*BN
DO 10 I=1,NT
YY=Y(I)
IF(T(I)-0.0)201,201,202
201 TT=T(I)
GO TO 203
202 TT=T(I)+TR
203 CONTINUE
IF(ICP.EQ.3) GO TO 302
IF(ICP.EQ.1) GO TO 300
IF(ICP.EQ.2) GO TO 301
302 IF(T(I)-0.0)300,300,301
300 F(I)=1.0/(1.0-TAX)*PWF(DISRA,TT)/PWF(DISRA,TR2)-TAX/(1.0-TAX)
GO TO 400
301 F(I)=PWF(DISRA,TT)/PWF(DISRA,TR2)
400 CONTINUE
IF((YE.EQ.DISRA).AND.(Y(I).EQ.DISRA)) GO TO 15
IF(YE.EQ.DISRA) GO TO 16

```

EVEL 01

MAIN

DATE = 79016

09/27/08

```

IF(Y(I).EQ.DISRA) GO TO 17
G(I)=PWF(YE,TR2)/PWF(YT,TT)*(1.0-PWF(DISRA,TCN)/PWF(YT,TCN))/(1.0-
*PWF(DISRA,TC)/PWF(YT,TC))*(1.0-PWF(DISRA,TC)/PWF(YE,TC))/(1.0-PWF(
*DISRA,TCN)/PWF(YE,TCN))
GO TO 10
15 G(I)=PWF(YE,TR2)/PWF(YT,TT)
GO TO 10
16 G(I)=PWF(YE,TR2)/PWF(YT,TT)*(1.0-PWF(DISRA,TCN)/PWF(YT,TCN))/(1.0-
*PWF(DISRA,TC)/PWF(YT,TC))/BN
GO TO 10
17 G(I)=PWF(YE,TR2)/PWF(YT,TT)*(1.0-PWF(DISRA,TC)/PWF(YE,TC))/(1.0-PW
*F(DISRA,TCN)/PWF(YE,TCN))*DN
10 CONTINUE
WRITE(6,96)
WRITE(6,95)TAX,BF,SF,BK,SR,DISRA
WRITE(6,94)
WRITE(6,93)HEATR,ETA,CAPA,E
WRITE(6,92)TC,TR,NS,YE,NT,NV
DO 11 J=1,NV
UC=0.0
DO 12 I=1,NT
PRCD(I,J)=C(I)*XMASS(I,J)
BRD(I,J)=F(I)*C(I)*PRCD(I,J)
EB(I,J)=BRD(I,J)/E*1000.0
12 UC=UC+PRD(I,J)
11 UL=VC(J)=UC/E*1000.0
DO 13 I=1,NT
13 NC(I)=I
DO 14 J=1,NV
WRITE(6,90)
WRITE(6,91)(NC(I),XMASS(I,J),C(I),PRCD(I,J),T(I),Y(I),G(I),F(I),EB
*(I,J),I=1,NT)
14 WRITE(6,92)UL=VC(J)
50 CONTINUE
END

```

VEL 21

MAIN

DATE = 79010

```

THIS FUNCTION IS FOR CALCULATING OF PRESENT WLRTH FACTOR
FUNCTION PWF(X,T)
PWF=1.0/(1.0+X)**T
RETURN
END

```

**\*\* MISCELLANEOUS FINANCIAL INFORMATION \*\***

INCOME TAX= 0.50000  
BOND FRACTION= 0.50000  
STOCK FRACTION= 0.50000  
RATE OF RETURN TO BOND= 0.08000  
RATE OF RETURN TO STOCK= 0.14000  
  
DISCOUNT RATE= 0.09000

**ENERGY INFORMATION**

HEAT RATE= 3800.0000(MWT)  
EFFICIENCY= 0.34200  
CAPACITY FACTOR= 0.75000  
TOTAL ENERGY PRODUCTION FOR A BATCH DURING RESIDENCE IN CORE = 0.841520E 10(KWHE)

TC= 0.9849  
TR= 2.8297  
NUMBER OF BATCH=30  
ESCALA. FOR ELEC. = 0.0  
NUMBER OF TRANSACTION=11  
NV= 1



STLP	QUANTITY	UNIT COST	DIRECT COST	LAG TIME	Y(I)	G(I)	F(I)	BR.D.(MILL/KWHE)
1	0.500527E 06	35.000	0.175184E 08	-1.04670	0.0	1.0000	1.472611	3.065622
2	0.191548E 06	4.000	0.766192E 06	-0.54170	0.0	1.0000	1.367314	0.124492
3	0.152106E 06	85.000	0.129290E 08	-0.54170	0.0	1.0000	1.367314	2.100722
4	0.337639E 05	101.000	0.341015E 07	-0.20830	0.0	1.0000	1.300265	0.526915
5	0.337639E 05	15.000	0.506458E 06	0.50000	0.0	1.0000	0.695760	0.041873
6	0.337639E 05	150.000	0.506458E 07	0.75000	0.0	1.0000	0.659617	0.396982
7	0.337639E 05	100.000	0.337639E 07	0.75000	0.0	1.0000	0.659617	0.264655
8	0.112400E 06	-35.000	-0.393610E 07	1.00000	0.0	1.0000	0.624244	-0.291982
9	0.430376E 05	-4.000	-0.172150E 06	1.00000	0.0	1.0000	0.624244	-0.012770
10	0.589590E 04	-85.000	-0.501156E 06	1.00000	0.0	1.0000	0.624244	-0.037176
11	0.230000E 03	-27140.000	-0.624220E 07	1.00000	0.0	1.0000	0.624244	-0.463049

THE OVERALL LEVELIZED FUEL CYCLE COST= 5.7162790(MILL/KWHE)

---

## APPENDIX C

## MODIFICATION OF MITCOST-II

As mentioned in Chapter 2, MITCOST-II as originally written is not able to calculate the fuel cycle cost of the once-through mode of fuel cycle operation. Two approaches were employed to equip this code for fuel cycle cost calculations of the non-recycle mode.

In the first approach no programming modification is necessary, and the code can be run for the non recycle mode through use of fictitious input. That is, the fractional uranium recovery in reprocessing,  $f$ , can be put equal to a small number, in our case  $10^{-2}$  (note that the code does not accept zero).

In the second approach, a programming modification is necessary. The parameters  $Z(15,3)$ ,  $Z(16,3)$  and  $Z(17,3)$  (see code description by Croff (C-3)) must be set equal to zero where they appear in the code.

Figures (C-1) and (C-2) show the fuel cycle cost for a representative batch for the first and second approaches, respectively. The small credits in Steps 15, 16 and 17 in the first case are negligible for all practical purposes: as can be seen the levelized cost is affected to only 1 part in 10,000.

NO	TRANSACTION	DIRECT COST	DISCOUNTED COST
01	PAY FOR U308 (YELLOWCAKE)	\$ 8.911824E+06	\$ 9.781892E+06
02	PAY FOR CONVERSION OR COST OF UF6	\$ 3.897697E+05	\$ 4.090197E+05
03	PAY FOR SEPARATIVE WORK	\$ 4.425335E+06	\$ 4.643894E+06
04	PAY FOR PLUTONIUM	\$ 0.0	\$ 0.0
05	PAY FOR THORIUM	\$ 0.0	\$ 0.0
06	PAY FOR U-233	\$ 0.0	\$ 0.0
07	PAY FOR FABRICATION	\$ 3.410161E+06	\$ 3.473982E+06
08	PAY FOR SHIPPING FUEL TO REACTOR	\$ 0.0	\$ 0.0
09	PAY FOR	\$ 0.0	\$ 0.0
10	PAY FOR	\$ 0.0	\$ 0.0
11	PAY FOR SHIPPING FUEL TO REPROCESSING	\$ 5.044106E+06	\$ 4.469123E+05
12	PAY FOR REPROCESSING	\$ 0.0	\$ 0.0
13	PAY FOR WASTE DISPOSAL	\$ 5.044106E+06	\$ 4.370786E+06
14	PAY FOR CONVERSION OF UNH TO UF6	\$ 0.	\$ 0.0
15	CREDIT FOR U308	\$ - 3.207715E+02	\$ - 2.718367E+02
16	CREDIT FOR CONVERSION OR FOR UF6	\$ - 1.402935E+-1	\$ - 1.188913E+01
17	CREDIT FOR SEPARATIVE WORK	\$ - 6.955375E+00	\$ - 5.894312E+00
18	CREDIT FOR PLUTONIUM	\$ 0.0	\$ 0.0
19	CREDIT FOR THORIUM	\$ 0.0	\$ 0.0
20	CREDIT FOR U-233	\$ 0.0	\$ 0.0
21	PAY FOR	\$ 0.0	\$ 0.0
22	PAY FOR	\$ 0.0	\$ 0.0
23	CREDIT OR PENALTY FOR	\$ 0.0	\$ 0.0
24	CREDIT OR PENALTY FOR	\$ 0.0	\$ 0.0
25	CREDIT OR PENALTY FOR	\$ 0.0	\$ 0.0

THE LEVELIZED UNIT NUCLEAR FUEL COST PER BATCH = 9.095914

FIGURE (C-1) The Fuel Cycle Cost per Batch where  $f = 0.01$

NO	TRANSACTION	DIRECT COST	DISCOUNTED COST
01	PAY FOR U308 (YELLOWCAKE)	\$ 8.911824E+06	\$ 9.781892E+06
02	PAY FOR CONVERSION OR COST OF UF6	\$ 3.897697E+05	\$ 4.090197E+05
03	PAY FOR SEPARATIVE WORK	\$ 4.425335E+06	\$ 4.643894E+06
04	PAY FOR PLUTONIUM	\$ 0.0	\$ 0.0
05	PAY FOR THORIUM	\$ 0.0	\$ 0.0
06	PAY FOR U-233	\$ 0.0	\$ 0.0
07	PAY FOR FABRICATION	\$ 3.410161E+06	\$ 3.473982E+06
08	PAY FOR SHIPPING FUEL TO REACTOR	\$ 0.0	\$ 0.0
09	PAY FOR	\$ 0.0	\$ 0.0
10	PAY FOR	\$ 0.0	\$ 0.0
11	PAY FOR SHIPPING FUEL TO REPROCESSING	\$ 5.044106E+05	\$ 4.469123E+05
12	PAY FOR REPROCESSING	\$ 0.0	\$ 0.0
13	PAY FOR WASTE DISPOSAL	\$ 5.044106E+06	\$ 4.370786E+06
14	PAY FOR CONVERSION OF UNH TO UF6	\$ 0.0	\$ 0.0
15	CREDIT FOR U308	\$ 0.0	\$ 0.0
16	CREDIT FOR CONVERSION OR FOR UF6	\$ 0.0	\$ 0.0
17	CREDIT FOR SEPARATIVE WORK	\$ 0.0	\$ 0.0
18	CREDIT FOR PLUTONIUM	\$ 0.0	\$ 0.0
19	CREDIT FOR THORIUM	\$ 0.0	\$ 0.0
20	CREDIT FOR U-233	\$ 0.0	\$ 0.0
21	PAY FOR	\$ 0.0	\$ 0.0
22	PAY FOR	\$ 0.0	\$ 0.0
23	CREDIT OR PENALTY FOR	\$ 0.0	\$ 0.0
24	CREDIT OR PENALTY FOR	\$ 0.0	\$ 0.0
25	CREDIT OR PENALTY FOR	\$ 0.0	\$ 0.0

THE LEVELIZED UNIT NUCLEAR FUEL COST PER BATCH = 9.096014

FIGURE (C-2) The Fuel Cycle Cost per Batch when MITCOST-II has been Modified  
(to set Z(15,3),Z(16,3)and Z(17,3) = 0)

## APPENDIX D

## MASS FLOWS CHARGED AND DISCHARGED

In this appendix the mass flows charged and discharged for each case studied are recorded. These results have for the most part been obtained using the LEOPARD program run by Garel (G-1) and Correa (C-2)

TABLE D.1  
 CHARGE AND DISCHARGE MASSES FOR THE  $UO_2^*$   
 (SLIGHTLY ENRICHED U-235) REACTOR

Case	A	B	C	D
Fuel-to-Coolant Volume Ratio	0.3380	0.4816	0.9161	1.497
Initial Fissile Enrichment	3.10	2.96	4.09	6.32
INITIAL INVENTORIES (kg/Initial MT HM)				
U-235	31.0	29.6	40.9	63.2
U-238	969.0	970.0	959.1	936.8
DISCHARGED INVENTORIES (kg/Initial MT HM)				
U-235	5.737	6.038	14.589	30.899
U-236	3.973	3.807	5.122	7.588
U-238	948.583	946.479	930.385	906.442
Pu-239	3.788	4.800	9.408	14.701
Pu-240	2.164	2.221	2.096	1.874
Pu-241	0.950	1.249	1.938	1.763
Pu-242	0.449	0.511	0.351	0.151

\*33000 MWD/MTHM discharged burnup, Zircaloy clad

TABLE D-2  
 CHARGE AND DISCHARGE MASSES FOR THE PuO<sub>2</sub>/UO<sub>2</sub> REACTOR\*

Case	A	B	C	D
Fuel-to-Coolant Volume Ratio	0.3380	0.4816	0.9161	1.497
INITIAL INVENTORIES (kg/INITIAL MT HM)				
Fissile Enrichment	2.78	2.97	8.51	8.80
U-235	1.924	1.918	1.755	1.747
U-238	960.063	957.315	875.967	871.673
Pu-239	20.610	22.103	66.298	68.631
Pu-240	9.867	0.582	31.741	32.858
Pu-241	5.298	5.681	17.041	17.641
Pu-242	2.237	2.399	7.197	7.450
DISCHARGED INVENTORIES (kg/INITIAL MT HM)				
U-235	0.694	0.805	1.087	1.008
U-236	0.219	0.220	0.193	0.217
U-238	941.578	935.472	851.924	844.313
Pu-239	6.578	10.188	55.568	60.954
Pu-240	7.346	5.889	22.650	27.233
Pu-241	4.254	5.889	20.834	18.746
Pu-242	4.138	3.971	7.349	7.513

\*33000 MWD/MTHM discharged burnup, Zircaloy clad

TABLE D-3

CHARGE AND DISCHARGE MASSES FOR THE  
 $UO_2$  (93% ENRICHED U-235)/ $ThO_2$  REACTOR\*

Case	A	B	C	D
Fuel-to-Coolant Volume Ratio	0.338	0.4816	0.916	1.497
INITIAL INVENTORIES (kg/INITIAL MT HM)				
Fissile Enrichment	3.95	3.82	4.47	6.47
U-235	39.538	38.208	44.729	64.689
U-238	2.976	2.876	3.367	4.869
Th-232	957.486	958.916	951.904	930.442
DISCHARGED INVENTORIES (kg/INITIAL MT HM)				
U-233	10.984	11.818	13.545	15.687
U-234	1.225	1.447	1.654	1.553
U-235	10.063	9.853	15.320	31.342
U-236	4.739	4.651	5.330	7.090
U-238	2.627	2.446	2.676	3.815
Th-232	934.616	933.618	924.315	902.390
Pu-239	0.073	0.089	0.177	0.424
Pu-240	0.035	0.034	0.039	0.056
Pu-241	0.021	0.029	0.060	0.101087
Pu-242	0.009	0.012	0.016	0.013
Pa-233	1.027	1.084	1.095	1.071

\*33000 MWD/MTHM discharged burnup, Zircaloy clad



TABLE D-4  
 CHARGE AND DISCHARGED MASSES FOR THE  $^{233}\text{UO}_2/\text{ThO}_2$  REACTOR (SEGREGATED)\*

Case	A	B	C	D
Fuel-to-Coolant Volume Ratio	0.3380	0.4816	0.9161	1.497
INITIAL INVENTORIES (kg/INITIAL MT HM)				
Fissile Enrichment	3.23	3.08	3.15	3.61
U-233	31.865	30.378	31.104	35.598
U-234	2.823	2.691	2.755	3.154
U-235	0.438	0.418	0.428	0.490
Th-232	964.870	966.513	965.713	960.759
DISCHARGED INVENTORIES (kg/INITIAL MT HM)				
U-233	18.079	18.345	21.174	26.982
U-234	5.052	4.956	5.088	5.498
U-235	1.145	1.662	1.672	2.040
U-236	0.205	0.234	0.260	0.283
Th-232	940.222	939.673	935.820	928.835
Pa-233	1.086	1.140	1.199	1.238

\*33000 MWD/MTHM Discharged Burnup, Zircaloy Clad

TABLE D-5

CHARGED AND DISCHARGED MASSES FOR TIGHT-LATTICE  
PITCH 233U/Th UNITS (SEGREGATED)

Fuel-to-moderator Volume Ratio	2.0	2.5	3.0
Fissile Enrichment	5.0	5.5	6.0
INITIAL INVENTORIES (kg/INITIAL MTHM)			
U-233	49.5	54.4	59.4
U-234	4.3	4.8	5.2
U-235	0.5	0.6	0.7
Th-232	945.7	940.3	934.8
DISCHARGED INVENTORIES (kg/INITIAL MTHM)			
U-233	41.3	48.3	55.1
U-234	6.6	7.2	7.6
U-235	2.1	2.1	2.0
U-236	0.2	0.2	0.2
Th-232	913.1	905.5	898.4
Pa-233	1.2	1.3	1.4

\*33000 MWD/MTHM discharged burnup, Zircaloy clad

TABLE D-6

MASS FLOWS CHARGED AND DISCHARGED  
 FOR 3 BATCH CORE, ZIRCALOY CLAD,  $V_f/V_m = 0.513$

<u>Discharged Burnup (MWD/MTHM)</u>	<u>8800</u>	<u>18000</u>	<u>33800</u>	<u>48200</u>	<u>62100</u>	<u>76000</u>
Initial Enrichment	1.5	2.0	3.0	4.0	5.0	6.0
Initial Inventory Charged (kg/Initial MTHM)						
$^{235}\text{U}$	15	20	30	40	50	60
$^{238}\text{U}$	985	980	970	960	950	940
Discharged Inventory (kg/Initial MTHM)						
$^{235}\text{U}$	7.63	6.55	5.93	5.66	5.40	4.99
$^{236}\text{U}$	1.23	2.23	3.88	5.39	6.81	8.16
$^{238}\text{U}$	977.32	965.57	045.43	027.12	909.56	892.3
$^{239}\text{Pu}$	3.18	4.09	4.80	5.17	5.38	5.40
$^{240}\text{Pu}$	0.87	1.58	2.25	2.59	2.81	2.97
$^{242}\text{Pu}$	0.07	0.22	0.50	0.83	1.12	1.33
$^{241}\text{Pu}$	0.3083	0.7432	1.2673	1.58	1.7906	1.9007

TABLE D-7

MASS FLOWS CHARGED AND DISCHARGED FOR THE 6 BATCH CORE ZIRCALOY CLAD  
 $V_f/V_m = 0.513$

Discharged Burnup (MWD/MTHM)	<u>10100</u>	<u>21000</u>	<u>34600</u>	<u>56000</u>	<u>73000</u>	<u>90500</u>
Initial Enrichment	1.5	2.0	3.0	4.0	5.0	6.0
Initial Inventories (kg/Initial MTHM)						
$^{235}\text{U}$	15	20	30	40	50	60
$^{238}\text{U}$	985	980	970	960	950	940
Discharged Inventories (kg/Initial MTHM)						
$^{235}\text{U}$	6.456	5.348	4.16	3.465	2.87	2.037
$^{236}\text{U}$	1.346	2.344	4.017	5.413	6.657	7.761
$^{238}\text{U}$	976.13	962.9	940.3	919.8	900.2	880.2
$^{239}\text{Pu}$	3.352	4.200	4.761	4.972	4.960	4.478
$^{240}\text{Pu}$	1.02	1.81	2.47	2.76	2.92	3.07
$^{241}\text{Pu}$	0.385	0.887	1.409	1.667	1.772	1.656
$^{242}\text{Pu}$	0.069	0.289	0.753	1.156	1.515	1.814

TABLE D-8

MASS FLOWS CHARGED AND DISCHARGED FOR THE 3 BATCH CORE  
<sup>233</sup>U/Th CYCLE\*, ZIRCALOY\*\* AND STAINLESS† STEEL CLAD

Fuel-to-Moderator Volume Ratio Clad	0.5		1.5		2.5	
	Zr	SS	Zr	SS	Zr	SS
Initial Inventories (kg/Initial MTHM)						
Fissile Enrichment	2.83	3.39	3.68	4.09	5.09	5.37
<sup>233</sup> U	27.99	33.7	36.39	40.47	50.36	53.11
<sup>234</sup> U	2.44	2.98	3.20	3.53	4.44	4.68
<sup>235</sup> U	0.29	0.39	0.38	0.43	0.58	0.57
<sup>232</sup> Th	969.28	962.08	960.03	955.57	944.62	941.64
Discharged Inventories (kg/Initial MTHM)						
<sup>233</sup> U	17.13	19.73	27.70	30.88	43.9	46.98
<sup>234</sup> U	4.73	5.21	5.53	5.85	6.71	6.97
<sup>235</sup> U	1.17	1.36	1.95	2.06	2.05	2.04
<sup>236</sup> U	0.21	0.21	0.26	0.25	0.25	0.24
<sup>232</sup> Th	941.15	938.10	928.17	924.59	910.39	907.05
<sup>233</sup> Pa	1.11	1.00	1.16	1.13	1.22	1.23

\*33000 MWD/MTHM discharged burnup

\*\*Zircaloy clad thickness = 26 mils

†SS clad thickness = 18 mils

TABLE D-9

MASS FLOWS CHARGED AND DISCHARGED FOR 3 BATCH CORE  
 STAINLESS CLAD (18 mils) ( $V_f/V_m = 0.513$ )

Discharged Burnup MWD/MTHM	<u>6000</u>	<u>22500</u>	<u>37100</u>	<u>50800</u>	<u>63800</u>
Initial Enrichment	2.0	3.0	4.0	5.0	6.0
Initial Inventories (kg/Initial MTHM)					
$^{235}\text{U}$	20	30	40	50	60
$^{238}\text{U}$	980	970	960	950	940
Discharged Inventories (kg/Initial MTHM)					
$^{235}\text{U}$	14.03	11.32	10.43	9.92	9.59
$^{236}\text{U}$	1.06	3.25	5.02	6.64	8.15
$^{238}\text{U}$	975.24	953.96	935.16	917.54	900.77
$^{239}\text{Pu}$	2.711	4.91	5.71	6.14	6.42
$^{240}\text{Pu}$	0.434	1.62	2.22	2.58	2.83
$^{241}\text{Pu}$	0.119	0.88	1.41	1.82	2.02
$^{242}\text{Pu}$	0.048	0.199	0.45	0.703	0.92

## APPENDIX E

## CALCULATION OF TRANSACTION QUANTITIES

In this appendix we describe the equations, methods and assumptions which have been used to obtain the quantity of each transaction in the nuclear fuel cycle. The mass flows charged and discharged are given in Appendix D.

## E.1 ONCE-THROUGH CYCLE

To obtain the transaction quantities for this mode, first we define

MHC = Kg heavy metal charged to reactor for each batch

MHD = Kg heavy metal discharged from reactor for each batch

XF = weight per cent of  $^{235}\text{U}$  charged to reactor

XW = weight per cent of  $^{235}\text{U}$  in the tails assay of the diffusion plant

$f_D$  = 1.0 - loss fraction in diffusion plant

$f_F$  = 1.0 - loss fraction in fabrication

$f_C$  = 1.0 - loss fraction in conversion to  $\text{UF}_6$

Then one can readily show:

$$M_{\text{U}_2\text{O}_8} = 2.6 \left( \frac{\text{MHC}}{f_D \cdot f_F \cdot f_C} \right) \left( \frac{\text{XF} - \text{XW}}{0.711 - \text{XW}} \right) \quad (\text{E.1})$$

$$M_{\text{UF}_6} = \left( \frac{\text{MHC}}{f_D \cdot f_C \cdot f_F} \right) \left( \frac{\text{XF} - \text{XW}}{0.711 - \text{XW}} \right) \quad (\text{E.2})$$

$$M_{\text{SW}} = \frac{\text{MHC}}{f_F \cdot f_D} \left[ \left( \frac{\text{XF}}{50} - 1 \right) \ln \frac{\text{XF}/100}{1 - \text{XF}/100} + \left( \frac{\text{XF} - 0.711}{0.711 - \text{XW}} \right) \left( \frac{\text{XW}}{50} - 1 \right) \right. \\ \left. \left( \ln \frac{\text{XW}/100}{1 - \text{XW}/100} \right) - 4.89 \left( \frac{\text{XF} - \text{XW}}{0.711 - \text{XW}} \right) \right] \quad (\text{E.3})$$

$$M_F = \frac{MHC}{f_D} \quad (E.4)$$

$$M_{TR} = MHD \quad (E.5)$$

$$M_{DIS} = MHD \quad (E.6)$$

where

$M_{U_3O_8}$  = ore requirement, lbs

$M_{UF_6}$  = Kg of uranium converted to  $UF_6$

$M_{SWU}$  = separative work needed, Kg SWU

$M_F$  = Kg of uranium fabricated

$M_{TR}$  = Kg of discharged uranium transported

$M_{Dis}$  = Kg of discharged uranium disposed of or stored and  
disposed of

All above quantities are for one batch.

## E.2 $^{235}U/U$ Cycle with Uranium and Plutonium Recycle

For this cycle credit due to discharged uranium and fissile Pu should be considered. The front-end transaction quantities can be found by using Equations (E.1) through (E.4). The back-end transaction quantities can be found as follows

$$M_{TR} = MHD \quad (E.5)$$

$$M_R = MHD \quad (E.7)$$

$$M_{WD} = MHD \quad (E.8)$$



where

$M_{TR}$  = Kg of discharged fuel transported to reprocessing plant

$M_R$  = Kg of discharge fuel reprocessed

$M_{WD}$  = Kg of fuel used as basis for waste disposal charges.

In considering the credit due to fissile plutonium, it should be noted that the reprocessed plutonium is a mixture of  $^{239}\text{Pu}$ ,  $^{240}\text{Pu}$ ,  $^{241}\text{Pu}$  and  $^{242}\text{Pu}$ .  $^{239}\text{Pu}$  and  $^{241}\text{Pu}$  are fissile isotopes of plutonium and  $^{240}\text{Pu}$  can be considered as fertile material (similar to  $^{238}\text{U}$ ). Since the weight per cent of  $^{240}\text{Pu}$  is small in discharged fuel we have taken this latter route and in effect ignored it.  $^{242}\text{Pu}$  is a poison and thus the credit for fissile plutonium should decrease due to the presence of  $^{242}\text{Pu}$  (similar to  $^{236}\text{U}$  in uranium). Thus at this point we proceed with a discussion on how to deal with the problem of penalizing the fissile material due to presence of a poison such as  $^{236}\text{U}$  or  $^{242}\text{Pu}$ .

Let's assume that there is a mixture of fissile material and poison with  $N_f$ , being the concentration of fissile material and  $N_p$  the concentration of poison. The question to be addressed is how many Kg of a mixture of fissile and poison have a reactivity worth equal to one Kg of the same fissile material in the absence of poison. To answer this question, the reactivity change can be written as

$$\frac{\Delta K}{K} = \frac{\Delta(\nu\Sigma_f - \Sigma_a)}{\nu\Sigma_f} = \frac{\Delta(\eta - 1)\Sigma_a}{\nu\Sigma_f} \quad (\text{E.9})$$

where

$K$  = multiplication factor

$\nu$  = number of neutrons produced per fission of each  
fissile nuclide

$\Sigma_f$  = fission macroscopic cross section

$\Sigma_a$  = absorption macroscopic cross section

$$\eta = \nu \Sigma_f / \Sigma_a$$

Thus to have equal reactivity worth with and without the existence of poison from Equation (E.9) one can write,

$$[(\eta-1)\Sigma_a]_{\text{without poison}} = [(\eta-1)\Sigma_a]_{\text{with poison}}$$

or

$$N_{\text{of}} \sigma_{\text{af}} (\eta_f - 1) = N_f \sigma_{\text{af}} (\eta_f - 1) + N_p \sigma_{\text{ap}} (\eta_p - 1) \quad (\text{E.10})$$

where  $N_{\text{of}}$  is the concentration of fissile nuclei in the absence of poison,  $\sigma_a$  and  $\sigma_f$  are microscopic absorption and fission cross sections respectively and  $N_f$  and  $N_p$  were defined before. Subscripts f and p are for fissile and poison, respectively. Hence with some manipulation, one can obtain:

$$\frac{N_f}{N_{\text{of}}} = \frac{1.0}{1 + \frac{N_p \sigma_{\text{ap}} (\eta_p - 1)}{N_f \sigma_{\text{af}} (\eta_f - 1)}} \quad (\text{E.11})$$

Now one can write

$$N_f = \frac{\left(\frac{m}{v}\right) \cdot w_f \times 6.025 \times 10^{23}}{M_f} \quad (\text{E.12})$$

$$N_{of} = \frac{\left(\frac{m}{v}\right) \cdot w_{of} \times 6.025 \times 10^{23}}{M_f} \quad (\text{E.13})$$

$$N_p = \frac{\left(\frac{m}{v}\right) \cdot w_p \times 6.025 \times 10^{23}}{M_p} \quad (\text{E.14})$$

where

$m$  = the weight of the mixture

$v$  = volume of the mixture, Kg

$w$  = the weight fraction

$M$  = molecular weight

Using Equations (E.12) through (E.14) in Equation (E.11) one can find

$$\frac{w_f}{w_{of}} = \frac{1.0}{1 + \frac{M_f}{M_p} \cdot \frac{w_p}{w_f} \left( \frac{\sigma_{ap}(\eta_p - 1)}{\sigma_{af}(\eta_f - 1)} \right)} \quad (\text{E.15})$$

Note that  $\left(\frac{m}{v}\right) w_i$  is the amount of isotope  $i$  in the mixture; therefore

Equation (E.15) can be written

$$\frac{M_f}{M_{of}} = \frac{1}{1 + \frac{M_f}{M_p} \cdot \frac{M_p}{M_f} \left( \frac{\sigma_{ap}(\eta_p - 1)}{\sigma_{of}(\eta_f - 1)} \right)} \quad (\text{E.16})$$

As already suggested (E.16) embodies the principle that  $m_f$  Kg of fissile material mixed with  $m_p$  Kg of poison has the same reactivity worth as  $m_{of}$  Kg of the same fissile material in the absence of poison.

Solving Equation (E.15) for  $w_{of}$  gives

$$w_{of} = w_f + \frac{M_f}{M_p} w_p \left[ \frac{\sigma_{ap}(\eta_p - 1)}{\sigma_{af}(\eta_f - 1)} \right] \quad (E.17)$$

which can be written as (note that  $\eta_p$  is less than 1.0)

$$\Delta w_f = w_f - w_{of} = - \frac{M_f}{M_p} \left[ \frac{\sigma_{ap}(\eta_p - 1)}{\sigma_{af}(\eta_f - 1)} \right] w_p \quad (E.18)$$

If we define

$$\xi = - \frac{M_f}{M_p} \left[ \frac{\sigma_{ap}(\eta_p - 1)}{\sigma_{af}(\eta_f - 1)} \right] \quad (E.19)$$

Equation (E.18) can be written as

$$\Delta w_f = \xi w_p \quad (E.20)$$

Equation (E.20) indicates that the penalty due to the presence of a poison is directly proportional to the weight per cent of poison in the mixture.

The constant of proportionality,  $\xi$ , can be found by using one group cross section data. However  $\xi$  can also be obtained by finding the slope of the trace of  $\Delta w_f$  versus  $w_p$ . For this purpose one zone of the Maine Yankee Core is considered and in the first step the feed enrichment is assumed to be 3 w/o with zero weight per cent of  $^{236}\text{U}$ . The dashed line in Figure (E.1) shows the

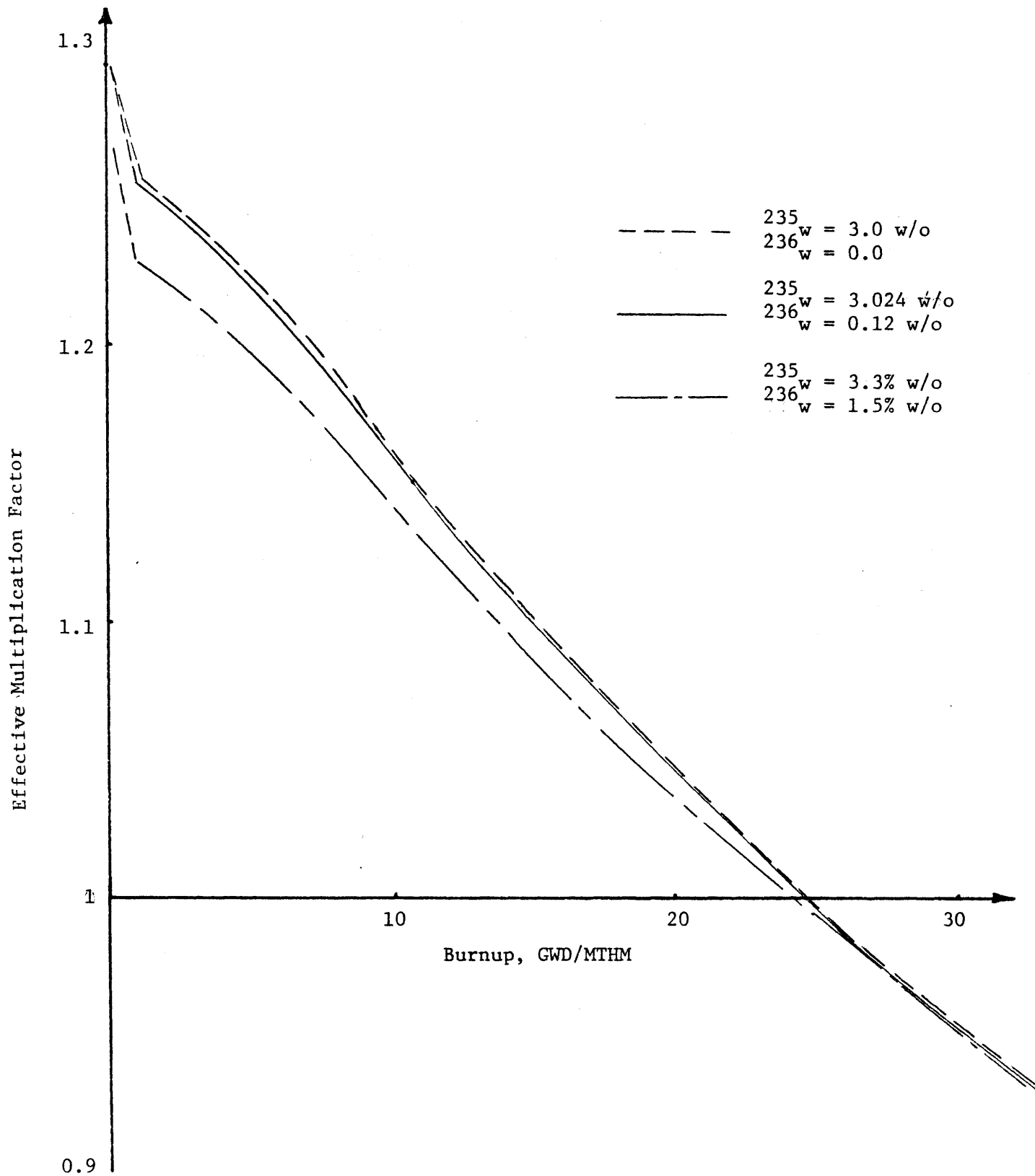

Figure E.1  $K_{\text{eff}}$  versus Burnup for Different Combinations of  $^{235}\text{U}$  and  $^{236}\text{U}$

$K_{\text{eff}}$  (effective multiplication factor) versus burnup, which has been obtained from the output of the LEOPARD code (B-1). Then the weight per cent of  $^{236}\text{U}$  is varied and at the same time the feed  $^{235}\text{U}$  enrichment is increased to yield the same discharged burnup as the case where there is no  $^{236}\text{U}$  in the fuel charged. Figure (E.1) shows the  $K_{\text{eff}}$  versus burnup for these cases. As can be seen, if the weight percent of  $^{236}\text{U}$  in charged fuel is equal to first 0.12 and then 1.5 weight per cent the feed enrichment has to be increased by 0.024 and 0.30 weight per cent  $^{235}\text{U}$  respectively, to yield enough positive reactivity to compensate for the negative reactivity due to the presence of  $^{236}\text{U}$  (and consequently give the same discharged burnup). Figure (E.2) shows  $\Delta w_f$  versus  $w_p$ . As can be seen this figure shows that for this case  $\xi = 0.2$

Consequently Equations (E.15) and (E.16) become, respectively for uranium mixtures:

$$w_{\text{of}} = w_f - 0.2 w_p \quad (\text{E.21})$$

$$m_{\text{of}} = m_f - 0.2 m_p \quad (\text{E.22})$$

The  $w$ 's in Equation (E.21) are in  $w/o$ . It should be noted that as  $V_f/V_m$  varies the neutron spectrum is changed and hence  $\xi$  is changed. However here we assume that  $\xi$  is constant and its variation with  $V_f/V_m$  is left for future work. For Pu mixtures (mixture of  $^{239}\text{Pu}$  and  $^{242}\text{Pu}$ ) Equation (E.19) was employed to determine  $\xi$  using one group cross sections;  $\xi$  for  $^{242}\text{Pu}$  in Pu mixtures was found to be 0.195.

Now we return to our theme, to find the credit from discharged fuel. The equivalent net mass of fissile plutonium, according to the above discussion can be written as

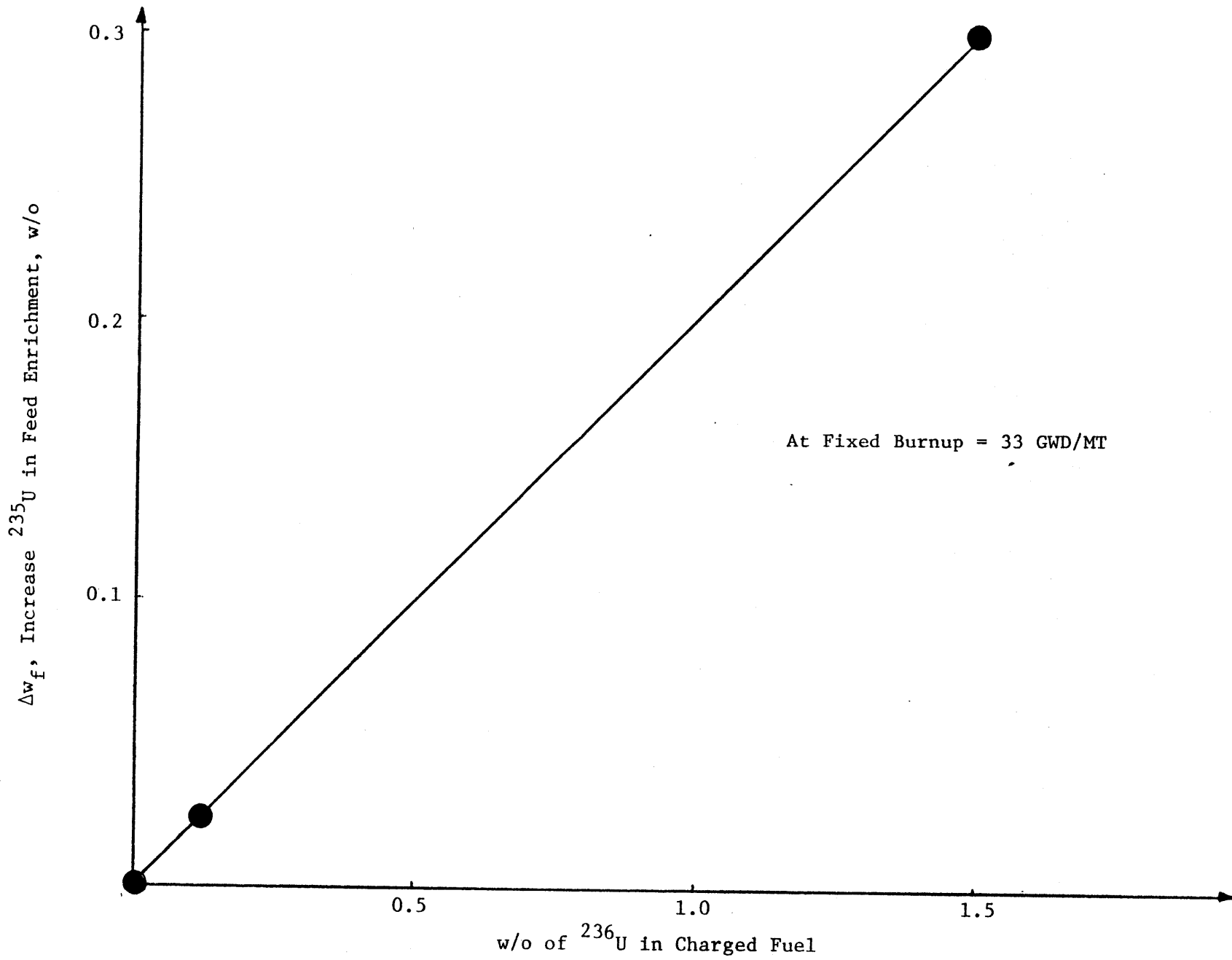

Figure E.2  $^{235}\text{U}$  Penalty in Fuel Charged to Reactor due to Presence of  $^{236}\text{U}$

$$M'_{\text{Pu}} = (M_{\text{Pu-39}} + \Psi M_{\text{Pu-41}} - 0.195M_{\text{Pu-242}}) f_{\text{R}} \quad (\text{E.23})$$

where

$M'_{\text{Pu}}$  = net mass of fissile plutonium (including the penalty due to presence of  $^{242}\text{Pu}$ )

$M_{\text{Pu-39}}$  = Amount of discharged  $^{239}\text{Pu}$ , Kg

$M_{\text{Pu-41}}$  = Amount of discharged  $^{241}\text{Pu}$ , Kg

$M_{\text{Pu-42}}$  = Amount of discharged  $^{242}\text{Pu}$ , Kg

$f_{\text{R}}$  = 1.0 - loss fraction in reprocessing plant

$\Psi$  in Equation (E.23) is the weighting factor given in reference (G-1).

The value of  $\Psi$  varies with  $V_{\text{f}}/V_{\text{m}}$  and it is very close to 1.0 (1.09 for  $V_{\text{f}}/V_{\text{m}} = 0.4816$ ).

To determine the credit due to discharged uranium one of the methods discussed in Section 4.2 of Chapter 4 can be used.

### E.3 $^{235}\text{U}/\text{Th}$ Cycle

The ore requirement and the quantities handled in the other steps in the front end of the fuel cycle can be calculated by using Equations (E.1) through (E.4). For the segregated case, where  $^{235}\text{U}$  can be separated from  $^{233}\text{U}$ , one of the methods given in section (4.2) of Chapter 4 can be used to penalize the credit for the discharged uranium due to the presence of  $^{236}\text{U}$ .

To determine the credit for the sale of fissile material, since  $^{233}\text{Pu}$  has a short half life, its amount in the discharged fuel has been directly added to the quantity of discharged  $^{233}\text{U}$ . For this cycle, since the quantities of discharged plutonium isotopes are very small, they were ignored. Therefore the equivalent mass of fissile  $^{233}\text{U}$  for this option can be written as



$$M'_{U3} = M_{U-233} + M_{Pa-233} \quad (E.24)$$

where

$$\begin{aligned} M'_{U3} &= \text{the equivalent mass of fissile U-233} \\ M_{U-233} &= \text{Kg of } ^{233}\text{U discharged from the reactor} \\ M_{Pa-233} &= \text{Kg of } ^{233}\text{Pa discharged from the reactor} \end{aligned}$$

$^{234}\text{U}$  in discharged fuel is treated as a fertile material (with capture of one neutron it becomes fissile  $^{235}\text{U}$ ). Hence its quantity was added to the amount of discharged  $^{232}\text{Th}$  using a weighting factor. For calculating this weighting factor, we assume the capture rates of "equivalent"  $^{234}\text{U}$  and  $^{232}\text{Th}$  should be equal. Thus one can write

$$N_{U-4} \sigma_{U-4}^C = N_{Th} \sigma_{Th}^C \quad (E.25)$$

where  $N_{U-4}$  and  $N_{Th}$  are the number of atoms of  $^{234}\text{U}$  and  $^{232}\text{Th}$  in the mixture respectively and  $\sigma^C$  are microscopic capture cross sections for each nuclide, as subscripted. Equation (E.25) can be written as

$$\frac{M_{U-4}}{234} \cdot \sigma_{U-4} = \frac{M_{Th}}{232} \cdot \sigma_{Th} \quad (E.26)$$

where  $M_{U-4}$  and  $M_{Th}$  are the amount of  $^{233}\text{U}$  and  $^{232}\text{Th}$  in the mixture. Therefore Equation (E.26) can be solved for  $M_{Th}$  to find the amount of thorium which is equivalent to a quantity of  $^{234}\text{U}$  from the point of view of the capability of breeding fissile material. Hence,

$$M_{Th} = \frac{\sigma_{U-4}}{\sigma_{Th}} \frac{232}{234} M_{U-4} = \phi_{U-4} \quad (E.27)$$

Note that an equation similar to Equation (E.27) can be found for any other fertile material. For example  $^{240}\text{Pu}$  can be treated as a fertile material and the amount of equivalent  $^{238}\text{U}$  per unit mass of  $^{240}\text{Pu}$  can be written as

$$\frac{M_{U-8}}{M_{Pu-40}} = \frac{\sigma_{Pu-40}^C}{\sigma_{U-8}^C} \cdot \frac{238}{242} \quad (E.28)$$

Using one group cross sections,  $\phi$  in Equation (E.27) is found to be equal to 19.0. Thus the equivalent mass of discharged thorium can be written as;

$$M'_{Th} = M_{Th-232} + 19.0 M_{U-4} \quad (E.29)$$

where

$M'_{Th}$  = Kg equivalent thorium in discharged fuel

$M_{Th-232}$  = Kg of thorium discharged

$M_{U-4}$  = Kg of  $^{234}\text{U}$  discharged

For the non-segregated scenario, as discussed before, the  $^{235}\text{U}$  and  $^{233}\text{U}$  cannot be separated, and thus there is no credit due to ore or separative work. The credits for fissile materials were considered by adding the discharged amount of  $^{233}\text{U}$ ,  $^{235}\text{U}$  and  $^{233}\text{Pa}$ . The weight per cent of  $^{235}\text{U}$  was decreased using the method discussed previously to consider the penalty due to presence of  $^{236}\text{U}$ . We did not however account for the difference between  $^{233}\text{U}$  and  $^{235}\text{U}$ , a refinement recommended for future work.

E.4  $^{233}\text{U}/\text{Th}$  and Pu/U Cycle

The transaction quantities for these cycles were calculated under the same assumptions discussed previously. The discharged quantities of  $^{233}\text{U}$  from  $^{233}\text{U}/\text{Th}$  units and fissile plutonium from Pu/U units were determined employing the same methods used for calculation of these quantities in discharged fuel from  $^{235}\text{U}/\text{Th}$  units and  $^{235}\text{U}/\text{U}$  units respectively. The quantities of  $^{240}\text{Pu}$  and  $^{234}\text{U}$  in discharged fuel were added to the quantities of  $^{238}\text{U}$  and  $^{232}\text{Th}$ , using Equations (E.27) and (E.28).

## E.5 Tables of Transaction Quantities

Tables (E.1) through (E.9) show the transaction quantities which have been used for calculation of levelized fuel cycle cost. The parameters used in these tables are:

$M_{\text{U}_3\text{O}_8}$  = ore requirement, lbs.

$M_{\text{UF}_6}$  = Kg of uranium converted to  $\text{UF}_6$

$M_{\text{SWU}}$  = separative work needed, Kg SWU

$M_{\text{F}}$  = Kg uranium fabricated

$M_{\text{TR}}$  = Kg of discharged uranium transported

$M_{\text{WD}}$  = Kg of discharged uranium disposed of or stored and disposed of, or Kg used as basis of waste disposal charges

$M_{\text{R}}$  = Kg of discharged fuel reprocessed

$M'_{\text{U}_3\text{O}_8}$  = ore credit from discharged fuel, lbs

$M'_{\text{UF}_6}$  = credit for uranium conversion to  $\text{UF}_6$  from discharged fuel, Kg

$M'_{\text{SWU}}$  = credit for separative work from discharged fuel, Kg SWU

$M'_{Pu}$  = Fissile plutonium credit, Kgs

$M'_{U3}$  =  $^{233}U$  credit, Kgs

$M_{Pu}$  = Fissile plutonium requirement for charge to the reactor

$M_{U3}$  =  $^{233}U$  requirement for feed charged to the reactor

$M_{U8}$  =  $^{238}U$  charged to the reactor (for Pu/U units) lbs

$M'_{U8}$  =  $^{238}U$  discharged from the reactor (for Pu/U units), lbs

$M_{Th}$  = Th charged to the reactor (for  $^{233}U/Th$  units), lbs

$M'_{Th}$  = Th discharged from the reactor (for  $^{233}U/Th$  units)

(including equivalent  $^{234}U$ ), lbs

Note that all quantities introduced are per batch, and ore and separative work were calculated on the basis of 0.2 w/o tails assay for the diffusion plant.

TABLE E.1

TRANSACTION QUANTITIES  $^{235}\text{U}/\text{U}$  UNIT, 3 BATCH CORE

Transaction	$V_f/V_m = 0.338$	$V_f/V_m = 0.4816$	$V_f/V_m = 0.9161$	$V_f/V_m = 1.497$
$M_{\text{U}_3\text{O}_8}$	441060.0	419768.0	591629.0	930789.0
$M_{\text{UF}_6}$	169639.0	159835.0	22755.0	357996.0
$M_{\text{SWU}}$	133933.0	124853.0	199721.0	354021.0
$M_{\text{F}}$	29593.0	29593.0	29593.0	29593.0
$M_{\text{TR}}$	28290.0	28274.0	28239.0	282550
$M_{\text{R}}$	28290.0	28274.0	28239.0	282550
$M_{\text{WD}}$	28290.0	28274.0	28239.0	282550
$M'_{\text{U}_3\text{O}_8}$	47532.0	51776.0	177596.0	4159590
$M'_{\text{SWU}}$	-4219.0	-3544.0	31518.0	1298830
$M'_{\text{F}}$	18281.7	20115.0	68306.0	1599980
$M'_{\text{Pu}}$	139.1	177.3	332.0	4835

TABLE E.2

## TRANSACTION QUANTITIES FOR Pu/U UNITS, 3 BATCH CORE

<u>Transaction</u>	<u><math>V_f/V_m = 0.338</math></u>	<u><math>V_f/V_m = 0.4816</math></u>	<u><math>V_f/V_m = 0.9161</math></u>	<u><math>V_f/V_m = 1.497</math></u>
$M_{U_8}$	155716.0	68048.4	332432.0	365671.0
$M_{Pu}$	768.2	824.3	2439.8	2547.6
$M_F$	29592.0	29592.0	29592.0	29592.0
$M_{TR}$	28265.0	28196.0	28113.0	28124.0
$M_{WD}$	28265.0	28196.0	28113.0	28124.0
$M_R$	28265.0	28196.0	28113.0	28124.0
$M'_{U_8}$	127846.0	11404.0	263028.0	304740.0
$M'_{Pu}$	302.0	460.1	21926.0	2290.4

TABLE E-3

TRANSACTION QUANTITIES FOR  $^{235}\text{U}(93\%)/\text{Th}$ , 3 BATCH CORE

Transaction	$V_f/V_m = 0.338$	$V_f/V_m = 0.4816$	$V_f/V_m = 0.9161$	$V_f/V_m = 1.497$
$M_{\text{U}_3\text{O}_8}$	510980.0	493822.0	578104.0	836073.0
$M_{\text{Th}}$	53198.0	53278.0	52888.0	51696.0
$M_{\text{UF}_6}$	196542.0	189931.0	222348.0	321567.0
$M_{\text{SWU}}$	252375.0	243886.0	285512.0	412915.0
$M_{\text{F}}$	25202.0	25202.0	25202.0	25202.0
$M_{\text{TR}}$	24086.0	24078.0	24057.0	24040.0
$M_{\text{R}}$	24086.0	24078.0	24057.0	24040.0
$M_{\text{WD}}$	24086.0	24078.0	24057.0	24040.0
$M'_{\text{U}_3\text{O}_8}$	117546.0	115070.0	182401.0	376947.0
$M'_{\text{UF}_6}$	41085.0	44257.6	70154.0	14498.0
$M'_{\text{SWU}}$	56967.0	55785.5	89032.0	18515.3
$M'_{\text{U}_3}$	299.7	321.9	265.3	418.1
$M'_{\text{Th}}$	54479.0	52347.0	52056.0	51270.0

TABLE E.4

TRANSACTION QUANTITIES FOR  $^{233}\text{U}/\text{Th}$  UNITS, THREE BATCH CORE

Transaction	$V_f/V_m = 0,338$	$V_f/V_m = 0.4816$	$V_f/V_m = 0.9161$	$V_f/V_m = 1.497$
$M_{\text{U}_3}$	805.0	767.0	785.8	899.3
$M_{\text{Th}}$	56042.0	53298.0	56017.0	56164.3
$M_{\text{F}}$	25202.0	25202.0	25202.0	25202.0
$M_{\text{TR}}$	24096.0	24101.7	24082.0	24073.0
$M_{\text{R}}$	24096.0	24101.7	24082.0	24073.0
$M_{\text{WD}}$	24096.0	24101.7	24082.0	24073.0
$M'_{\text{U}_3}$	504.2	524.0	569.0	750.5
$M'_{\text{Th}}$	57031.3	56900.2	56827.0	56874.0



TABLE E.5

TRANSACTION QUANTITIES FOR  $^{233}\text{U}/\text{Th}$  UNITS, 3 BATCH CORE (tight-lattice pitch)

<u>Transaction</u>	<u><math>V_f/V_m = 2.0</math></u>	<u><math>V_f/V_m = 2.5</math></u>	<u><math>V_f/V_m = 3.0</math></u>
$M_{\text{U}_3}$	1247.5	1372.3	1497.1
$M_{\text{Th}}$	55212.0	56771.0	56890.0
$M_{\text{F}}$	25202.0	25202.0	25202.0
$M_{\text{TR}}$	24064.0	24066.0	24069.0
$M_{\text{R}}$	24064.0	24066.0	24069.0
$M_{\text{WD}}$	24064.0	24066.0	24069.0
$M'_{\text{U}_3}$	1112.8	1290.1	1459.6
$M'_{\text{Th}}$	27169.0	57383.0	57413.0

TABLE E.6

TRANSACTION QUANTITIES FOR  $^{235}\text{U}/\text{U}$  CYCLE 3 BATCH-ZIRCALOY CLAD

Discharged Burnup	<u>8800</u>	<u>18000</u>	<u>33800</u>	<u>48200</u>	<u>62100</u>	<u>76000</u>
$M_{\text{U}_3\text{O}_8}$	194220.3	268920.3	418320.5	567720.6	717121.0	866521.0
$M_{\text{UF}_6}$	74700.1	103430.7	160892.5	218353.8	275815.8	333277.3
$M_{\text{SWU}}$	35835.0	64104.1	125818.8	191182.4	258588.4	327314.1
$M_{\text{F}}$	28923.9	28923.9	28293.9	28923.9	28923.9	28923.9
$M_{\text{TR}}$	28339.8	28084.3	27591.7	26975.9	26600.5	26138.4
$M_{\text{R}}$	28339.8	28084.3	27591.7	26975.9	26600.5	26138.4
$M_{\text{WD}}$	28339.8	28084.3	27591.7	26975.9	26600.5	26138.4
$M'_{\text{U}_3\text{O}_8}$	79244.0	59123.0	46649.0	40951.0	34922.0	27058.0
$M'_{\text{UF}_6}$	2240.0	-6158.0	-9409.0	-11113.0	-12962.0	-15522.6
$M'_{\text{SWU}}$	-9186.8	7935.0	18329.0	21051.0	213074.0	25814.0
$M'_{\text{Pu}}$	100.6	139.6	174.2	192.8	203.7	206.7

TABLE E.7

## TRANSACTIONS QUANTITIES OF THE 6 BATCH CORE, ZIRCALOY CLAD

Discharged Burnup MWD/MTHM	<u>10100</u>	<u>21000</u>	<u>39600</u>	<u>56600</u>	<u>73000</u>	<u>90500</u>
$M_{U_3O_8}$	97110.5	1334460.8	209161.0	283861.0	35856.1	433262.5
$M_{UF_6}$	37346.1	513253.8	80446.1	109177.3	137908.5	166639.2
$M_{SWU}$	17917.7	32052.2	62910.0	95591.6	129294.8	163657.8
$M_F$	14462.0	14462.0	14462.0	14462.0	14462.0	14462.0
$M_{TR}$	14163.6	14000.0	13715.0	13447.4	13184.8	12902.4
$M_R$	14163.6	14000.0	13715.0	13447.4	13184.8	12902.4
$M_{WD}$	14163.6	14000.0	13715.0	13447.4	13184.8	12902.4
$M'_{U_3O_8}$	37387.0	21200.1	12341.0	7308.5	3629.0	443.9
$M'_{UF_6}$	285.3	- 5742.0	-8833.0	-10484.0	-11628.0	-12572.0
$M'_{SWU}$	-473.0	16946.0	19260.0	28847.0	29585.0	25543.0
$M'_{Pu}$	53.8	73.16	88.05	93.92	94.5	84.5

TABLE E.8-

## TRANSACTION QUANTITIES OF THE THREE BATCH REACTOR

$V_f/V_m =$	0.5		1.5		2.5	
	Zr	SS	Zr	SS	Zr	SS
$M_{U3}$	759.53	915.57	987.55	1098.47	1368.125	1441.98
$M_{Th}$	60151.5	60391.7	60467.9	60577.52	60959.7	6105.5
$M_F$	2658.9	2658.9	2658.9	2658.9	2658.9	2658.9
$M_{TR}$	25671.7	25674.6	25652.3	25652.0	25644.4	25645.35
$M_R$	25671.7	25674.6	25652.3	25652.0	25644.4	25645.3
$M_{WD}$	25671.7	25674.6	25652.3	25652.0	25644.4	25645.3
$M'_{U3}$	516.1	587.6	819.2	905.88	1254.2	1336.1
$M'_{Th}$	60472.0	60831.0	60677.8	60756.7	60888.4	60984.0

TABLE E.9

TRANSACTION QUANTITIES FOR THREE BATCH AND STAINLESS STEEL CLAD (ONCE THROUGH MODE)

Discharged Burnup <u>MWD/MTHM</u>	<u>6000</u>	<u>22500</u>	<u>37100</u>	<u>50800</u>	<u>63800</u>
$M_{U_3O_8}$	268920.0	418320.5	567720.7	717121.0	866521.0
$M_{UF_6}$	103430.7	160892.5	218353.8	275815.8	333277.3
$M_{SWU}$	641041.0	125818.8	191182.4	258588.4	327314.1
$M_F$	28923.9	28923.9	28923.9	28923.9	28923.9
$M_{TR}$	28541.8	27946.6	27487.8	27049.8	26624.5
$M_{WD}$	28451.8	27946.6	27487.8	27049.8	26624.5

## APPENDIX F

## TREATMENT OF INFLATION (D-5)

Consider the cash flow diagram of Figure (F-1)

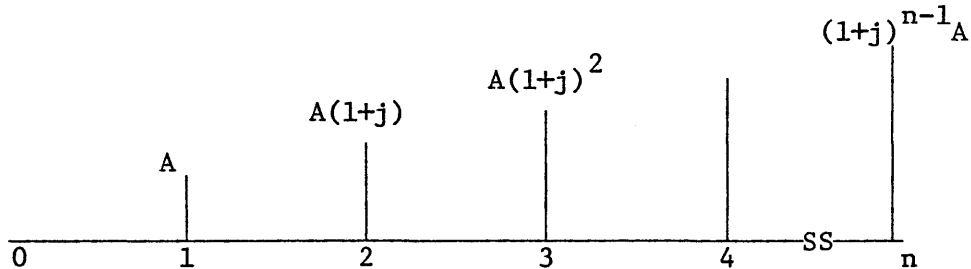

Figure (F-1) Cash Flow Diagram

In this figure  $A$  is the payment or credit at the end of the first year. If we assume payments at the end of each period increase by a factor  $(1+j)$  with respect to the previous payment, where  $j$  is the inflation rate, at the end of the  $n^{\text{th}}$  year the payment or credit is  $(1+j)^{n-1}A$ . The reference payment (or credit),  $A$ , can be expressed in time-zero dollars as

$$A = A_0(1 + j) \quad (\text{F.1})$$

where  $A_0$  is the amount in time-zero dollars.

The present worth,  $P$ , of this geometric gradient series is given as (A.5)

$$P = A \left[ \frac{1 - (1+j)^n(1+i)^{-n}}{i-j} \right] \quad i \neq j \quad (\text{F.2})$$

where  $i$  is the effective interest per period. Using Equation (F.1) in Equation (F.2) gives

$$P = A_o \frac{1 + \left(\frac{1+i}{j+j}\right)^{-n}}{\left(\frac{i-j}{1+j}\right)} \quad (\text{F.3})$$

Define

$$i_b = \frac{i-j}{1+j} \quad (\text{F.4})$$

which can be written

$$(1+i) = (1+i_b)(1+j) \quad (\text{F.5})$$

Employing Equation (F.4) in Equation (F.3) one finds

$$(P/A_o) = \frac{1 - (1+i_b)^{-n}}{i_b} \quad (\text{F.6})$$

Equation (F.6) has the same form as when we have an annuity series (uniform series), where all payments (or credits) are equal.

Therefore, the present worth of a geometric gradient series with an inflated discount rate,  $i$ , is equal to the present worth of a uniform series with a deflated discount rate of  $i_b$ .

To show the equivalence between these two treatments, a deflated discount rate of 9 %/yr was considered (with the data given in Table (2.4)) together with an inflation rate of 6%/yr ( $j$ ). Then using Equation (F.5)  $i$ , the inflated discount rate, was calculated to be 14.04%/yr. Next the fuel cycle cost of the base case (see Chapter 2) was calculated using a 6%/yr escalation rate for all steps of the fuel cycle (including the price of electricity) and applying the inflated discount rate of 14.04%/yr. The result from SIMMOD gave  $\sim 5.800$  mills/kwhre for this case. When no

escalation rate was considered for any steps of the nuclear fuel cycle, and a deflated discount rate of 9%/yr was used, the fuel cycle cost calculated, using SIMMOD, was 5.717 mills/kwhre. The  $\sim 1.5\%$  difference is due to the assumptions embodied in SIMMOD: a more exact model would give exact equivalence. Note that MITCOST-II cannot be used to test this assertion since the consideration of an escalation rate for the price of electricity is not allowed in that program.



## REFERENCES

- A-1 Asmusse K. E., R. H. Brogli, S. E. Nowicki, and D. B. Southworth, "A Manual on Fuel Cycle Cost Calculation and Description of the Code: GACOST", Gulf-GA-A 10593, October 1, 1972
- A-2 "Reprocessing - Recycle Economics", Atomic Industrial Forum, Inc. (AIF), November 10, 1977
- A-3 Abtahi, F., "Out-of-Reactor Aspects of Thorium Utilization in Light Water Reactors", Ph.D. Thesis, MIT Nuclear Eng. Dept., July, 1977
- A-4 Andrews, H. N., et. al., "Optimizing the Refuel Cycle: Two Views", Nuclear News, September, 1973
- A-5 Agee, H. M., J. A. White and K. E. Case, "Principles of Engineering Economic Analysis", John Wiley & Sons, NY, 1977
- B-1 Barry, R. F., "LEOPARD, A Spectrum Dependent Non-Spatial Depletion Code for the IBM-7094", WCAP-3269-26
- B-2 Benedict, M., "An Economic Appraisal of Stainless Steel and Zirconium in Nuclear Reactors", Metal Progress, February, 1959
- B-3 Beecher, N., Benedict, M., "Which for Minimum Fuel Cost - Zircaloy or Stainless Clad?", Nucleonics, Vol. 17, No. 7, p. 64, July, 1959
- B-4 Beecher, N., M. Benedict, "Comparative Fuel Costs for Pressurized Water Reactor with Zircaloy or Stainless Steel Fuel Cladding", Columbia-National Corporation, October, 1958
- C-1 Croff, A. G., "MITCOST-II - A Computer Code for Nuclear Fuel Cycle Costs", N. E. Thesis, MIT, Nuclear Eng. Dept., 1974
- C-2 Correa, F., Doctoral Thesis, MIT Nuclear Engineering Dept, in progress, June 1979 (estimated)
- C-3 Correa, F., "Effect of  $^{232}\text{Th}/^{238}\text{U}$  Ratio on the Conversion Ratio of PWR's", Aug, 1977, MIT Nuclear Eng. Dept., unpublished paper
- D-1 DeGarmo, E. P., Canada J. R., "Engineering Economy", Fifth edition, Macmillan Publ. Co., Inc., NY, 1973
- D-2 "Preliminary Estimation of the Charge for Spent Fuel Storage and Disposal Services", DOE/ET-0055, July, 1978
- D-3 Driscoll, M. J., Class Notes, MIT Subject No. 22-35 Fuel Management, Spring, 1978
- D-4 Driscoll, M. J., Class Notes, MIT Subject No. 22-34, Economics of Nuclear Power, Fall, 1977
- F-1 Fulford, P. J., S. R. Casey, and R. Swanson, "Nuclear Fuel Management for Utilities", Proc. Amer. Power Conf. 30, 276-281, July, 1969

- F-2 Frankel, A. J. and Shapiro, N. L., "Appraisal of PWR-HWR Tandem Fuel Cycle" NPSD-45, Combustion Eng. Inc., February, 1977
- F-3 Fujita, E. K., M. J. Driscoll and D. D. Lanning, "Design and Fuel Management of PWR Cores to Optimize the Once-Through Fuel Cycle", MIT, Nuclear Eng. Dept., MITNE-215, August, 1978
- G-1 Garel, Keith and M. J. Driscoll, "Fuel Cycle Optimization of Thorium and Uranium Fueled PWR Systems", MIT Nuclear Engineering Dept., October, 1977
- G-2 Ghahramani, K. and M. J. Driscoll, "Ore Price Escalation in Fuel Cycle Economic Analyses", Trans. Am. Nucl. Soc., Vol. 28, June, 1978
- G-3 Ghahramani, K., "An Analysis of Prospective Nuclear Fuel Cycle Economics", Nucl. Eng. Thesis, MIT, Nuclear Eng. Dept., September, 1978
- G-4 Goodman, E. I., Walton, R. D., "The Potential for Using Blending to Upgrade Reprocessed Uranium", Trans. Am. Nucl. Soc., Vol. 11, page 33
- G-5 Green, A. E., Bourne, A. J., "Reliability Technology", John Wiley & Sons, March 1973
- G-6 GESMO, Chapter VIII, Volume 4, Appendix B, 1976
- G-7 Gueron, H. M., Geller, L., (Isotopic Composition Along a Diffusion Cascade with Post Irradiation Recycle Flow. Effect of the presence of  $^{236}\text{U}$  on the separative work), Trans. Am. Nucl. Soc., Vol. 11, page 34.
- H-1 Hughes, J. A. and Hang, D. F., "Program GEM, General Economic Model to Analyze Nuclear Fuel Cycle Costs", University of Illinois, September, 1973
- H-2 Sprague, H. O., "Fuel Cycle Effect of  $^{236}\text{U}$  in Recycled Uranium", Trans. Am. Nucl. Soc., June, 1974, p. 179
- K-1 Kim, Y. S., "FUELCOST-I, A Program for Calculating Nuclear Fuel Cycle Cost from Burnup Data", NUS 351, (1967)
- K-2 Kasten, P. R., Homan F. J. et. al., "Assessment of the Thorium Fuel Cycle in Power Reactors", ORNL/TM-5565, January, 1977
- L-1 Lee, D. H., Jr., "PWCOST - A General Purpose Computer Code for Calculation of Fuel Cycle Cost", GA-9394 (1969)
- L-2 Latts, A. L., Washburn, T. H., Haman, F. J., "FABCOST 9, A Computer Code for Estimating Fabrication Costs for Rod-Bundle Fuel Elements", ORNL-4287, August, 1968
- M-1 "Metals Week, 1976 Price Handbook", McGraw Hill Publications

- O-1 Oso, J. B., "The Proper Role of the Tax-Adjusted Cost of Capital in Present Value Studies", The Engineering Economist, Vol. 24, No. 1, Fall 1978
- P-1 Private Communication with Physics Division of C.E.
- R-1 Rosito, A.R., "Nuclear Merchant Ships for Argentina: An Analysis of Prospective Advantages and Economics", S.M. Thesis, MIT Nuclear Eng. Dept., March 1978.
- S-1 Smith G. W., "Engineering Economy: Analysis of Capital Expenditures" second edition, Iowa State University Press, 1973, p. 240.
- S-2 Salman, R., "Two Computer Codes (REFCO, POW 76) for Calculating the Fuel Cycle Cost of a Nuclear Power Reactor", ORNL 4695 (1971).
- S-3 Matzie, R. A., Rec. J. R., "Assessment of Thorium Fuel Cycles in Pressurized Water Reactors", TIS-5114, November 1976
- S-4 Stauffer, T. R., Palmer, R. S., Wychoff, H. L., "Breeder Reactor Economics"
- S-5 "Survey of Financial Reporting and Accounting Developments in the Public Utility Industry", Price Waterhouse & Co., 1978
- V-1 Vondy, D. R., "Basis and Certain Features of the Discount Technique", ORNL 3686, Appendix F, pp. 243-248, 1965
- X-1 Brehm, R. L., Spriggs, G., "Nuclear Fuel Cycle Economic Analysis: An Evaluation of Computer Codes", unpublished paper, September, 1975